

36W USB charger with selectable output voltage (5-9-12 V @3A) based on STCH03L and SRK1000B

Data brief

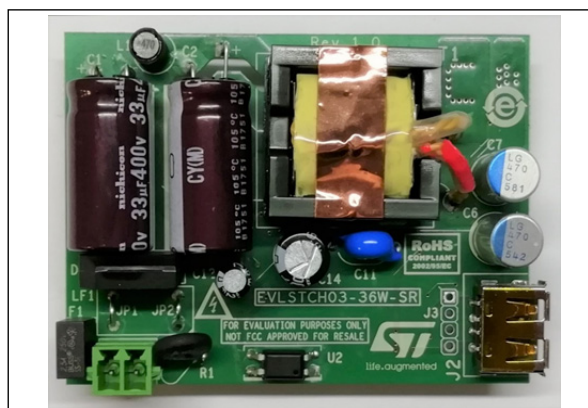

The power circuit is a quasi-resonant (QR) flyback converter, with peak current mode control, based on the STCH03L IC. The circuit operates with secondary side constant voltage (CV) regulation through an optocoupler and is capable of providing constant output current (CC) regulation using primary sensing feedback.

The STCH03L embeds a 650 V, non-dissipative, HV startup cell, which, along with the extremely low quiescent current and burst-mode management, helps minimize residual input consumption, thus achieving less than 20 mW under no-load condition.

At secondary side, the SRK1000B controller implements synchronous rectification to increase system efficiency: it controls the synchronous rectifier MOSFET, driving its gate with minimal turn-on delay and maximizing the turn-off time instant (through an adaptive mechanism) so that the residual conduction of the SR MOSFET body diode after turn-off reduces to the target value of 300 ns.

The charger is designed to meet the most stringent energy saving recommendations (Eu CoC rev. 5 - Tier 2 and EPS of DOE USA) as well as EMI regulation EN55022-Class-B for line conducted noise emissions.

Features

- Universal AC mains input voltage range: 90 V to 264 V
- Output voltage: 5 - 9 - 12 V selectable @3 A continuous operation
- Constant voltage (CV) regulation with optocoupler and constant current (CC) regulation with primary side sensing
- No-load consumption < 20mW at 230 VAC (with load disconnected from charger)
- 4 points average efficiency and 10% load efficiency in compliance with Eu CoC rev. 5 - Tier 2 (2016)
- Line conducted EMI in compliance with EN55022 - Class B
- Small form factor (73 x 55 x 15 mm)
- RoHS compliant

Description

The EVLSTCH03-36W-SR shown in the image here is a 36 W wide-range mains USB charger demonstration board, with selectable output voltage (5 - 9 - 12 V @ 3 A output current), based on the STCH03L and SRK1000B.

1 Electrical diagram

Figure 1. Electrical diagram

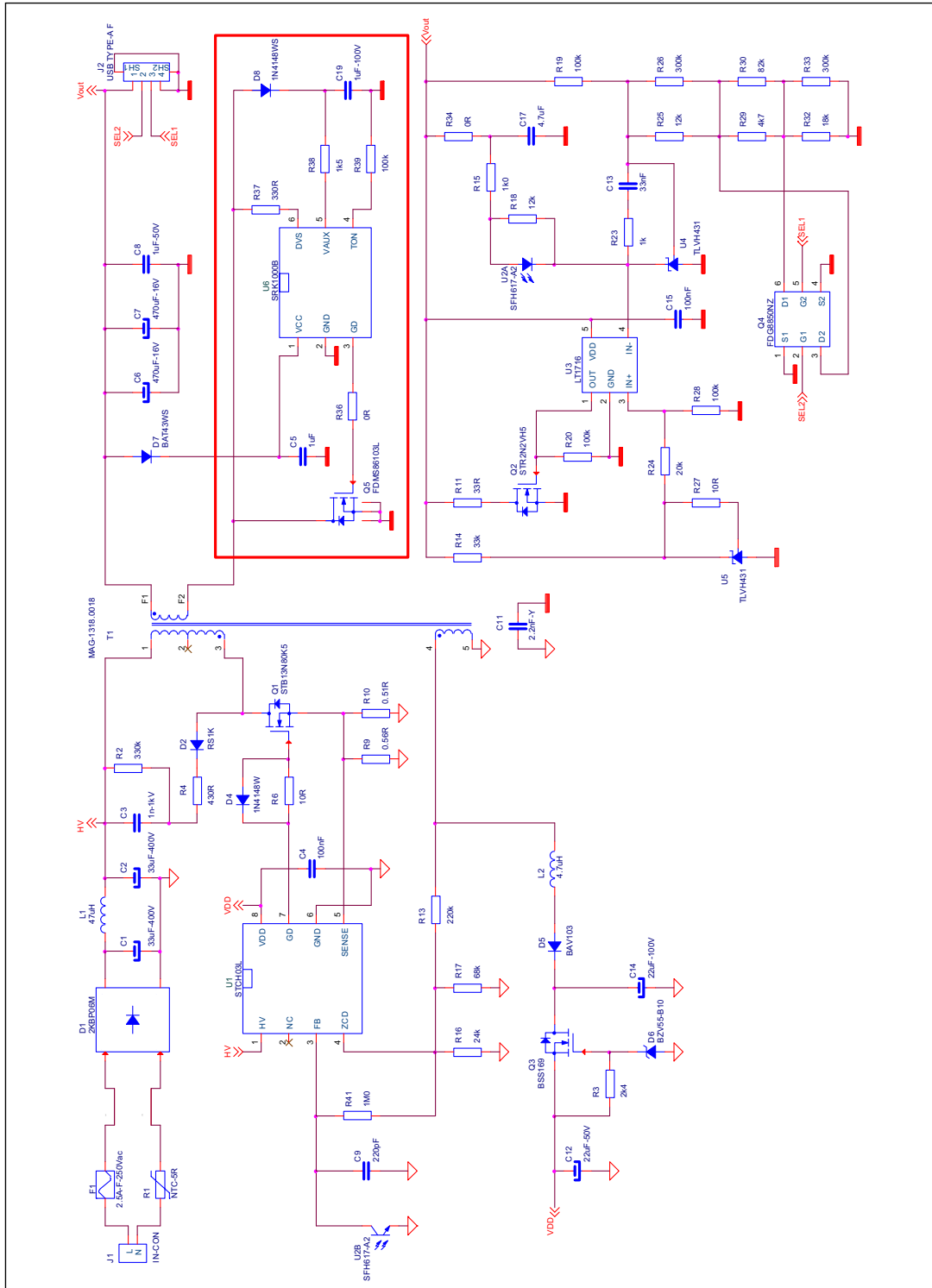

Figure 2. CV-CC regulation @ 12Vout

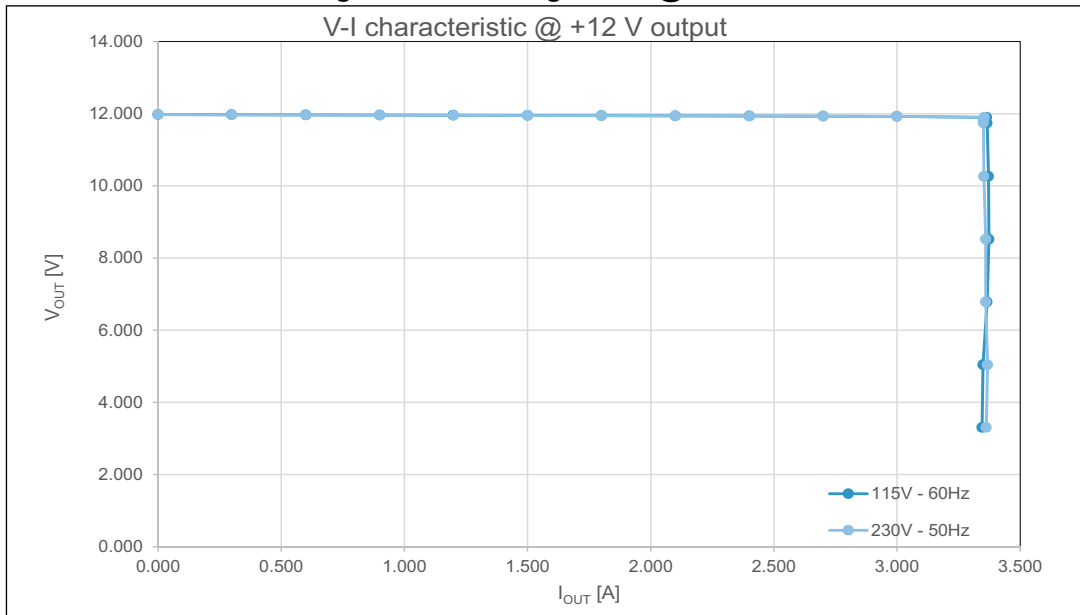

Figure 3. CV-CC regulation @ 9Vout

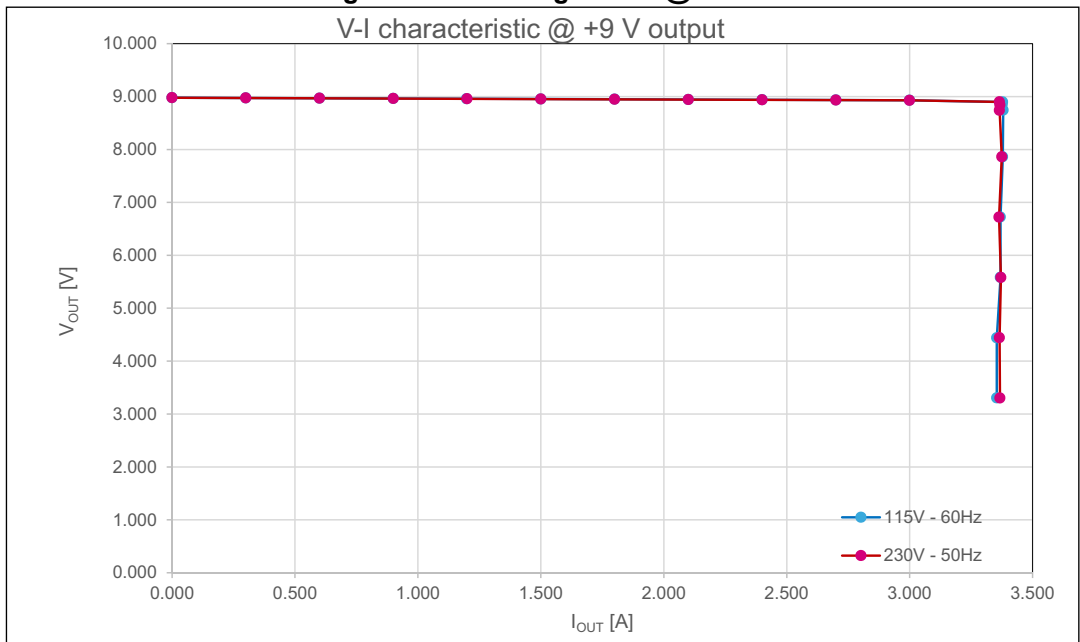

Figure 4. CV-CC regulation @ 5Vout

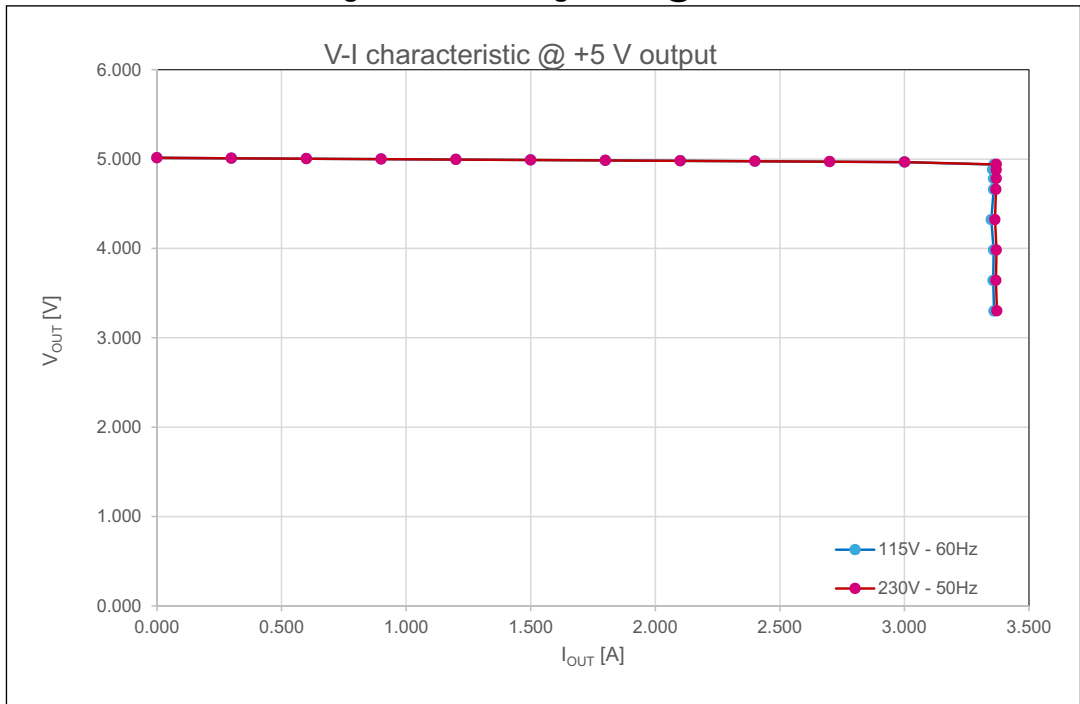

Figure 5. Efficiency plot @ 12 V output

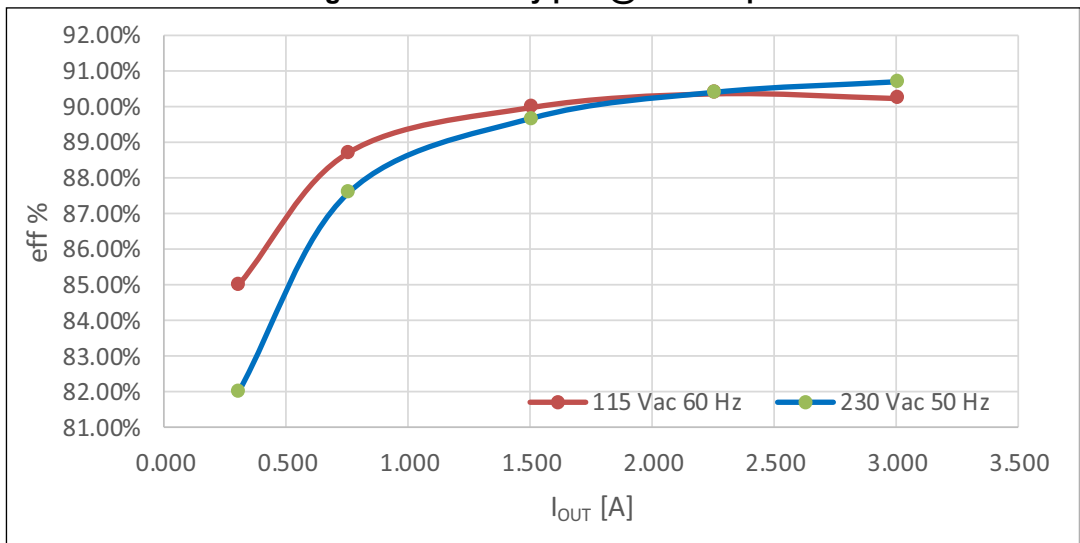

Figure 6. Efficiency plot @ 9 V output

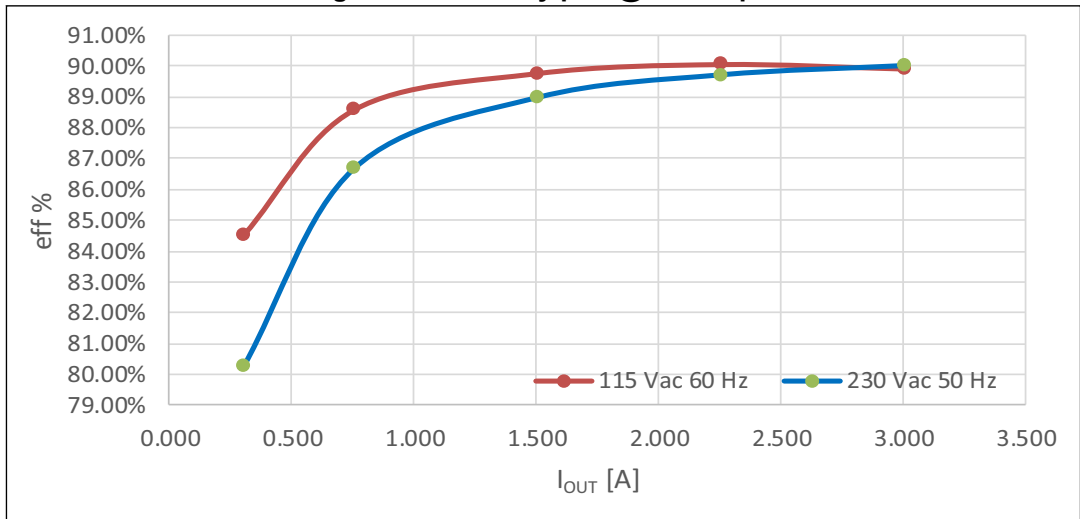
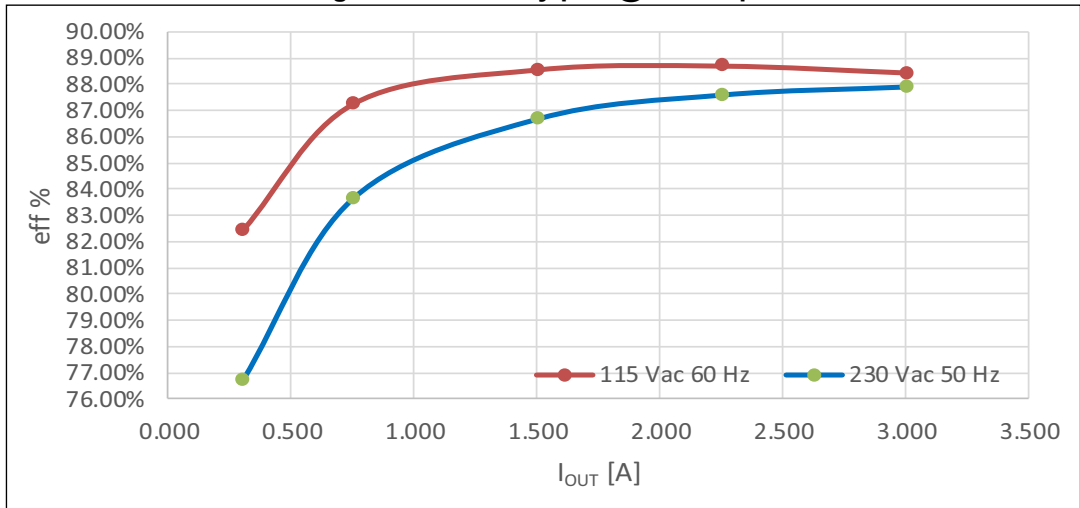

Figure 7. Efficiency plot @ 5 V output



2 Efficiency & no-load consumption data

Table 1. Measurements @ +12 V output

Percent of rated load	Efficiency %	
	115 Vac - 60 Hz	230 Vac - 50 Hz
100%	90.24%	90.68%
75%	90.37%	90.39%
50%	89.99%	89.66%
25%	88.73%	87.58%
avg eff. %	89.83%	89.58%
CoC-2016 - Tier2 requirement:		88.30%
Input voltage	Efficiency % (@10% Load)	
115 Vac - 60 Hz	85.03%	
230 Vac - 50 Hz	82.02%	
CoC-2016 - Tier2 requirement:		78.30%

Table 2. Measurements @ +9 V output

Percent of rated load	Efficiency %	
	115 Vac - 60 Hz	230 Vac - 50 Hz
100%	89.91%	90.01%
75%	90.06%	89.71%
50%	89.77%	88.98%
25%	88.58%	86.67%
avg eff. %	89.58%	88.84%
CoC-2016 - Tier2 requirement:		87.30%
Input voltage	Efficiency % (@10% Load)	
115 Vac - 60 Hz	84.51%	
230 Vac - 50 Hz	80.29%	
CoC-2016 - Tier2 requirement:		77.30%

Table 3. Measurements @ +5 V output

Percent of rated load	Efficiency %	
	115 Vac - 60 Hz	230 Vac - 50 Hz
100%	88.43%	87.88%
75%	88.70%	87.57%
50%	88.55%	86.66%
25%	87.26%	83.66%
avg eff. %	88.24%	86.44%
CoC-2016 - Tier2 requirement:		81.84%
Input voltage	Efficiency % (@10% Load)	
115 Vac - 60 Hz	82.42%	
230 Vac - 50 Hz	76.73%	
CoC-2016 - Tier2 requirement:		72.48%
Input voltage	no-Load consumption	
115 Vac - 60 Hz	16.0mW	
230 Vac - 50 Hz	16.7mW	

3 Revision history

Table 4. Revision history

Date	Revision	Changes
23-Feb-2019	1	Initial release

IMPORTANT NOTICE – PLEASE READ CAREFULLY

STMicroelectronics NV and its subsidiaries ("ST") reserve the right to make changes, corrections, enhancements, modifications, and improvements to ST products and/or to this document at any time without notice. Purchasers should obtain the latest relevant information on ST products before placing orders. ST products are sold pursuant to ST's terms and conditions of sale in place at the time of order acknowledgement.

Purchasers are solely responsible for the choice, selection, and use of ST products and ST assumes no liability for application assistance or the design of Purchasers' products.

No license, express or implied, to any intellectual property right is granted by ST herein.

Resale of ST products with provisions different from the information set forth herein shall void any warranty granted by ST for such product.

ST and the ST logo are trademarks of ST. All other product or service names are the property of their respective owners.

Information in this document supersedes and replaces information previously supplied in any prior versions of this document.

© 2019 STMicroelectronics – All rights reserved