

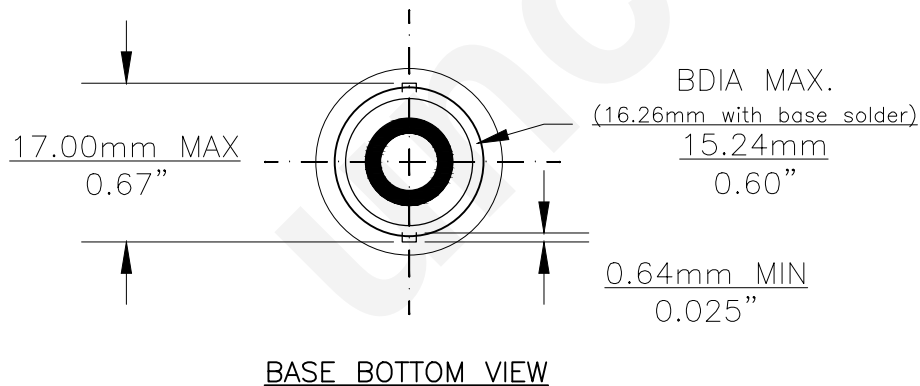

PART NO.	BASE TYPE	DESIGN VOLTS	DESIGN AMPS	MSCD	FILAMENT TYPE	AVERAGE LIFE HOURS	REVISIONS			
							REV #	DESCRIPTION	DATE	APPROVED
5007LL	S.C. BAYONET (BA15s)	12.0V	0.41±10%	4.0±20%	C-2R	400	1	CORRECT THE GDIA MEASUREMENT	03/23/2009	S.L.

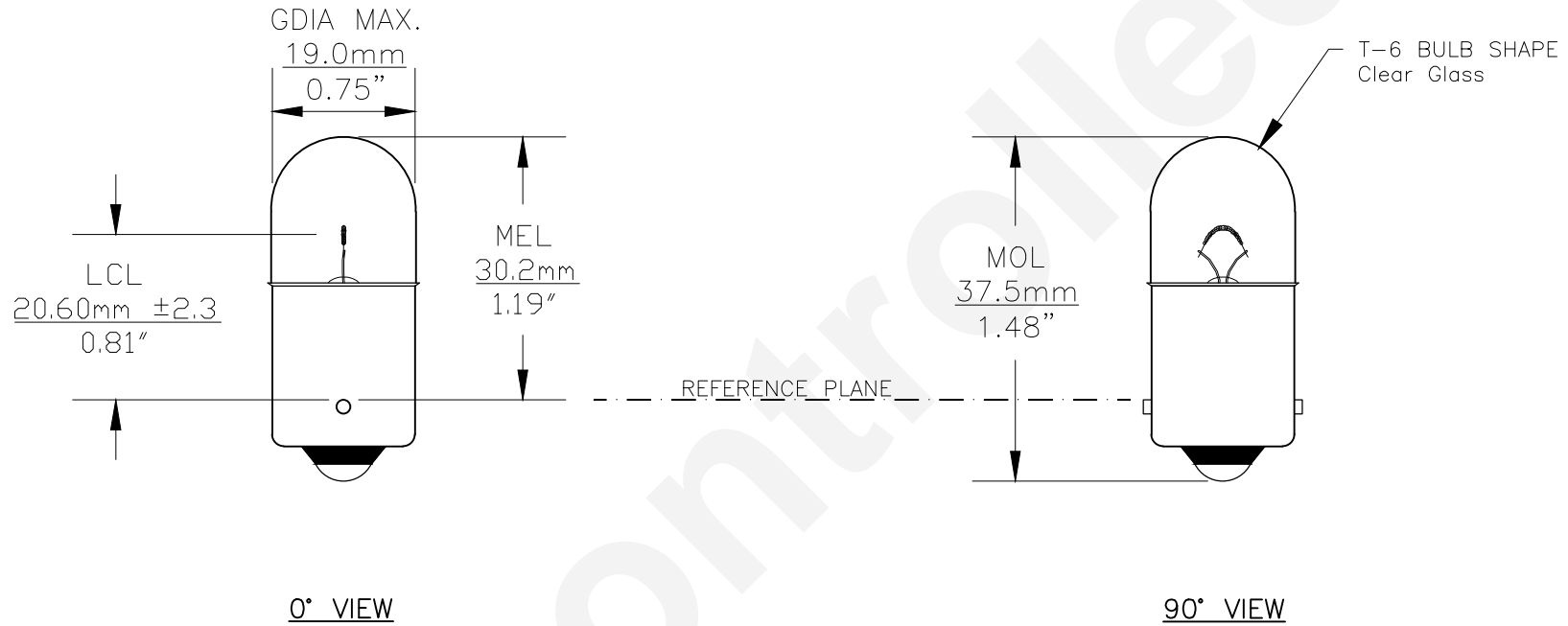

Note: Made according to ECE/R37 specifications

UNLESS OTHERWISE SPECIFIED: DIMENSIONS ARE IN INCHES TOLERANCES		CEC INDUSTRIES LTD			
DECIMALS .XX ± .05	ANGULAR ± 0.5°	599 BOND STREET		LINCOLNSHIRE, IL 60069	
.XXX ± .010	FRACTIONAL ± 1/64	TITLE LIGHT BULB NO. 5007LL			
DRAWN ANNA SOLOVEYCHIK	DATE 03/07/2002	SIZE A	FSCM NO.	DWG NO. 5007LL	REV 1
CHECKED	DESIGN	SCALE	PLOT SCALE	SHEET 1 OF 1	
MATERIAL	FILE 5007LL.pdf	DRAWING NOT TO SCALE			