

## Smart Sensors

Laser Displacement Sensors CMOS Type

ZX2 Series

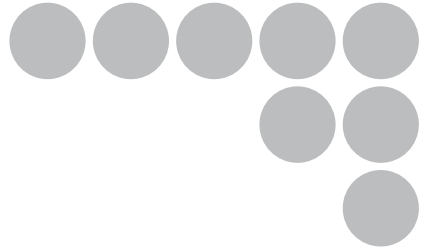

## User's Manual



# CONTENTS

## Introduction

Meanings of Signal Words	8
Meanings of Alert Symbols	8
Laser Safety	9
Precautions for Safe Use	11
Precautions for Correct Use	12
How to Use This Manual	14

## PREPARATION FOR MEASUREMENT

<b>Part Names and Functions</b>	<b>18</b>
Basic Configuration	18
Amplifier Unit	19
Sensor Head	22
Calculating Unit	22
<b>Installation</b>	<b>23</b>
Installing Sensor Heads	23
Installing the Amplifier Unit	24
Connecting Calculating Units	25
Connecting the Sensor Head to the Amplifier Unit	27
<b>Wiring Diagram</b>	<b>28</b>
Wiring Input/Output Cables	28
I/O Circuit Diagrams	31

## FLOW OF OPERATION

FLOW OF OPERATION	34
-------------------	----

## BASIC SETUP

<b>BASIC SETUP</b>	<b>38</b>
Display of RUN Mode	38
Simplest Setting	38

## MAIN APPLICATIONS & SETTING METHODS

Height	40
Steps and Warpage	45

Double Sheet Detection . . . . .	50
Thickness . . . . .	55
Positioning . . . . .	64
Eccentricity and Surface Deflection . . . . .	70

**CONTENTS**

**INTRODUCTION**

**PREPARATION FOR MEASUREMENT**

**FLOW OF OPERATION**

**BASIC SETUP**

**MAIN APPLICATIONS & SETTING METHODS**

**Height**

**Steps and Warpage**

**Double Sheet Detection**

**Thickness**

**Positioning**

**Eccentricity and Surface Deflection**

**DETAILED SETTINGS**

**TROUBLE-SHOOTING**

**SPECIFICATIONS**

**INDEX**

**SETTING TRANSITION CHARTS**

## DETAILED SETTINGS

Smart Tuning . . . . .	78
Connecting Two or More Amplifier Units . . . . .	82
Mutual Interference Prevention . . . . .	84
Setting the Hysteresis . . . . .	87
Setting the Hold Function . . . . .	89
Bank Setting . . . . .	95
Zero Reset . . . . .	97
Scaling . . . . .	101
Analog Output . . . . .	105
Output for Non-measurement . . . . .	107
Timer . . . . .	110
Setting the Differential Function . . . . .	112
External Input for Bank, Timing Input, Reset Input . . . . .	114
Setting the Detection Surface Selection . . . . .	116
Key Lock Function . . . . .	118
Initializing Settings Data . . . . .	119

## TROUBLESHOOTING

Troubleshooting . . . . .	124
Error Messages . . . . .	126
Q&A . . . . .	129

## SPECIFICATIONS

Specifications and Dimensions . . . . .	132
Amplifier Units . . . . .	132
Sensor Heads . . . . .	134
Sensor Head Extension Cables . . . . .	134
Calculating Unit . . . . .	136
Timing Charts . . . . .	137
Engineering Data (Typical) . . . . .	140
Angle Characteristic . . . . .	140
Linearity Characteristic for Different Materials . . . . .	141
Beam Size . . . . .	142

INDEX . . . . .	143
-----------------	-----

Revision History . . . . .	147
----------------------------	-----

SETTING TRANSITION CHARTS . . . . .	148
-------------------------------------	-----

# Introduction

Thank you for purchasing the ZX2 Series Smart Sensor. This manual provides information regarding functions, performance and operating methods that are required for using the sensor.

When using the ZX2 Smart Sensor, make sure to observe the following:

- The ZX2 Smart Sensor must be operated by personnel knowledgeable in electrical engineering.
- To ensure correct use, please read this manual thoroughly to deepen your understanding of the product.
- Please keep this manual in a safe place so that it can be referred to whenever necessary.

CONTENTS

INTRODUCTION

PREPARATION FOR MEASUREMENT

FLOW OF OPERATION

BASIC SETUP

MAIN APPLICATIONS & SETTING METHODS

Height

Steps and Warpage

Double Sheet Detection

Thickness

Positioning

Eccentricity and Surface Deflection

DETAILED SETTINGS

TROUBLE-SHOOTING

SPECIFICATIONS

INDEX

SETTING TRANSITION CHARTS

## **READ AND UNDERSTAND THIS DOCUMENT**

Please read and understand this document before using the products. Please consult your OMRON representative if you have any questions or comments.

## **WARRANTY**

OMRON's exclusive warranty is that the products are free from defects in materials and workmanship for a period of one year (or other period if specified) from date of sale by OMRON.

OMRON MAKES NO WARRANTY OR REPRESENTATION, EXPRESS OR IMPLIED, REGARDING NON-INFRINGEMENT, MERCHANTABILITY, OR FITNESS FOR PARTICULAR PURPOSE OF THE PRODUCTS. ANY BUYER OR USER ACKNOWLEDGES THAT THE BUYER OR USER ALONE HAS DETERMINED THAT THE PRODUCTS WILL SUITABLY MEET THE REQUIREMENTS OF THEIR INTENDED USE. OMRON DISCLAIMS ALL OTHER WARRANTIES, EXPRESS OR IMPLIED.

## **LIMITATIONS OF LIABILITY**

OMRON SHALL NOT BE RESPONSIBLE FOR SPECIAL, INDIRECT, OR CONSEQUENTIAL DAMAGES, LOSS OF PROFITS OR COMMERCIAL LOSS IN ANY WAY CONNECTED WITH THE PRODUCTS, WHETHER SUCH CLAIM IS BASED ON CONTRACT, WARRANTY, NEGLIGENCE, OR STRICT LIABILITY.

In no event shall responsibility of OMRON for any act exceed the individual price of the product on which liability is asserted.

IN NO EVENT SHALL OMRON BE RESPONSIBLE FOR WARRANTY, REPAIR, OR OTHER CLAIMS REGARDING THE PRODUCTS UNLESS OMRON'S ANALYSIS CONFIRMS THAT THE PRODUCTS WERE PROPERLY HANDLED, STORED, INSTALLED, AND MAINTAINED AND NOT SUBJECT TO CONTAMINATION, ABUSE, MISUSE, OR INAPPROPRIATE MODIFICATION OR REPAIR.

## **SUITABILITY FOR USE**

THE PRODUCTS CONTAINED IN THIS DOCUMENT ARE NOT SAFETY RATED. THEY ARE NOT DESIGNED OR RATED FOR ENSURING SAFETY OF PERSONS, AND SHOULD NOT BE RELIED UPON AS A SAFETY COMPONENT OR PROTECTIVE DEVICE FOR SUCH PURPOSES. Please refer to separate catalogs for OMRON's safety rated products.

OMRON shall not be responsible for conformity with any standards, codes, or regulations that apply to the combination of products in the customer's application or use of the product.

CONTENTS

INTRODUCTION

PREPARATION  
FOR  
MEASUREMENT

FLOW OF  
OPERATION

BASIC  
SETUP

MAIN  
APPLICATIONS  
& SETTING  
METHODS

Height

Steps  
and  
Warpage

Double  
Sheet  
Detection

Thickness

Positioning

Eccentricity  
and Surface  
Deflection

DETAILED  
SETTINGS

TROUBLE-  
SHOOTING

SPECIFI-  
CATIONS

INDEX

SETTING  
TRANSITION  
CHARTS

At the customer's request, OMRON will provide applicable third party certification documents identifying ratings and limitations of use that apply to the products. This information by itself is not sufficient for a complete determination of the suitability of the products in combination with the end product, machine, system, or other application or use.

The following are some examples of applications for which particular attention must be given. This is not intended to be an exhaustive list of all possible uses of the products, nor is it intended to imply that the uses listed may be suitable for the products:

Outdoor use, uses involving potential chemical contamination or electrical interference, or conditions or uses not described in this document.

Nuclear energy control systems, combustion systems, railroad systems, aviation systems, medical equipment, amusement machines, vehicles, safety equipment, and installations subject to separate industry or government regulations.

Systems, machines, and equipment that could present a risk to life or property.

Please know and observe all prohibitions of use applicable to the products.

**NEVER USE THE PRODUCTS FOR AN APPLICATION INVOLVING SERIOUS RISK TO LIFE OR PROPERTY WITHOUT ENSURING THAT THE SYSTEM AS A WHOLE HAS BEEN DESIGNED TO ADDRESS THE RISKS, AND THAT THE OMRON PRODUCT IS PROPERLY RATED AND INSTALLED FOR THE INTENDED USE WITHIN THE OVERALL EQUIPMENT OR SYSTEM.**

## **PERFORMANCE DATA**

Performance data given in this document is provided as a guide for the user in determining suitability and does not constitute a warranty. It may represent the result of OMRON's test conditions, and the users must correlate it to actual application requirements. Actual performance is subject to the OMRON Warranty and Limitations of Liability.

## **CHANGE IN SPECIFICATIONS**

Product specifications and accessories may be changed at any time based on improvements and other reasons.

It is our practice to change model numbers when published ratings or features are changed, or when significant construction changes are made. However, some specifications of the product may be changed without any notice. When in doubt, special model numbers may be assigned to fix or establish key specifications for your application on your request. Please consult with your OMRON representative at any time to confirm actual specifications of purchased products.

CONTENTS

INTRODUCTION

PREPARATION  
FOR  
MEASUREMENT

FLOW OF  
OPERATION

BASIC  
SETUP

MAIN  
APPLICATIONS  
& SETTING  
METHODS

Height

Steps  
and  
Warpage

Double  
Sheet  
Detection

Thickness

Positioning

Eccentricity  
and Surface  
Deflection

DETAILED  
SETTINGS

TROUBLE-  
SHOOTING

SPECIFI-  
CATIONS

INDEX

SETTING  
TRANSITION  
CHARTS

## **DIMENSIONS AND WEIGHTS**

Dimensions and weights are nominal and are not to be used for manufacturing purposes, even when tolerances are shown.

## **ERRORS AND OMISSIONS**

The information in this document has been carefully checked and is believed to be accurate; however, no responsibility is assumed for clerical, typographical, or proofreading errors, or omissions.

## **PROGRAMMABLE PRODUCTS**

OMRON shall not be responsible for the user's programming of a programmable product, or any consequence thereof.

## **COPYRIGHT AND COPY PERMISSION**

This document shall not be copied for sales or promotions without permission.

This document is protected by copyright and is intended solely for use in conjunction with the product. Please notify us before copying or reproducing this document in any manner, for any other purpose. If copying or transmitting this document to another, please copy or transmit it in its entirety.

CONTENTS

INTRODUCTION

PREPARATION  
FOR  
MEASUREMENT

FLOW OF  
OPERATION

BASIC  
SETUP

MAIN  
APPLICATIONS  
& SETTING  
METHODS

Height

Steps  
and  
Warpage

Double  
Sheet  
Detection

Thickness

Positioning

Eccentricity  
and Surface  
Deflection

DETAILED  
SETTINGS

TROUBLE-  
SHOOTING

SPECIFI-  
CATIONS

INDEX

SETTING  
TRANSITION  
CHARTS

## Meanings of Signal Words

The following signal words are used in this manual.



Indicates a potentially hazardous situation which, if not avoided, will result in minor or moderate injury, or may result in serious injury or death. Additionally there may be significant property damage.

## Meanings of Alert Symbols

The following alert symbols are used in this manual.



Indicates the possibility of laser radiation.



Indicates prohibition when there is a risk of minor injury from electrical shock or other source if the product is disassembled.



# Laser Safety

## ■ ZX2-LD□□□ Sensor Head

### WARNING

Never look into the laser beam.  
Doing so continuously will result in visual impairment.



Do not disassemble the product.  
Doing so may cause the laser beam to leak, resulting in the danger of visual impairment.



CONTENTS

INTRODUCTION

PREPARATION  
FOR  
MEASUREMENT

FLOW OF  
OPERATION

BASIC  
SETUP

MAIN  
APPLICATIONS  
& SETTING  
METHODS

Height

Steps  
and  
Warpage

Double  
Sheet  
Detection

Thickness

Positioning

Eccentricity  
and Surface  
Deflection

DETAILED  
SETTINGS

TROUBLE-  
SHOOTING

SPECIFI-  
CATIONS

INDEX

SETTING  
TRANSITION  
CHARTS

The ZX2-LD□□□ Sensor Head is a Class 2 Laser Product according to EN 60825-1 (IEC 60825-1) and Class II Laser Product according to FDA (21 CFR1040.10) (see note). The ZX2 Series is meant to be built into final system equipment. Pay special attention to the following precautions for the safe use of the product:

Note: Europe: Class 1 and Class 2 of EN 60825-1: 1994 +A11:1996 +A2:2001  
= IEC 60825-1:1993 +A1:1997 +A2:2001  
U.S.A.: Class I and Class II of FDA (21 CFR1040.10)

- (1) ZX2-LD□□□ emits visual laser beam. Do not stare directly into the laser.  
Make sure that the laser beam path is terminated. If specular objects are present in the laser beam path, make sure that they are prevented from reflecting the laser beam.  
When used without an enclosure, make sure the laser path from eye level is avoided.
- (2) To avoid exposure to hazardous laser radiation, do not displace nor remove the protective housing during operation, maintenance, and any other servicing.
- (3) As for countries other than those of Europe and the U.S.A., observe the regulations and standards specified by each country.
- (4) Label Indications  
The EN and FDA labels are supplied with the product.  
Replace the current labels with them according to the instructions given in the manuals.

- CONTENTS
- INTRODUCTION
- PREPARATION FOR MEASUREMENT
- FLOW OF OPERATION
- BASIC SETUP
- MAIN APPLICATIONS & SETTING METHODS
- Height
- Steps and Warpage
- Double Sheet Detection
- Thickness
- Positioning
- Eccentricity and Surface Deflection
- DETAILED SETTINGS
- TROUBLE-SHOOTING
- SPECIFICATIONS
- INDEX
- SETTING TRANSITION CHARTS

# Precautions for Safe Use

Please observe the following precautions for safe use of the products.

## ■ Installation Environment

- Do not use the product in environments where it can be exposed to inflammable/explosive gas.
- Do not install the product close to high-voltage devices and power devices in order to secure the safety of operation and maintenance.

## ■ Power Supply and Wiring

- The supply voltage must be within the rated range (DC12 to 24 V $\pm$ 10%).
- Reverse connection of power supply is not allowed. Connection to AC power supply is also not allowed.
- Open-collector outputs should not be short-circuited.
- High-voltage lines and power lines must be wired separately from this product. Wiring them together or placing in the same duct may cause induction, resulting in malfunction or damage.
- Always turn off the power supply before connecting or disconnecting cables and connectors.

## ■ Others

- Do not attempt to dismantle, repair, or modify the product.
- Dispose of this product as industrial waste.

CONTENTS

INTRODUCTION

PREPARATION  
FOR  
MEASUREMENT

FLOW OF  
OPERATION

BASIC  
SETUP

MAIN  
APPLICATIONS  
& SETTING  
METHODS

Height

Steps  
and  
Warpage

Double  
Sheet  
Detection

Thickness

Positioning

Eccentricity  
and Surface  
Deflection

DETAILED  
SETTINGS

TROUBLE-  
SHOOTING

SPECIFI-  
CATIONS

INDEX

SETTING  
TRANSITION  
CHARTS

## Precautions for Correct Use

Please observe the following precautions to prevent failure to operate, malfunctions, or undesirable effects on product performance.

### Installation of the Product

#### ■ Installation Site

Do not install the product in locations subjected to the following conditions:

- Ambient temperature outside the rating
- Rapid temperature fluctuations (causing condensation)
- Relative humidity outside the range of 35 to 85%
- Presence of corrosive or flammable gases
- Presence of dust, salt, or iron particles
- Direct vibration or shock
- Reflective sensor of intense light (such as other laser beams or electric arc-welding machines)
- Direct sunlight or near heaters
- Water, oil, or chemical fumes or spray
- Strong magnetic or electric field

### Component Installation and Handling

#### ■ Power Supply and Wiring

- To extend the output cables of amplifier units, shielded cables of the same specifications as the output cables must be used.
- When using a commercially available switching regulator, make sure that the FG terminal is grounded.
- If surge currents are present in the power lines, connect surge absorbers that suit the operating environment.
- When connecting two or more amplifier units by using calculating units, make sure that the linear GND lines of the amplifier units are connected to each other. Supply power to all connected amplifier units at the same time.
- Before turning ON the power after the product is connected, make sure that the power supply voltage is correct, there are no incorrect connections (e.g. load short-circuit) and the load current is appropriate. Incorrect wiring may result in breakdown of the product.
- The cables must be 10 m or shorter in total length, for both sensor head and amplifier units. To extend the cable from the sensor head, an optional extension cable (ZX2-XC□R) must be used. For extension of the cable of amplifier units, shielded cables of the same type must be used.
- When using calculating units, make sure that the linear GND lines of the amplifier units are connected to each other.

CONTENTS

INTRODUCTION

PREPARATION  
FOR  
MEASUREMENT

FLOW OF  
OPERATION

BASIC  
SETUP

MAIN  
APPLICATIONS  
& SETTING  
METHODS

Height

Steps  
and  
Warpage

Double  
Sheet  
Detection

Thickness

Positioning

Eccentricity  
and Surface  
Deflection

DETAILED  
SETTINGS

TROUBLE-  
SHOOTING

SPECIFI-  
CATIONS

INDEX

SETTING  
TRANSITION  
CHARTS

## ■ Warming Up

After turning ON the power supply, allow the product to stand for at least 10 minutes before use. The circuits are still unstable just after the power supply is turned ON, so measured values may fluctuate gradually.

## ■ Sensing Object

The product cannot accurately measure the following types of objects: Transparent objects, objects with an extremely low reflective sensor ratio, objects smaller than the beam size, objects with a large curvature, excessively inclined objects, etc.

## ■ Mutual Interference

Inserting a calculating unit between amplifier units can prevent mutual interference between two sensor heads. However, this may not work efficiently if one sensor head is saturated and a laser beam of the other sensor head is input. If you are interested in installing a calculating unit in order to prevent mutual interference, carry out a test using the actual system beforehand.

## ■ Maintenance

- Always turn OFF the power supply before adjusting or connecting/disconnecting the sensor head.
- Do not use thinner, benzene, acetone or kerosene to clean the sensor head and amplifier units. If large dust particles adhere to the front filter of the sensor head, use a blower brush (used to clean camera lenses) to blow them off. Do not blow the dust away with your mouth. To remove smaller dust particles, use a soft cloth (for lenses) with a small amount of alcohol. Take care not to wipe them off with excessive force.

Scratches on the filter may cause errors.

# How to Use This Manual

## Page Format

This section explains the page format by using the Setting for MAIN APPLICATIONS AND SETTING METHODS chapter as an example.

### Index label

Shows the chapter and header titles with white characters.

**Height**

CONTENTS

INTRODUCTION

PREPARATION FOR MEASUREMENT

FLOW OF OPERATION

BASIC SETUP

MAIN APPLICATIONS & SETTING METHODS

Height

Steps and Warpage

Double Sheet Detection

Thickness

Positioning

Thickness

Eccentricity and Surface Deflection

Positioning

Eccentricity and Surface Deflection

DETAILED SETTINGS

TROUBLE-SHOOTING

SPECIFICATIONS

INDEX

SETTING TRANSITION CHARTS

40 Height

ZX2 User's Manual

### Header

Indicates the measurement contents.

### Flow

Shows the flow of operation.

### Operation procedure

Explains the operation procedure.

### Explanation of Selection Menu

Provides a supplemental explanation of the selection menu.

### Description of Operation

Explains how to perform the operation by using buttons.







### Display

Shows what is displayed as a result of the operation.

### Button Operation

Shows how to use the buttons.

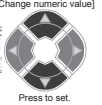
# Meanings of Symbols

Symbol	Meaning
<b>Important</b>	Indicates points that are important to achieve the full product performance, such as operational precautions and application procedures.
<b>(For details about xxx, see page xx.)</b>	Indicates pages where related information can be found.
<b>Required</b> (white characters on a black background)	Indicates a required setting in a setup procedure.
<b>Optional</b> (black characters on a white background)	Indicates an optional setting in a setup procedure.
 	Indicates which button to press to display the menu shown in the Display column.
 	Indicates that the user can select the menu that accords with their usage conditions by pressing the relevant button.
<p>[Change numeric value]</p>  	Indicates that the user can specify a value that accords with their usage conditions by pressing the relevant button.

CONTENTS

INTRODUCTION

PREPARATION FOR MEASUREMENT

FLOW OF OPERATION

BASIC SETUP

MAIN APPLICATIONS & SETTING METHODS

Height

Steps and Warpage

Double Sheet Detection

Thickness

Positioning

Eccentricity and Surface Deflection

DETAILED SETTINGS

TROUBLE-SHOOTING

SPECIFICATIONS

INDEX

SETTING TRANSITION CHARTS

CONTENTS

INTRODUCTION

PREPARATION  
FOR  
MEASUREMENT

FLOW OF  
OPERATION

BASIC  
SETUP

MAIN  
APPLICATIONS  
& SETTING  
METHODS

Height

Steps  
and  
Warpage

Double  
Sheet  
Detection

Thickness

Positioning

Eccentricity  
and Surface  
Deflection

DETAILED  
SETTINGS

TROUBLE-  
SHOOTING

SPECIFI-  
CATIONS

INDEX

SETTING  
TRANSITION  
CHARTS



# PREPARATION FOR MEASUREMENT

---

<b>Part Names and Functions</b>	<b>18</b>
<b>Installation</b>	<b>23</b>
<b>Wiring Diagram</b>	<b>28</b>

# Part Names and Functions

## Basic Configuration

The basic configuration of the ZX2 series Smart Sensors is shown below.

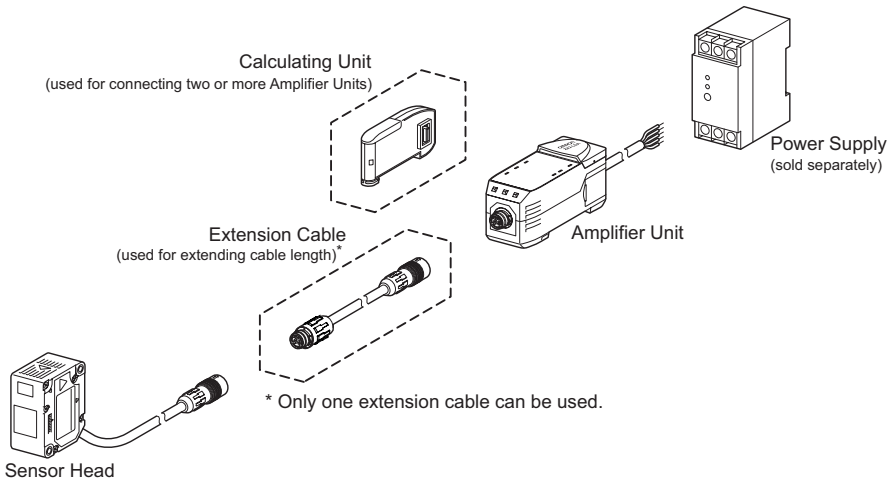

See the following pages for details:

	Part Names and Functions	Specifications and Dimensions
Sensor Heads	p. 22	p. 134
Amplifier Units	p. 19	p. 132
Calculating Unit	p. 22	p. 136
Extension Cables	—	p. 134

# Amplifier Unit

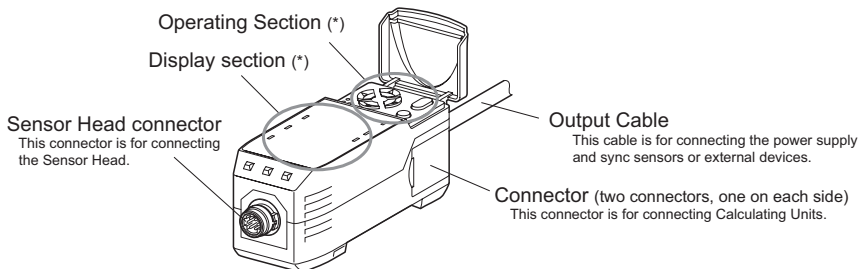

## (\*) Operating and Display Sections

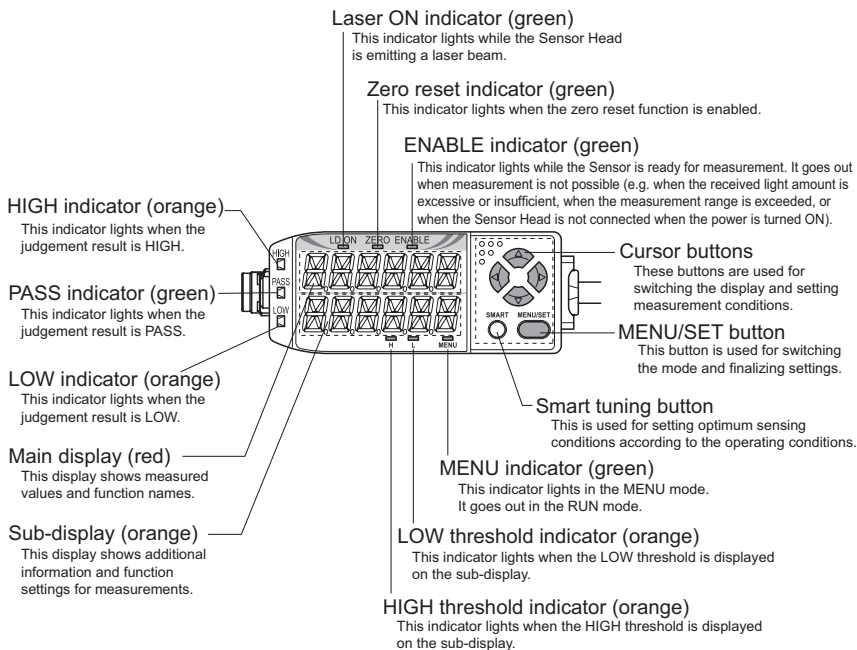

CONTENTS

INTRODUCTION

PREPARATION FOR MEASUREMENT

FLOW OF OPERATION

BASIC SETUP

MAIN APPLICATIONS & SETTING METHODS

Height

Steps and Warpage

Double Sheet Detection

Thickness

Positioning

Eccentricity and Surface Deflection

DETAILED SETTINGS

TROUBLE-SHOOTING

SPECIFICATIONS

INDEX



SETTING TRANSITION CHARTS

# Digital Displays

The information displayed on the main and sub-displays depends on the currently selected mode. The default mode is the RUN mode.

When the power is turned ON, the model of Amplifier Unit (ZX2-LDA) will be displayed on the main display and the channel number will be displayed on the sub-display. Subsequently, the Sensor Head software version will be displayed on the main display and the Amplifier Unit software version will be displayed on the sub-display.

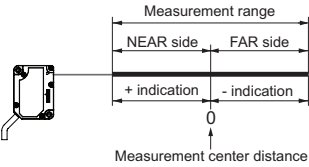
These details are displayed for approximately five seconds, and then data for the RUN mode will be displayed.

Mode	Main display (upper section, red)	Sub-display (lower section, orange)
RUN	<p>The measured value (the value after the measurement conditions have been reflected) is displayed.</p> <p>For example, when the hold function is set, the held value will be displayed.</p> <p>Default measured values are as follows:</p>  <p>The diagram shows a side view of a sensor head. A horizontal line represents the measurement range, divided into 'NEAR side' and 'FAR side'. Below this, a smaller horizontal line represents the measurement center distance, with a central point labeled '0'. Arrows indicate the '+ indication' on the left and '- indication' on the right.</p>	<p>By pressing the  button, the HIGH threshold, LOW threshold, analog output value, resolution (max. value of measured value during one second - min. value), current value (value before execution of zero reset, hold, scaling and 2-sensor operation), and BANK are displayed in this order.</p>
MENU	<p>The function names are displayed in order by pressing the  buttons.</p>	<p>The setting for the function displayed on the main display is displayed.</p>

(For details on setting transition charts, see page 148.)









## Alphabet Display Format

The alphabet appears on the main and sub-displays as shown in the following table.

A	B	C	D	E	F	G	H	I	J	K	L	M
<i>A</i>	<i>B</i>	<i>C</i>	<i>d</i>	<i>E</i>	<i>F</i>	<i>G</i>	<i>H</i>	<i>I</i>	<i>J</i>	<i>K</i>	<i>L</i>	<i>M</i>
N	O	P	Q	R	S	T	U	V	W	X	Y	Z
<i>N</i>	<i>O</i>	<i>P</i>	<i>Q</i>	<i>R</i>	<i>S</i>	<i>T</i>	<i>U</i>	<i>V</i>	<i>W</i>	<i>X</i>	<i>Y</i>	<i>Z</i>

# Button Operation

The functions of buttons change according to the currently selected mode.

Button type		Button function	
		RUN mode	MENU mode
Cursor buttons	 button  button	<ul style="list-style-type: none"> <li>Normal press: Changes the sub-display content.*</li> <li>Both  buttons held down for three seconds: Locks button operation.</li> </ul>	Function changes depending on the setting. <ul style="list-style-type: none"> <li>Switches the function display.</li> <li>Selects the digit of numerical values.</li> <li>Stops setting.</li> </ul>
	 button	<ul style="list-style-type: none"> <li>Normal press: Executes timing input.</li> </ul>	The function changes depending on the setting. <ul style="list-style-type: none"> <li>Changes the selection menu.</li> <li>Changes numerical values.</li> </ul>
	 button	<ul style="list-style-type: none"> <li>Held down for one second: Executes zero reset.</li> <li>Both  buttons held down for one second: Cancels a zero reset.</li> </ul>	
	MENU/SET button 	<ul style="list-style-type: none"> <li>Held down for 3 seconds: Changes the mode to the MENU mode.</li> </ul>	<ul style="list-style-type: none"> <li>Normal press: Finalizes the set condition or value.</li> <li>Held down for 3 seconds: Changes to the RUN mode.</li> </ul>
Smart tuning button 	<ul style="list-style-type: none"> <li>Held down for one second, held down for three seconds, held down for five seconds: Executes smart tuning according to the time the button is held down.</li> </ul>	<ul style="list-style-type: none"> <li>Held down for one second, held down for three seconds, held down for five seconds: Executes smart tuning according to the time the button is held down.</li> </ul>	

\* Do not move the workpiece while a button is being pressed.  
The output is not updated while the sub-display is being switched.

CONTENTS

INTRODUCTION

PREPARATION FOR MEASUREMENT

FLOW OF OPERATION

BASIC SETUP

MAIN APPLICATIONS & SETTING METHODS

Height

Steps and Warpage

Double Sheet Detection

Thickness

Positioning

Eccentricity and Surface Deflection

DETAILED SETTINGS

TROUBLE-SHOOTING

SPECIFICATIONS

INDEX

SETTING TRANSITION CHARTS

# Sensor Head

- CONTENTS
- INTRODUCTION
- PREPARATION FOR MEASUREMENT
- FLOW OF OPERATION
- BASIC SETUP
- MAIN APPLICATIONS & SETTING METHODS
- Height
- Steps and Warpage
- Double Sheet Detection
- Thickness
- Positioning
- Eccentricity and Surface Deflection
- DETAILED SETTINGS
- TROUBLE-SHOOTING
- SPECIFICATIONS
- INDEX
- SETTING TRANSITION CHARTS

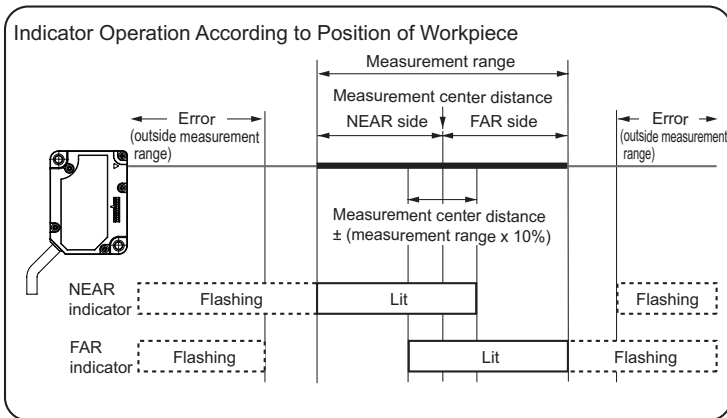
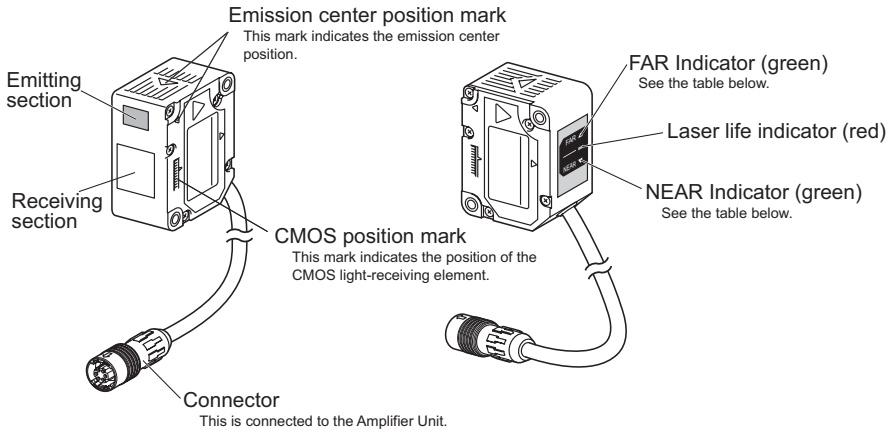

## Calculating Unit (used for connecting two or more Amplifier Units)

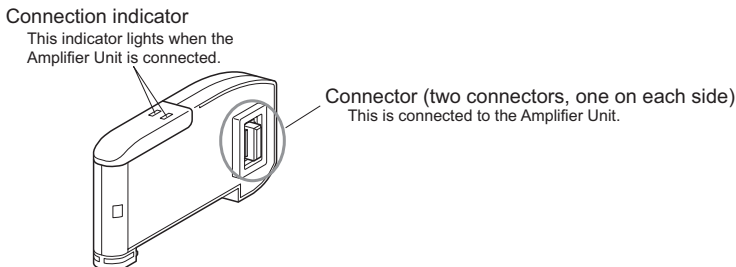

# Installation

## Important

Before connecting/disconnecting Smart Sensor components, make sure that the power to the Amplifier Unit is turned OFF. The Smart Sensor may malfunction if components are connected or removed while the power is ON.

## Installing Sensor Heads

### Installation Method

- Check the Sensor Head setting position by its emission center mark.
- Fix the sensor head in place with M3 screws. The screws must be tightened with a torque of 0.5 N·m.

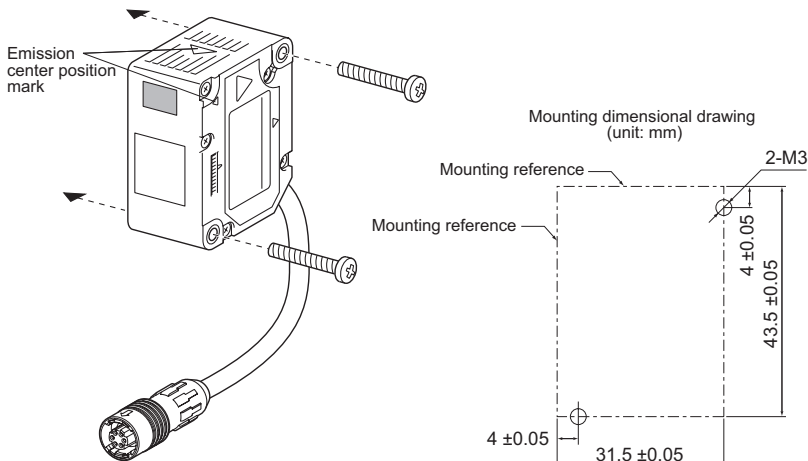

- Be sure to attach the ferrite core accessory on the Sensor Head. Attach it within 100 mm of the Sensor Head side.

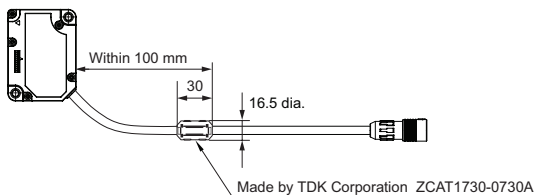

## Important

- When mounting a Sensor Head, take care not to touch the emitter and receiver. Finger marks on the emitter and receiver may hinder correct measurements. If you have touched them by mistake, wipe them with a clean, soft cloth.
- Fix the connectors in places that are not subject to vibration or impact.

CONTENTS

INTRODUCTION

PREPARATION  
FOR  
MEASUREMENT

FLOW OF  
OPERATION

BASIC  
SETUP

MAIN  
APPLICATIONS  
& SETTING  
METHODS

Height

Steps  
and  
Warpage

Double  
Sheet  
Detection

Thickness

Positioning

Eccentricity  
and Surface  
Deflection

DETAILED  
SETTINGS

TROUBLE-  
SHOOTING

SPECIFI-  
CATIONS

INDEX

SETTING  
TRANSITION  
CHARTS

# Installing the Amplifier Unit

Amplifier Units can be easily mounted to 35-mm DIN Track.

## Installation Method

Hook the connector end of the Sensor Head on the DIN Track, and press in at the bottom until the Amplifier Unit locks into place. If necessary, fix it in place by the End Plate.

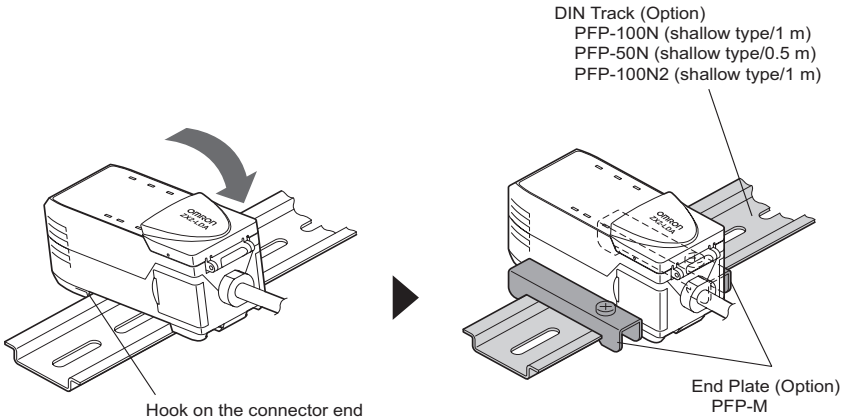

### Important

Hook the connector end of the Sensor Head on the DIN Track first. The mounting strength may decrease if the output cable end is hooked on the DIN Track first.

## Removal Method

Push the Amplifier Unit and pull out from the connector end of the Sensor Head.

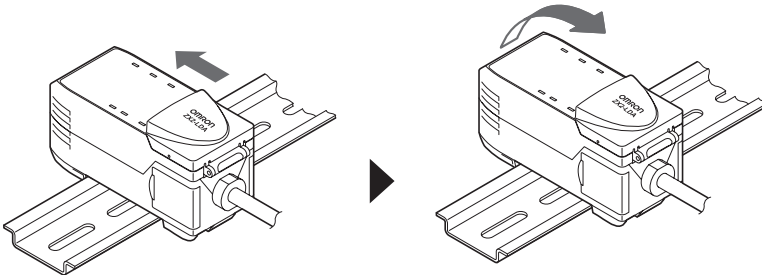



# Connecting Calculating Units

Use a Calculating Unit to connect Amplifier Units when performing calculations between Amplifier Units and to prevent mutual interference between Sensor Heads.

The number of Amplifier Units that can be connected differs depending on the functions to be used.

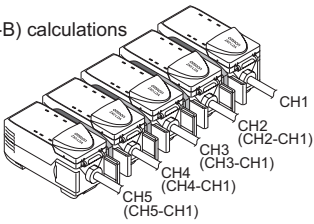
Function	Number of Connectable Amplifier Units	See:
Calculation	Up to two units (Up to five units can be connected. However, calculations are done between pairs of two.)  For (A-B) calculations  	(A-B) calculation: Page 45 Thickness calculation: Page 55
Mutual interference prevention	Up to five units	Page 84

For details on the connection method, see the next page.

CONTENTS

INTRODUCTION

PREPARATION FOR MEASUREMENT

FLOW OF OPERATION

BASIC SETUP

MAIN APPLICATIONS & SETTING METHODS

Height

Steps and Warpage

Double Sheet Detection

Thickness

Positioning

Eccentricity and Surface Deflection

DETAILED SETTINGS

TROUBLE-SHOOTING

SPECIFICATIONS

INDEX

SETTING TRANSITION CHARTS

# Connection Method

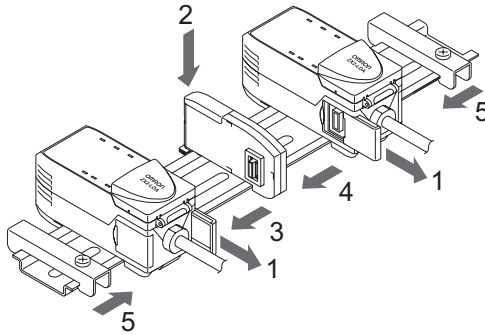

- 1 Open the connector cover on the Amplifier Unit.**  
Open the connector cover by lifting and sliding it.
- 2 Mount the Calculating Unit to the DIN Track.**
- 3 Slide and connect the Calculating Unit to the Amplifier Unit connector.**
- 4 Slide and connect the second Amplifier Unit to the Calculating Unit connector.**
- 5 Fix in place with the End Plate (sold separately: PFP-M).**

## Important

- To disconnect Amplifier Units and Calculating Units, perform the above operations in reverse order.
- The following diagram shows the channel numbers when multiple Amplifier Units are connected.

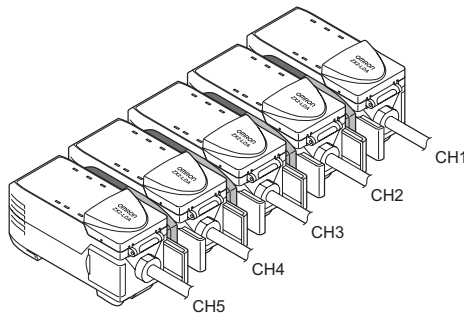

# Connecting the Sensor Head to the Amplifier Unit

## Installation Method

Align the position of the connector ⇨ mark with the ▲ mark on the Amplifier Unit, and insert the connector until it is locked in place.

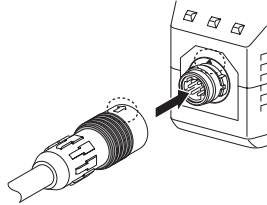

### Important

- Extending the Sensor Head cable  
An optional extension cable (ZX2-XC□R) must be used.  
Only one extension cable can be used.  
Be sure to attach the two supplied ferrite cores within 100 mm of each end of the extension cable.

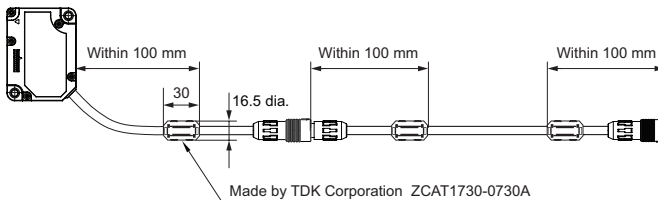

## Removal Method

To disconnect the Sensor Head, hold the Sensor Head's connector ring and the Amplifier Unit connector, and then pull them straight out.

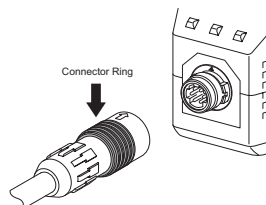

### Important

- Do not touch the terminals inside the connector.
- Prevent the connector from being subjected to static electricity.
- When the Sensor Head is replaced with a different type, set all the setting data inside the Amplifier Unit again since it will be cleared. (**default values:** → See page 119.)

CONTENTS

INTRODUCTION

PREPARATION  
FOR  
MEASUREMENT

FLOW OF  
OPERATION

BASIC  
SETUP

MAIN  
APPLICATIONS  
& SETTING  
METHODS

Height

Steps  
and  
Warpage

Double  
Sheet  
Detection

Thickness

Positioning

Eccentricity  
and Surface  
Deflection

DETAILED  
SETTINGS

TROUBLE-  
SHOOTING

SPECIFI-  
CATIONS

INDEX

SETTING  
TRANSITION  
CHARTS

# Wiring Diagram

## Wiring Input/Output Cables

The input/output cable has the following wires.

### Important

Wire the cable correctly. Incorrect wiring may damage the Smart Sensor.

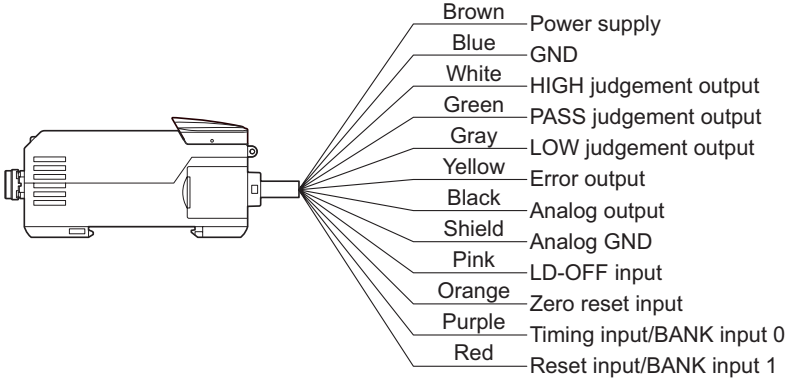

Cable color	Name	Function
Brown	Power supply	Connects the 10 to 30 VDC (including (p-p) 10% ripple) power supply. When using an Amplifier Unit with a PNP output, the power supply terminal is also the common I/O terminal for all I/O except for the analog output.
Blue	GND (0 V)	The GND terminal is the 0 V power supply terminal. When using an Amplifier Unit with an NPN output, the power supply terminal is also the common I/O terminal for all I/O except for the analog output.
White	HIGH judgement output	The HIGH judgement output outputs judgement results (HIGH).
Green	PASS judgment output	The PASS judgement output outputs judgement results (PASS).
Gray	LOW judgment output	The LOW judgement output outputs judgement results (LOW).
Yellow	Error output	This is output when the system detects an error. <b>(For details on error messages, see page 126.)</b>

Cable color	Name	Function
Black	Analog output	The analog output outputs a current or voltage in accordance with the measured value. <b>(For details on setting method, see page 105.)</b>
Shield	Analog GND (0 V)	The analog GND terminal is the 0 V terminal for the analog output.  <b>Important</b> <ul style="list-style-type: none"> <li>• Use the shield for analog output separately from the blue (0V) wire for power supply.</li> <li>• When analog output is not used, be sure to connect this wire to the blue (0 V) wire.</li> <li>• When using Calculating Units, make sure that the analog GND lines of the Amplifier Units are connected to each other.</li> </ul>
Pink	LD-OFF input	If this LD-OFF input signal is ON, the laser will stop emission, causing a light intensity error. In this case, the analog output, digital display, judgement output, and judgement output display signals will be output according to the non-measurement settings. The sub-display will show <i>LdOFF</i> .
Orange	Zero reset input	The zero reset input is used to execute and cancel zero reset. <b>(For details, see page 97.)</b>
Purple	Timing input/ BANK input 0 (switched by external input setting)	Timing input: Signal input wire for obtaining hold function timing. While this input is being input, the sub-display will show <i>ETIMING</i> . BANK input 0: Signal input wire for bank switching. Banks are switched by ON/OFF combinations with BANK input 1. When connecting two or more Amplifier Units, use the CH1 Amplifier Unit for bank switching. The banks of the Amplifier Units of CH2 and later are switched together with CH1. <b>(For details on switching and inputs, see page 114.)</b>

CONTENTS

INTRODUCTION

PREPARATION  
FOR  
MEASUREMENTFLOW OF  
OPERATIONBASIC  
SETUPMAIN  
APPLICATIONS  
& SETTING  
METHODS

Height

Steps  
and  
WarpageDouble  
Sheet  
Detection

Thickness

Positioning

Eccentricity  
and Surface  
DeflectionDETAILED  
SETTINGSTROUBLE-  
SHOOTINGSPECIFI-  
CATIONS

INDEX

SETTING  
TRANSITION  
CHARTS

Cable color	Name	Function
Red	Reset input/BANK input 1 (switched by external input setting)	<p>Reset input:</p> <p>The reset input resets all measurement processing and outputs. While reset input is being input, the sub-display will show <i>RESET</i>. The analog and judgement output signals will be output according to the non-measurement settings. If this reset input switches ON while the hold function is used, the state in effect before the hold function was set will be restored.</p> <p>BANK input 1:</p> <p>Signal input wire for bank switching. Banks are switched by ON/OFF combinations with BANK input 0.</p> <p>When connecting two or more Amplifier Units, use the CH1 Amplifier Unit for bank switching. The banks of the Amplifier Units of CH2 and later are switched together with CH1.</p> <p><b>(For details on switching and inputs, see page 114.)</b></p>

CONTENTS

INTRODUCTION

PREPARATION  
FOR  
MEASUREMENTFLOW OF  
OPERATIONBASIC  
SETUPMAIN  
APPLICATIONS  
& SETTING  
METHODS

Height

Steps  
and  
WarpageDouble  
Sheet  
Detection

Thickness

Positioning

Eccentricity  
and Surface  
DeflectionDETAILED  
SETTINGSTROUBLE-  
SHOOTINGSPECIFI-  
CATIONS

INDEX

SETTING  
TRANSITION  
CHARTS

# I/O Circuit Diagrams

## NPN Amplifier Unit

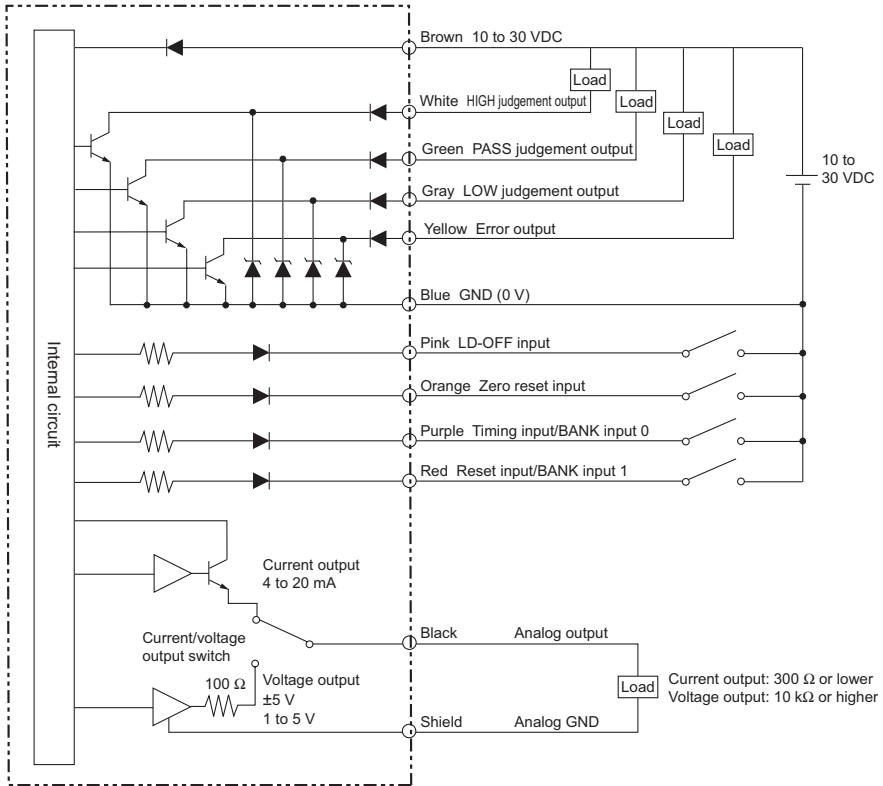

CONTENTS

INTRODUCTION

PREPARATION FOR MEASUREMENT

FLOW OF OPERATION

BASIC SETUP

MAIN APPLICATIONS & SETTING METHODS

Height

Steps and Warpage

Double Sheet Detection

Thickness

Positioning

Eccentricity and Surface Deflection

DETAILED SETTINGS

TROUBLE-SHOOTING

SPECIFICATIONS

INDEX

SETTING TRANSITION CHARTS

- CONTENTS
- INTRODUCTION
- PREPARATION FOR MEASUREMENT
- FLOW OF OPERATION
- BASIC SETUP
- MAIN APPLICATIONS & SETTING METHODS
- Height
- Steps and Warpage
- Double Sheet Detection
- Thickness
- Positioning
- Eccentricity and Surface Deflection
- DETAILED SETTINGS
- TROUBLE-SHOOTING
- SPECIFICATIONS
- INDEX
- SETTING TRANSITION CHARTS

# PNP Amplifier Unit

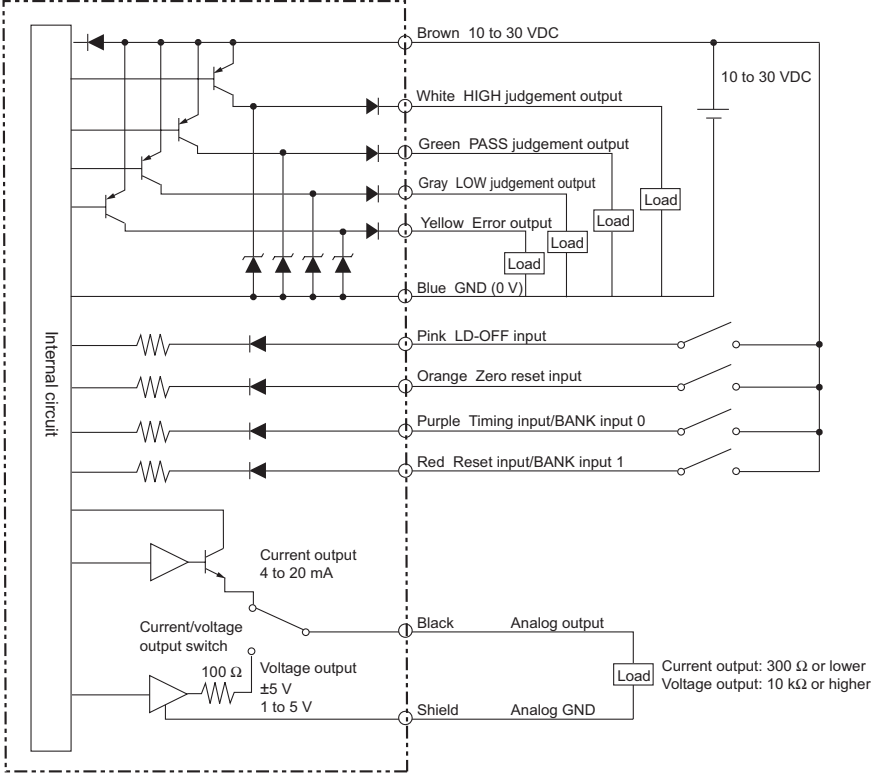



# FLOW OF OPERATION

---

# FLOW OF OPERATION

- CONTENTS
- INTRODUCTION
- PREPARATION FOR MEASUREMENT
- FLOW OF OPERATION
- BASIC SETUP
- MAIN APPLICATIONS & SETTING METHODS
- Height
- Steps and Warpage
- Double Sheet Detection
- Thickness
- Positioning
- Eccentricity and Surface Deflection
- DETAILED SETTINGS
- TROUBLE-SHOOTING
- SPECIFICATIONS
- INDEX
- SETTING TRANSITION CHARTS

## Preparation for Measurement

Installing the Sensor p. 23

Wiring Diagram p. 28

## Setup

### <Simple Measurement>

- Basic Setup p. 38

### <Setting Up by 6 Measurement Contents>

- Measuring Height and Dimensions p. 40

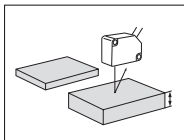

- Measuring Steps and Warpage p. 45

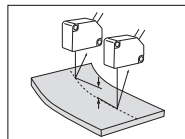
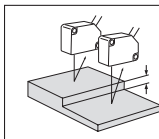

- Detecting Double Sheet Detection p. 50

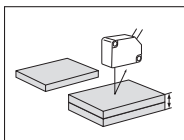

- Measuring Thickness and Insertion p. 55

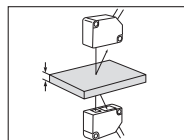

- Positioning p. 64

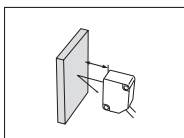

- Detecting Eccentricity and Surface Deflection p. 70

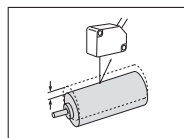



## Detailed Settings

- Smart Tuning (Optimizing the Sensing Conditions) p. 78
- Connecting Two or More Amplifier Units p. 82
- Mutual Interference Prevention p. 84
- Setting the Hysteresis p. 87
- (Improving Unstable Measurement Near the Judgement Threshold)
- Setting Hold (Holding Measured Values Under Special Conditions) p. 89
- Bank Setting p. 95
- Zero Reset p. 97
- Scaling (Changing Digital Values for Specific Measured Values) p. 101
- Analog Output p. 105
- Output for Non-measurement p. 107
- (Output Setting During Input of the Reset Signal at an Error)
- Timer p. 110
- Setting the Differential Function p. 112
- External Input for Bank, Timing Input, Reset Input p. 114
- Setting the Detection Surface Selection p. 116
- (Decreasing Incorrect Measurement Caused by Multireflection on Workpiece)
- Key Lock Function p. 118
- Initializing Setting Data p. 119

## When an Error Occurs

- Troubleshooting p. 124
- Error Messages p. 126
- Q&A p. 129

## Engineering Data etc

- Function Transition Charts p. 148
- Specifications and Dimensions p. 132
- Timing Charts p. 137
- Engineering Data (Typical) p. 140
  
- Index p. 143

CONTENTS

INTRODUCTION

PREPARATION FOR MEASUREMENT

FLOW OF OPERATION

BASIC SETUP

MAIN APPLICATIONS & SETTING METHODS

Height

Steps and Warpage

Double Sheet Detection

Thickness

Positioning

Eccentricity and Surface Deflection

DETAILED SETTINGS

TROUBLE-SHOOTING

SPECIFICATIONS

INDEX

SETTING TRANSITION CHARTS

CONTENTS

INTRODUCTION

PREPARATION  
FOR  
MEASUREMENT

**FLOW OF  
OPERATION**

BASIC  
SETUP

MAIN  
APPLICATIONS  
& SETTING  
METHODS

Height

Steps  
and  
Warpage

Double  
Sheet  
Detection

Thickness

Positioning

Eccentricity  
and Surface  
Deflection

DETAILED  
SETTINGS

TROUBLE-  
SHOOTING

SPECIFI-  
CATIONS

INDEX

SETTING  
TRANSITION  
CHARTS

# BASIC SETUP

---

BASIC SETUP

38

# BASIC SETUP

Default Settings	p.119
Initializing Settings	p.119
Setting Transition Charts	p.148

## Display of RUN Mode

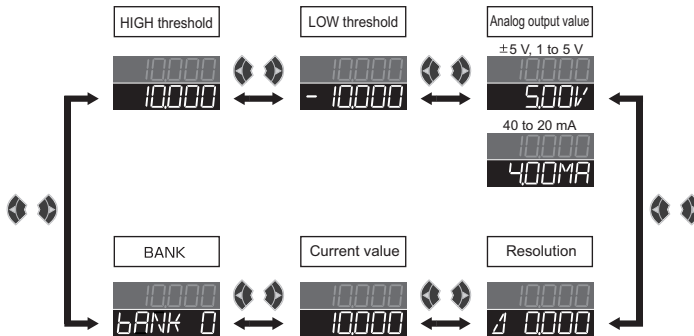





\*1 The main display always shows the measured value.  
 Default measured values are as follows:  
 0 reference: Measurement center distance,  
 + indication: NEAR side  
 - indication: FAR side  
 \* The numerals shown in the above diagram are an example only. The actual display may be different.

## Simplest Setting

### Smart Tuning (Single Smart Tuning)

Smart tuning sets optimum sensing conditions according to the operating conditions (response time and color/state of workpiece)

Button Operation	Display	Description of Operation	Explanation of Selection Menu
—	—	Set the reference workpiece in place, adjust the position of the Sensor Head while looking at the digital display values on the Amplifier Unit or the indicators on the Sensor Head so that the distance between the Sensor Head and the workpiece is the measurement center distance, and install the Sensor Head at this position.	
  Hold down for 1 second	Pressing down  Pressed down  Flashing	Press the  button for one second. When SMART SINGLE is displayed, release your finger from the button to start execution of smart tuning.	If "FAILED" flashes on the sub-display for three seconds, it indicates that tuning was not possible. Change the response time setting to a larger value, and try again.

\* To tune multiple workpieces or to tune workpieces having a different surface condition: **page 78**

# MAIN APPLICATIONS & SETTING METHODS

<b>Height</b>	<b>40</b>
<b>Steps and Warpage</b>	<b>45</b>
<b>Double Sheet Detection</b>	<b>50</b>
<b>Thickness</b>	<b>55</b>
<b>Positioning</b>	<b>64</b>
<b>Eccentricity and Surface Deflection</b>	<b>70</b>

# Height

- CONTENTS
- INTRODUCTION
- PREPARATION FOR MEASUREMENT
- FLOW OF OPERATION
- BASIC SETUP
- MAIN APPLICATIONS & SETTING METHODS
- Height
- Steps and Warpage
- Double Sheet Detection
- Thickness
- Positioning
- Eccentricity and Surface Deflection
- DETAILED SETTINGS
- TROUBLE-SHOOTING
- SPECIFICATIONS
- INDEX
- SETTING TRANSITION CHARTS

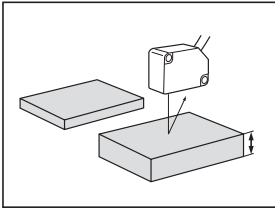

## Procedure for setting up height

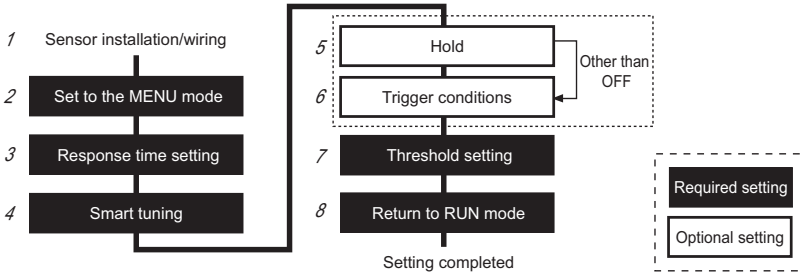











### 1 Sensor installation/wiring **Required**

Has the Sensor been installed and wired? **(See page 23.)**



Set the reference workpiece in place, adjust the position of the Sensor Head while looking at the digital display values on the Amplifier Unit or the indicators on the Sensor Head so that the height to be measured is near the measurement center distance, and install the Sensor Head at this position.

### 2 Set to the MENU mode **Required**

Select the desired mode to set the measurement conditions in.











Button Operation	Display	Description of Operation	Explanation of Selection Menu
  Hold down for 3 seconds	 	Hold down the  button for three seconds to switch to the MENU mode.	
 Press to display.		Press the  button to display dETAIL L.	* This operation is not required when hold and trigger conditions are not to be set.
 Press to display.		Press the  button to set the display to ON to set display of the detail menu.	



Button Operation	Display	Description of Operation	Explanation of Selection Menu
 		Press the  button to apply the setting.	

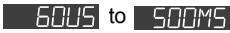



### 3 Response time setting **Required**

Select the response time to match the size and moving speed of the sensing object.

Button Operation	Display	Description of Operation	Explanation of Selection Menu
 Press to display		Press the  button to display <i>SPEED</i> .	<div style="border: 1px solid black; padding: 5px; display: inline-block;">Default value: 500 ms</div>
 Press to select	 Select the desired value.	Press the  button to select the response time.	Select the response time to match the size and moving speed of the sensing object. <div style="border: 1px solid black; padding: 5px; display: inline-block;">  </div> <div style="border: 1px solid black; padding: 5px; display: inline-block;">           60 <math>\mu</math>s, 120 <math>\mu</math>s, 240 <math>\mu</math>s, 500 <math>\mu</math>s,            1 ms, 2 ms, 4 ms, 8 ms, 12 ms,            20 ms, 36 ms, 66 ms, 128 ms,            250 ms, 500 ms         </div>
 		Press the  button to apply the setting.	* After the response time is changed, the smart tuning results are cleared, so be sure to re-execute tuning.

Smart tuning sets optimum sensing conditions according to the operating conditions (response time and color/state of workpiece)

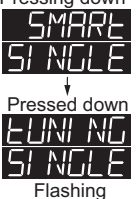







### 4 Smart tuning **Required**

Button Operation	Display	Description of Operation	Explanation of Selection Menu
—	—	Check that the reference workpiece is set in place.	
  Hold down for 1 second		Press the  button for one second. When <i>SMART SINGLE</i> is displayed, release your finger from the button to start execution of smart tuning.	<div style="border: 1px dashed black; padding: 5px;">           If "FAILED" flashes on the sub-display for three seconds, it indicates that tuning was not possible. Change the response time setting to a larger value, and try again.         </div>

\* To tune multiple workpieces or to tune workpieces having a different surface condition: **page 78**

## 5 Hold Optional

Set this item to hold measured values during the measurement period according to preset hold conditions.



Button Operation	Display	Description of Operation	Explanation of Selection Menu
		Press the  button to display <i>HOLD</i> .	Default value: OFF
	 <p>Select the desired value.</p>	Press the  button to select the hold conditions.	<div style="border: 1px solid black; padding: 2px; margin-bottom: 5px;"><i>OFF</i></div> Hold OFF <div style="border: 1px solid black; padding: 2px; margin-bottom: 5px;"><i>AVE</i></div> The average measured value during the sampling period is held. <div style="border: 1px solid black; padding: 2px; margin-bottom: 5px;"><i>PEP</i></div> The difference between the minimum and maximum values during the sampling period is held. <div style="border: 1px solid black; padding: 2px; margin-bottom: 5px;"><i>SAMPLE</i></div> The measured value at the start of the sampling period is held. <div style="border: 1px solid black; padding: 2px; margin-bottom: 5px;"><i>BOTTOM</i></div> The minimum value during the sampling period is held. <div style="border: 1px solid black; padding: 2px; margin-bottom: 5px;"><i>PEAK</i></div> The maximum value during the sampling period is held. <b>(For details, see page 91.)</b>
		Press the  button to apply the setting.	* The clamp value is output until the first sampling period is finished. <b>(For details on the clamp value, see page 107.)</b>



















}

When other than *OFF* is selected, proceed to "6 Trigger conditions," and when *OFF* is selected, proceed to "7 Threshold setting."

## 6 Trigger conditions Optional













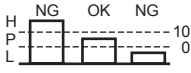









Set how timing of the hold measurement period is to be input.

Button Operation	Display	Description of Operation	Explanation of Selection Menu
		Press the  button to display <i>TRIG</i> .	Default value: TIMING

Button Operation	Display	Description of Operation	Explanation of Selection Menu
 <p>Press to select</p>	 <p>Select the desired value.</p>	<p>Press the  button to select the trigger conditions.</p>	<p><b>E1 MI NG</b></p> <p>Enter the trigger by using the timing input or by pressing the  button in the RUN mode. The period that the timing signal is ON is the sampling period.</p> <p><b>SELF-d</b></p> <p>The sampling period is the period that the measured value is lower than the specified self-trigger level.</p> <p><b>SELF-U</b></p> <p>The sampling period is the period that the measured value is greater than the specified self-trigger level.</p> <p><b>(For details, see page 93.)</b></p>
<p>SMART MENU/SET</p> 		<p>Press the  button to apply the trigger conditions.</p> <p>(When <b>SELF-U</b> and <b>SELF-d</b> are selected, proceed to the next item, and when <b>E1 MI NG</b> is selected, proceed to "7 Threshold setting.")</p>	
 <p>Press to display</p>		<p>Press the  button to display <b>SELF LV</b>.</p>	<p>Default value: 0.000</p>
		<p>Press the  button to enable setting of the self-trigger level.</p>	
<p>[Change numeric value]</p>  <p>Press to set.</p>	 <p>Set any value.</p>	<p>Press the  button to move the digit, press the  button to change the numeric value, and set the self-trigger level.</p>	<p>* If the  button is pressed when the cursor is at the right-most digit or the  button is pressed when the cursor is at the left-most digit, the setting will be canceled.</p>
<p>SMART MENU/SET</p> 		<p>Press the  button to apply the setting.</p>	



# 7 Threshold setting **Required**

Set the range of measured values to be judged as PASS by setting the HIGH and LOW thresholds.

CONTENTS	Button Operation	Display	Description of Operation	Explanation of Selection Menu
INTRODUCTION	 Press to set.	Lit H L MENU	Press the  button to display the HIGH threshold.	Setting example: Non-defective product height 0 to 10 mm 
PREPARATION FOR MEASUREMENT			Press the  button to enable setting of the HIGH threshold.	
FLOW OF OPERATION	 [Change numeric value] Press to set.		Press the  button to move the digit, press the  button to change the numeric value, and set the HIGH threshold. Set any value.	Set the MAX and MIN heights to be regarded as OK to the HIGH and LOW thresholds, respectively.  * If the  button is pressed when the cursor is at the right-most digit or the  button is pressed when the cursor is at the left-most digit, the setting will be canceled.
BASIC SETUP			Press the  button to apply the setting.	
MAIN APPLICATIONS & SETTING METHODS	 Press to set.	Lit H L MENU	Press the  button to display the LOW threshold.	* Set so that the HIGH threshold is greater than the LOW threshold.
Height			Press the  button to enable setting of the LOW threshold.	
Steps and Warpage	 [Change numeric value] Press to set.		Press the  button to move the digit, press the  button to change the numeric value, and set the LOW threshold. Set any value.	
Double Sheet Detection			Press the  button to apply the setting.	

# 8 Return to RUN mode **Required**

Switch to the mode in which measurement is performed.

CONTENTS	Button Operation	Display	Description of Operation	Explanation of Selection Menu
TRUBLE-SHOOTING	 Hold down for 3 seconds	H L Out MENU	Hold down the  button for three seconds to switch to the RUN mode.	

\* For details on optimizing settings, such as output and input, see "Detailed Settings." Example (Setting the reference height to 0 (or the offset value): **Zero Reset** → page 97.)

# Steps and Warpage

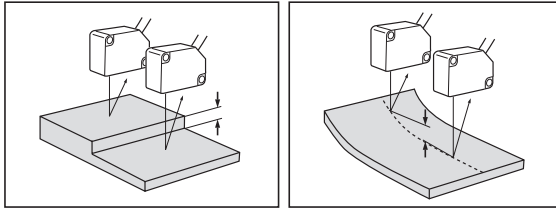

## Procedure for setting up steps and warpage

The Amplifier Units to set up differ depending on whether mutual interference prevention is set to ON or OFF.

Note that different channels are used to specify each menu item, as shown below.

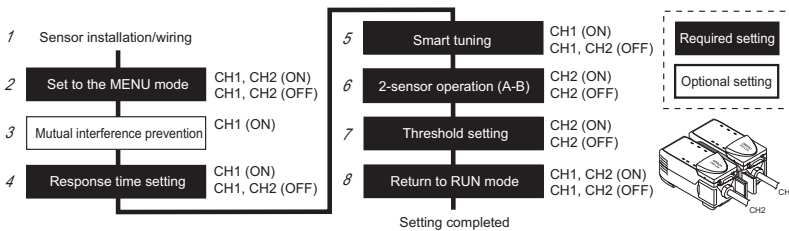

ON: Mutual interference prevention is ON  
OFF: Mutual interference prevention is OFF

## 1 Sensor installation/wiring **Required**

Has the Sensor been installed and wired? (See page 23.)

Connect two Amplifier Units with a Calculating Unit in between. (The calculation result is displayed and output on the CH2 Amplifier Unit.)

Set the reference workpiece in place, adjust the position of the Sensor Head while looking at the digital display values on the Amplifier Unit or the indicators on the Sensor Head so that each of the heights to be measured is near the measurement center distance, and install the Sensor Head at this position.

## 2 Set to the MENU mode **Required**

Select the desired mode to set the measurement conditions in.

(Use CH1 and CH2 for these settings.)

Button Operation	Display	Description of Operation	Explanation of Selection Menu
 Hold down for 3 seconds	 Lit MENU	Hold down the  button for three seconds to switch to the MENU mode.	

CONTENTS

INTRODUCTION

PREPARATION FOR MEASUREMENT

FLOW OF OPERATION

BASIC SETUP

MAIN APPLICATIONS & SETTING METHODS

Height

Steps and Warpage

Double Sheet Detection

Thickness

Positioning

Eccentricity and Surface Deflection









DETAILED SETTINGS

TROUBLE-SHOOTING









SPECIFICATIONS

INDEX

SETTING TRANSITION CHARTS



Button Operation	Display	Description of Operation	Explanation of Selection Menu
 Press to display.		Press the  button to display <i>DETAIL</i> .	
 Press to display.		Press the  button to set the display to <i>ON</i> to set display of the detail menu.	
 		Press the  button to apply the setting.	

### 3 Mutual interference prevention **Optional** Set this item to prevent the influence of mutual interference between two Sensor Heads. (Use CH1 for these settings.)







Button Operation	Display	Description of Operation	Explanation of Selection Menu
 Press to display.		Press the  button on the CH1 Amplifier Unit to display <i>SYNC</i> .	<div style="border: 1px solid black; padding: 2px;">Default value: OFF</div>
 Press to display.		Press the  button to display <i>ON</i> .	
 		Press the  button to apply the setting.	* For details on the response time when connecting two or more Amplifier Units, see page 82.

### 4 Response time setting **Required** Select the response time to match the size and moving speed of the sensing object.

If mutual interference prevention is ON: Use CH1 for these settings.  
 If mutual interference prevention is set to OFF: Use CH1 and CH2 for these settings.

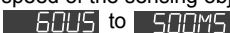
Button Operation	Display	Description of Operation	Explanation of Selection Menu
 Press to display.		Press the  button to display <i>SPEED</i> .	<div style="border: 1px solid black; padding: 2px;">Default value: 500 ms</div>





CONTENTS
INTRODUCTION
PREPARATION FOR MEASUREMENT
FLOW OF OPERATION
BASIC SETUP
MAIN APPLICATIONS & SETTING METHODS
Height
Steps and Warpage
Double Sheet Detection
Thickness
Positioning
Eccentricity and Surface Deflection
DETAILED SETTINGS
TROUBLE-SHOOTING
SPECIFICATIONS
INDEX
SETTING TRANSITION CHARTS

Button Operation	Display	Description of Operation	Explanation of Selection Menu
 Press to select	 Select the desired value.	Press the  button to select the response time.	Select the response time to match the size and moving speed of the sensing object.  { 60 μs, 120 μs, 240 μs, 500 μs, 1 ms, 2 ms, 4 ms, 8 ms, 12 ms, 20 ms, 36 ms, 66 ms, 128 ms, 250 ms, 500 ms }
 		Press the  button to apply the setting.	* After the response time is changed, the smart tuning results are cleared, so be sure to re-execute tuning.

## 5 Smart tuning **Required**

Smart tuning sets optimum sensing conditions according to the operating conditions (response time and color/state of workpiece)

If mutual interference prevention is ON: Use CH1 for these settings.  
 If mutual interference prevention is set to OFF: Use CH1 and CH2 for these settings.









Button Operation	Display	Description of Operation	Explanation of Selection Menu
—	—	Check that the reference workpiece is set in place.	
  Hold down for 1 second	 ↓  Flashing	Press the  button for one second. When <i>SMART SINGLE</i> is displayed, release your finger from the button to start execution of smart tuning.	if "FAILED" flashes on the sub-display for three seconds, it indicates that tuning was not possible. Change the response time setting to a larger value, and try again. * If mutual interference prevention is set to ON, after smart tuning execution for CH1 ends, it is also executed for the Amplifier Units of CH2 and later. If the tuning result is NG for either Amplifier Unit, the smart tuning setup results are not applied to any amplifier units.

\* To tune multiple workpieces or to tune workpieces having a different surface condition: **page 78**

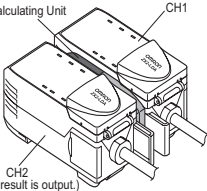
## 6 2-sensor operation (A-B) **Required**

Set this item when calculating the difference between the measurement results from two Sensor Heads.



(Use CH2 for these settings.)

Button Operation	Display	Description of Operation	Explanation of Selection Menu
 Press to display		Press the  button on the CH2 Amplifier Unit to display <b>CALC</b> .	 CH1 CH2 (Calculation result is output.)
 Press to select		Press the  button to display <b>A-b</b> .	
 		Press the  button to apply the setting.	* For details on the response time when connecting two or more Amplifier Units, see page 82.

## 7 Threshold setting **Required**

Set the range of measured values to be judged as **PASS** by setting the **HIGH** and **LOW** thresholds.

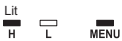
(Use CH2 for these settings.)

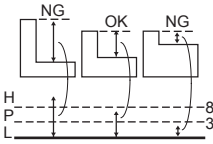
Button Operation	Display	Description of Operation	Explanation of Selection Menu
 Press to display		Press the  button on the CH2 Amplifier Unit to display the <b>HIGH</b> threshold.	Setting example: Non-defective product step 3 to 8 mm 
			Set the <b>MAX</b> and <b>MIN</b> steps to be regarded as <b>OK</b> to the <b>HIGH</b> and <b>LOW</b> thresholds, respectively.



Button Operation	Display	Description of Operation	Explanation of Selection Menu
		Press the  button to enable setting of the HIGH threshold.	* If the  button is pressed when the cursor is at the right-most digit or the  button is pressed when the cursor is at the left-most digit, the setting will be canceled.  * Set so that the HIGH threshold is greater than the LOW threshold.
[Change numeric value] [Move digit]  Press to set.	 Set any value.	Press the  button to move the digit, press the  button to change the numeric value, and set the HIGH threshold.	
SMART MENU/SET 		Press the  button to apply the setting.	
 Press to display	 Press the  button to display the LOW threshold.	Press the  button to display the LOW threshold.	
		Press the  button to enable setting of the LOW threshold.	
[Change numeric value] [Move digit]  Press to set.	 Set any value.	Press the  button to move the digit, press the  button to change the numeric value, and set the LOW threshold.	
SMART MENU/SET 		Press the  button to apply the setting.	

## 8 Return to RUN mode **Required**

Switch to the mode in which measurement is performed.

(Use CH1 and CH2 for these settings.)

Button Operation	Display	Description of Operation	Explanation of Selection Menu
SMART MENU/SET  Hold down for 3 seconds	 Hold down the  button for three seconds to switch to the RUN mode.	Hold down the  button for three seconds to switch to the RUN mode.	

\* For details on optimizing settings, such as output and input, see "DETAILED SETTINGS."

# Double Sheet Detection

- CONTENTS
- INTRODUCTION
- PREPARATION FOR MEASUREMENT
- FLOW OF OPERATION
- BASIC SETUP
- MAIN APPLICATIONS & SETTING METHODS
- Height
- Steps and Warpage
- Double Sheet Detection
- Thickness
- Positioning
- Eccentricity and Surface Deflection
- DETAILED SETTINGS
- TROUBLE-SHOOTING
- SPECIFICATIONS
- INDEX
- SETTING TRANSITION CHARTS

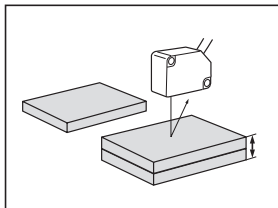

## Procedure for setting up double sheet detection

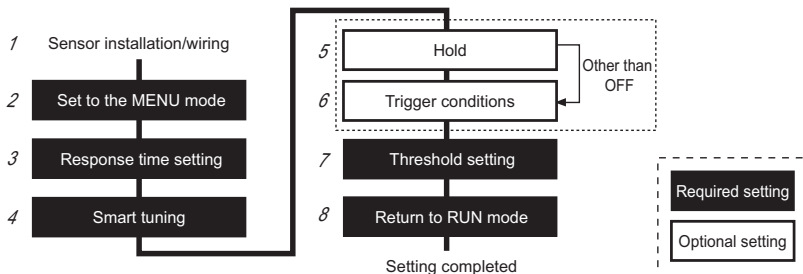











### 1 Sensor installation/wiring **Required**



Has the Sensor been installed and wired? (See page 23.)

Set the reference workpiece in place, adjust the position of the Sensor Head while looking at the digital display values on the Amplifier Unit or the indicators on the Sensor Head so that the measured value at measurement of one product and at measurement of two products is within the measurement range, and install the Sensor Head at this position.

### 2 Set to the MENU mode **Required**

Select the desired mode to set the measurement conditions in.

Button Operation	Display	Description of Operation	Explanation of Selection Menu
  Hold down for 3 seconds	 	Hold down the  button for three seconds to switch to the MENU mode.	
 Press to display		Press the  button to display dEtAl L.	* This operation is not required when hold and trigger conditions are not to be set.
 Press to display.		Press the  button to set the display to ON to set display of the detail menu.	









Button Operation	Display	Description of Operation	Explanation of Selection Menu
 		Press the  button to apply the setting.	

CONTENTS

### 3 Response time setting **Required**

Select the response time to match the size and moving speed of the sensing object.

INTRODUCTION

Button Operation	Display	Description of Operation	Explanation of Selection Menu
 Press to display		Press the  button to display <i>SPEED</i> .	<div style="border: 1px solid black; padding: 5px; display: inline-block;">Default value: 500 ms</div>
 Press to select	 Select the desired value.	Press the  button to select the response time.	Select the response time to match the size and moving speed of the sensing object. <div style="border: 1px solid black; padding: 5px; display: inline-block; margin-top: 10px;"> <i>60US</i> to <i>500MS</i> </div> <div style="border: 1px solid black; padding: 5px; margin-top: 5px;">             60 <math>\mu</math>s, 120 <math>\mu</math>s, 240 <math>\mu</math>s, 500 <math>\mu</math>s,              1 ms, 2 ms, 4 ms, 8 ms, 12 ms,              20 ms, 36 ms, 66 ms, 128 ms,              250 ms, 500 ms           </div>
 		Press the  button to apply the setting.	* After the response time is changed, the smart tuning results are cleared, so be sure to re-execute tuning.

PREPARATION FOR MEASUREMENT

FLOW OF OPERATION

BASIC SETUP

MAIN APPLICATIONS & SETTING METHODS

Height

Steps and Warpage

Double Sheet Detection







Thickness

Positioning

Eccentricity and Surface Deflection

### 4 Smart tuning **Required**

Smart tuning sets optimum sensing conditions according to the operating conditions (response time and color/state of workpiece)

Button Operation	Display	Description of Operation	Explanation of Selection Menu
—	—	Check that the reference workpiece is set in place.	
  Hold down for 1 second	 Pressing down  Pressed down  Flashing	Press the  button for one second. When <i>SMART SINGLE</i> is displayed, release your finger from the button to start execution of smart tuning.	<div style="border: 1px dashed black; padding: 5px;">           If "<i>FAILED</i>" flashes on the sub-display for three seconds, it indicates that tuning was not possible. Change the response time setting to a larger value, and try again.         </div>

DETAILED SETTINGS

TROUBLE-SHOOTING

SPECIFICATIONS















INDEX

\* To tune multiple workpieces or to tune workpieces having a different surface condition: **page 78**

SETTING TRANSITION CHARTS



## 5 Hold Optional



















Set this item to hold measured values during the measurement period according to preset hold conditions.

Button Operation	Display	Description of Operation	Explanation of Selection Menu
		Press the  button to display <i>HOLD</i> .	Default value: OFF
	 <p>Select the desired value.</p>	Press the  button to select the hold conditions.	 Hold OFF  The average measured value during the sampling period is held.  The difference between the minimum and maximum values during the sampling period is held.  The measured value at the start of the sampling period is held.  The minimum value during the sampling period is held.  The maximum value during the sampling period is held. <b>(For details, see page 91.)</b>
		Press the  button to apply the setting.	* The clamp value is output until the first sampling period is finished. <b>(For details on the clamp value, see page 107.)</b>
		<div style="border-left: 1px solid black; border-right: 1px solid black; padding: 10px;">                     (When other than <i>OFF</i> is selected, proceed to "6 Trigger conditions," and when <i>OFF</i> is selected, proceed to "7 Threshold setting.")                 </div>	

## 6 Trigger conditions Optional

Set how timing of the hold measurement period is to be input.

Button Operation	Display	Description of Operation	Explanation of Selection Menu
		Press the  button to display <i>TRIG</i> .	Default value: TIMING

Button Operation	Display	Description of Operation	Explanation of Selection Menu
 <p>Press to select</p>	 <p>Select the desired value.</p>	Press the  button to select the trigger conditions.	<p><b>E1 MI NG</b></p> <p>Enter the trigger by using the timing input or by pressing the  button in the RUN mode. The period that the timing signal is ON is the sampling period.</p> <p><b>SELF-d</b></p> <p>The sampling period is the period that the measured value is lower than the specified self-trigger level.</p> <p><b>SELF-U</b></p> <p>The sampling period is the period that the measured value is greater than the specified self-trigger level.  <b>(For details, see page 93.)</b></p>
		Press the  button to apply the trigger conditions.  (When <b>SELF-U</b> and <b>SELF-d</b> are selected, proceed to the next item, and when <b>E1 MI NG</b> is selected, proceed to "7 Threshold setting.")	
 <p>Press to display</p>		Press the  button to display <b>SELF LV</b> .	<div style="border: 1px solid black; padding: 2px;">Default value: 0.000</div>
		Press the  button to enable setting of the self-trigger level.	
[Change numeric value]  <p>Press to set.</p>	 <p>Set any value.</p>	Press the  button to move the digit, press the  button to change the numeric value, and set the self-trigger level.	* If the  button is pressed when the cursor is at the right-most digit or the  button is pressed when the cursor is at the left-most digit, the setting will be canceled.
		Press the  button to apply the setting.	

CONTENTS

INTRODUCTION

PREPARATION FOR MEASUREMENT

FLOW OF OPERATION

BASIC SETUP

MAIN APPLICATIONS &amp; SETTING METHODS

Height

Steps and Warpage

Double Sheet Detection

Thickness

Positioning

Eccentricity and Surface Deflection

DETAILED SETTINGS

TROUBLE-SHOOTING























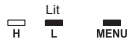

SPECIFICATIONS

INDEX

SETTING TRANSITION CHARTS



# 7 Threshold Setting **Required**

Set the range of measured values to be judged as **PASS** by setting the **HIGH** and **LOW** thresholds.

CONTENTS	Button Operation	Display	Description of Operation	Explanation of Selection Menu
INTRODUCTION	 Press to display.		Press the  button to display the <b>HIGH</b> threshold.	Examples: 
PREPARATION FOR MEASUREMENT			Press the  button to enable setting of the <b>HIGH</b> threshold.	Set the <b>HIGH</b> and <b>LOW</b> thresholds right in the middle of the measured values of sheets 1 and 2 and sheets 1 and 0, respectively.
FLOW OF OPERATION	 [Change numeric value] [Numeric value] Press to set.	 Set any value.	Press the  button to move the digit, press the  button to change the numeric value, and set the <b>HIGH</b> threshold.	
BASIC SETUP			Press the  button to apply the setting.	* If the  button is pressed when the cursor is at the right-most digit or the  button is pressed when the cursor is at the left-most digit, the setting will be canceled.
MAIN APPLICATIONS & SETTING METHODS	 Press to display.		Press the  button to display the <b>LOW</b> threshold.	
Height			Press the  button to enable setting of the <b>LOW</b> threshold.	* Set so that the <b>HIGH</b> threshold is greater than the <b>LOW</b> threshold.
Steps and Warpage	 [Change numeric value] [Numeric value] Press to set.	 Set any value.	Press the  button to move the digit, press the  button to change the numeric value, and set the <b>LOW</b> threshold.	
Double Sheet Detection			Press the  button to apply the setting.	
Thickness				
Positioning				
Eccentricity and Surface Deflection				

# 8 Return to RUN mode **Required**

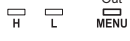
Switch to the mode in which measurement is performed.

CONTENTS	Button Operation	Display	Description of Operation	Explanation of Selection Menu
TROUBLE-SHOOTING	 Hold down for 3 seconds		Hold down the  button for three seconds to switch to the <b>RUN</b> mode.	
SPECIFICATIONS				
INDEX				

\* For details on optimizing settings, such as output and input, see "Detailed Settings." Example (Setting the reference height to 0 (or the offset value): **Zero Reset** → page 97)

# Thickness

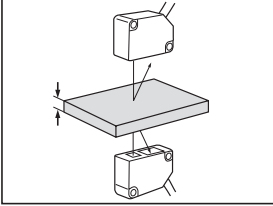

## Procedure for setting up thickness

The Amplifier Units to set up differ for each menu. Note also that different channels are used to specify each menu item, as shown below.

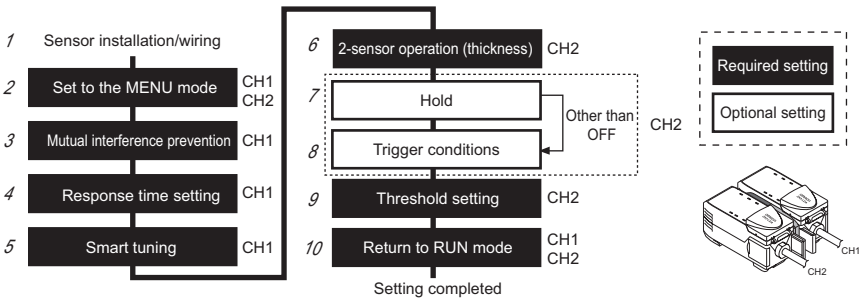

## 1 Sensor installation/wiring **Required**

Has the Sensor been installed and wired? (See page 23.)

Connect two Amplifier Units with a Calculating Unit in between. (The calculation result is displayed and output on the CH2 Amplifier Unit.)

Set up the two Sensor Heads so that they are facing each other, adjust the positions of the Sensor Heads while looking at the digital display values on the Amplifier Units or the indicators on the Sensor Heads so that the clearance between the sensing object and each Sensor Head is near the measurement center distance, and install the Sensor Heads at these positions.

Prepare a reference sensing object of known thickness.

## 2 Set to the MENU mode **Required**

Select the desired mode to set the measurement conditions in.

(Use CH1 and CH2 for these settings.)

Button Operation	Display	Description of Operation	Explanation of Selection Menu
<p>Hold down for 3 seconds</p>		Hold down the  button for three seconds to switch to the MENU mode.	

CONTENTS

INTRODUCTION

PREPARATION FOR MEASUREMENT

FLOW OF OPERATION

BASIC SETUP

MAIN APPLICATIONS & SETTING METHODS

Height

Steps and Warpage

Double Sheet Detection

Thickness

Positioning

Eccentricity and Surface Deflection









DETAILED SETTINGS

TROUBLE-SHOOTING

SPECIFICATIONS









INDEX

SETTING TRANSITION CHARTS

Button Operation	Display	Description of Operation	Explanation of Selection Menu
 Press to display.		Press the  button to display <i>DETAIL</i> .	
 Press to display.		Press the  button to set the display to <i>ON</i> to set display of the detail menu.	
 		Press the  button to apply the setting.	



### 3 Mutual interference prevention **Required** Set this item to prevent the influence of mutual interference between two Sensor Heads.

(Use CH1 for these settings.)

Button Operation	Display	Description of Operation	Explanation of Selection Menu
 Press to display.		Press the  button on the CH1 Amplifier Unit to display <i>SYNC</i> .	<div style="border: 1px solid black; padding: 2px;">Default value: OFF</div>
 Press to display.		Press the  button to display <i>ON</i> .	
 		Press the  button to apply the mutual interference prevention setting.	* For details on the response time when connecting two or more Amplifier Units, see page 82.





### 4 Response time setting **Required** Select the response time to match the size and moving speed of the sensing object.

(Use CH1 for these settings.)

Button Operation	Display	Description of Operation	Explanation of Selection Menu
 Press to display.		Press the  button on the CH1 Amplifier Unit to display <i>SPEED</i> .	<div style="border: 1px solid black; padding: 2px;">Default value: 500 ms</div>



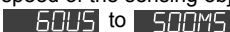



CONTENTS
INTRODUCTION
PREPARATION FOR MEASUREMENT
FLOW OF OPERATION
BASIC SETUP
MAIN APPLICATIONS & SETTING METHODS
Height
Steps and Warpage
Double Sheet Detection
Thickness
Positioning
Eccentricity and Surface Deflection
DETAILED SETTINGS
TROUBLE-SHOOTING
SPECIFICATIONS
INDEX
SETTING TRANSITION CHARTS

Button Operation	Display	Description of Operation	Explanation of Selection Menu
 Press to select	 Select the desired value.	Press the  button to select the response time.	Select the response time to match the size and moving speed of the sensing object.  { 60 $\mu$ s, 120 $\mu$ s, 240 $\mu$ s, 500 $\mu$ s, 1 ms, 2 ms, 4 ms, 8 ms, 12 ms, 20 ms, 36 ms, 66 ms, 128 ms, 250 ms, 500 ms }
		Press the  button to apply the setting.	* After the response time is changed, the smart tuning results are cleared, so be sure to re-execute tuning.

## 5 Smart tuning **Required**

Smart tuning sets optimum sensing conditions according to the operating conditions (response time and color/state of workpiece)

(Use CH1 for these settings.)











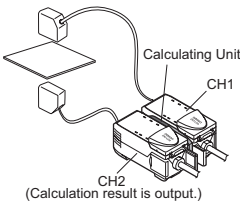





Button Operation	Display	Description of Operation	Explanation of Selection Menu
—	—	Check that the reference workpiece is set in place.	
 Hold down for 1 second	Pressing down  ↓ Pressed down  Flashing	Press the  button on the CH1 Amplifier Unit for one second. When <i>SMART/SINGLE</i> is displayed, release your finger from the button to start execution of smart tuning.	If "FAILED" flashes on the sub-display for three seconds, it indicates that tuning was not possible. Change the response time setting to a larger value, and try again. * After smart tuning execution for CH1 ends, it is also executed for the Amplifier Units of CH2 and later. If the tuning result is NG for either Amplifier Unit, the smart tuning setup results are not applied to any amplifier units.

\* To tune multiple workpieces or to tune workpieces having a different surface condition: **page 78**

# 6 2-sensor operation (thickness) **Required**

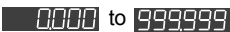
Make this initial setting to measure thickness when using two Sensor Head to measure thickness.

(Use CH2 for these settings.)

CONTENTS	Button Operation	Display	Description of Operation	Explanation of Selection Menu
INTRODUCTION	—	—	Set the reference sensing object of which thickness is known in place.	 <p>CH1 CH2 (Calculation result is output.)</p>
PREPARATION FOR MEASUREMENT			Press the  button on the CH2 Amplifier Unit to display <i>CALC</i> .	
FLOW OF OPERATION			Press the  button to display <i>THICK</i> .	
BASIC SETUP			Press the  button to apply the thickness setting.	
MAIN APPLICATIONS & SETTING METHODS	<p>[Change numeric value]</p> 	 <p>Set any value.</p>	Press the  button to move the digit, press the  button to change the numeric value, and set the thickness numeric value.	 <p>* If the  button is pressed when the cursor is at the right-most digit or the  button is pressed when the cursor is at the left-most digit, the setting will be canceled.</p>
Height			Press the  button to apply the setting.	<p>* The 2-sensor operation reference value is determined based on the measured values of CH1 and CH2 by the timing that setting of the thickness numeric values is executed.</p> <p>* For details on the response time when connecting two or more Amplifier Units, see page 82.</p>
Steps and Warpage				
Double Sheet Detection				
Thickness				
Positioning				
Eccentricity and Surface Deflection				
DETAILED SETTINGS				
TROUBLE-SHOOTING				
SPECIFICATIONS				
INDEX				
SETTING TRANSITION CHARTS				

### Important

- If analog output is to be used, the entered thickness value is used as the center value of the analog output range. (For example, 0 V is used if the analog output is  $\pm 5$  V.)
- After thickness calculation, the maximum and minimum measurement range values (CH2 measurement values) are assigned as the maximum and minimum analog output range.
- Concerning the minimum and maximum analog output values, the analog output minimum value is output for the smaller of the post-thickness calculation values, and the analog output maximum value is output for the larger of these values.

Example: If the ZX2-LD50 is used, a thickness value of 20 mm is entered, and analog output from  $-5$  to  $5$  V is specified.

Measured Value After Thickness Calculation	How the Measurement Value Is Calculated	Analog Output
10.000	Thickness value $-$ (CH2 measurement range/2) = 20.000 $-$ 10.000	$-5$ V
20.000	Thickness value = 20.000	0 V
30.000	Thickness value $+$ (CH2 measurement range/2) = 20.000 $+$ 10.000	5 V

\* The measurement range for the ZX2-LD50 is  $\pm 10$  mm.

CONTENTS

INTRODUCTION

PREPARATION FOR MEASUREMENT

FLOW OF OPERATION

BASIC SETUP

MAIN APPLICATIONS & SETTING METHODS

Height

Steps and Warpage

Double Sheet Detection

Thickness

Positioning

Eccentricity and Surface Deflection

DETAILED SETTINGS

TROUBLE-SHOOTING

SPECIFICATIONS

















INDEX

SETTING TRANSITION CHARTS

# 7 Hold Optional

Set this item to hold measured values during the measurement period according to preset hold conditions.















(Use CH2 for these settings.)

CONTENTS	Button Operation	Display	Description of Operation	Explanation of Selection Menu
INTRODUCTION	 <small>Press to display.</small>		Press the  button on the CH2 Amplifier Unit to display <i>HOLD</i> .	Default value: OFF
PREPARATION FOR MEASUREMENT	 <small>Press to select</small>	 Select the desired value.	Press the  button to select the hold conditions.	 Hold OFF
FLOW OF OPERATION				 The average measured value during the sampling period is held.
BASIC SETUP	 		Press the  button to apply the setting.	 The difference between the minimum and maximum values during the sampling period is held.
MAIN APPLICATIONS & SETTING METHODS				 The measured value at the start of the sampling period is held.
Height				 The minimum value during the sampling period is held.
Steps and Warpage				 The maximum value during the sampling period is held.
Double Sheet Detection				<b>(For details, see page 91.)</b>
Thickness				<b>(For details on the clamp value, see page 107.)</b>
Positioning	<div style="border-left: 1px solid black; border-right: 1px solid black; border-bottom: 1px solid black; padding: 10px; margin: 10px 0;">When other than <i>OFF</i> is selected, proceed to "7 Trigger conditions," and when <i>OFF</i> is selected, proceed to "9 Threshold setting."</div>	Press the  button to apply the setting.	* The clamp value is output until the first sampling period is finished.	
Eccentricity and Surface Deflection				<b>(For details on the clamp value, see page 107.)</b>
DETAILED SETTINGS				
TROUBLE-SHOOTING				
SPECIFICATIONS				
INDEX				
SETTING TRANSITION CHARTS				

# 8 Trigger conditions Optional

Set how timing of the hold measurement period is to be input.

(Use CH2 for these settings.)

Button Operation	Display	Description of Operation	Explanation of Selection Menu
		Press the  button on the CH2 Amplifier Unit to display <i>TRIG</i> .	<span style="border: 1px solid black; padding: 2px;">Default value: TIMING</span>
	 Select the desired value.	Press the  button to select the trigger conditions.	<b>EIMING</b> Enter the trigger by using the timing input or by pressing the  button in the RUN mode. The period that the timing signal is ON is the sampling period. <b>SELF-d</b> The sampling period is the period that the measured value is lower than the specified self-trigger level. <b>SELF-U</b> The sampling period is the period that the measured value is greater than the specified self-trigger level. <b>(For details, see page 93.)</b>
 		Press the  button to apply the trigger conditions.  (When <i>SELF-U</i> and <i>SELF-d</i> are selected, proceed to the next item, and when <i>EIMING</i> is selected, proceed to "9 Threshold setting.")	
		Press the  button to display <i>SELFV</i> .	<span style="border: 1px solid black; padding: 2px;">Default value: 0.000</span>
		Press the  button to enable setting of the self-trigger level.	

CONTENTS

INTRODUCTION

PREPARATION FOR MEASUREMENT

FLOW OF OPERATION

BASIC SETUP

MAIN APPLICATIONS & SETTING METHODS

Height

Steps and Warpage

Double Sheet Detection

Thickness

Positioning

Eccentricity and Surface Deflection









DETAILED SETTINGS

TROUBLE-SHOOTING

SPECIFICATIONS

INDEX















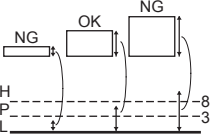







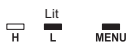

SETTING TRANSITION CHARTS

Button Operation	Display	Description of Operation	Explanation of Selection Menu
[Change numeric value]  Press to set.	 Set any value.	Press the  button to move the digit, press the  button to change the numeric value, and set the self-trigger level.	* If the  button is pressed when the cursor is at the right-most digit or the  button is pressed when the cursor is at the left-most digit, the setting will be canceled.
SMART MENU/SET  		Press the  button to apply the setting.	

## 9 Threshold Setting **Required**

Set the range of measured values to be judged as PASS by setting the HIGH and LOW thresholds.







(Use CH2 for these settings.)

Button Operation	Display	Description of Operation	Explanation of Selection Menu
 Press to display.		Press the  button on the CH2 Amplifier Unit to display the HIGH threshold.	Setting example: Non-defective product thickness 3 to 8 mm
 Press to display.		Press the  button to enable setting of the HIGH threshold.	
[Change numeric value]  Press to set.	 Set any value.	Press the  button to move the digit, press the  button to change the numeric value, and set the HIGH threshold.	Set the MAX and MIN thicknesses to be regarded as OK to the HIGH and LOW thresholds, respectively.
SMART MENU/SET  		Press the  button to apply the setting.	* If the  button is pressed when the cursor is at the right-most digit or the  button is pressed when the cursor is at the left-most digit, the setting will be canceled.
 Press to display.		Press the  button to display the LOW threshold.	
 Press to display.		Press the  button to enable setting of the LOW threshold.	* Set so that the HIGH threshold is greater than the LOW threshold.
[Change numeric value]  Press to set.	 Set any value.	Press the  button to move the digit, press the  button to change the numeric value, and set the LOW threshold.	
SMART MENU/SET  		Press the  button to apply the setting.	

# 10 Return to RUN mode **Required**

Switch to the mode in which measurement is performed.

(Use CH1 and CH2 for these settings.)

Button Operation	Display	Description of Operation	Explanation of Selection Menu
  Hold down for 3 seconds	  	Hold down the  button for three seconds to switch to the RUN mode.	

\* For details on optimizing settings, such as output and input, see "DETAILED SETTINGS."

CONTENTS

INTRODUCTION

PREPARATION FOR MEASUREMENT

FLOW OF OPERATION

BASIC SETUP

MAIN APPLICATIONS & SETTING METHODS

Height

Steps and Warpage

Double Sheet Detection

Thickness

Positioning

Eccentricity and Surface Deflection

DETAILED SETTINGS

TROUBLE-SHOOTING

SPECIFICATIONS

INDEX

SETTING TRANSITION CHARTS

# Positioning

- CONTENTS
- INTRODUCTION
- PREPARATION FOR MEASUREMENT
- FLOW OF OPERATION
- BASIC SETUP
- MAIN APPLICATIONS & SETTING METHODS
- Height
- Steps and Warpage
- Double Sheet Detection
- Thickness
- Positioning
- Eccentricity and Surface Deflection
- DETAILED SETTINGS
- TROUBLE-SHOOTING
- SPECIFICATIONS
- INDEX
- SETTING TRANSITION CHARTS

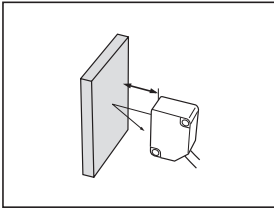

## Procedure for setting up positioning

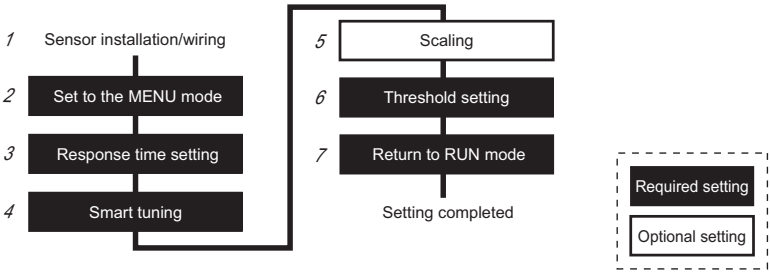

### 1 Sensor installation/wiring **Required**

Has the Sensor been installed and wired? (See page 23.)







Set the sensing object in place, adjust the position of the Sensor Head while looking at the digital display values on the Amplifier Unit or the indicators on the Sensor Head so that the upper and lower limits of the distance between the Sensor Head and the sensing object is within the measurement range, and install the Sensor Head at this position.

### 2 Set to the MENU mode **Required**

Select the desired mode to set the measurement conditions in.











Button Operation	Display	Description of Operation	Explanation of Selection Menu
<p>Hold down for 3 seconds</p>		Hold down the  button for three seconds to switch to the MENU mode.	
<p>Press to display</p>		Press the  button to display <i>DETAIL</i> .	* This operation is not required when scaling is not to be set.



Button Operation	Display	Description of Operation	Explanation of Selection Menu
 Press to display.		Press the  button to set the display to <b>ON</b> to set display of the detail menu.	
SMART  MENU/SET 		Press the  button to apply the setting.	

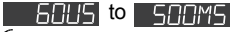

### 3 Response time setting **Required**

Select the response time to match the size and moving speed of the sensing object.

Button Operation	Display	Description of Operation	Explanation of Selection Menu
 Press to display.		Press the  button to display <b>SPEED</b> .	Default value: 500 ms
 Press to select	 Select the desired value.	Press the  button to select the response time.	Select the response time to match the size and moving speed of the sensing object.  { 60 $\mu$ s, 120 $\mu$ s, 240 $\mu$ s, 500 $\mu$ s, 1 ms, 2 ms, 4 ms, 8 ms, 12 ms, 20 ms, 36 ms, 66 ms, 128 ms, 250 ms, 500 ms }
SMART  MENU/SET 		Press the  button to apply the setting.	* After the response time is changed, the smart tuning results are cleared, so be sure to re-execute tuning.

## 4 Smart tuning **Required**

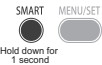







Smart tuning sets optimum sensing conditions according to the operating conditions (response time and color/state of workpiece)













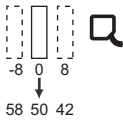
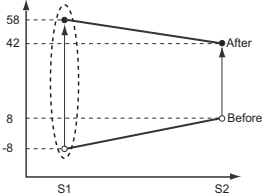











Button Operation	Display	Description of Operation	Explanation of Selection Menu
—	—	Check that the reference workpiece is set in place.	
	 <p>Pressing down</p> <p>↓</p> <p>Pressed down</p> <p>Flashing</p>	Press the  button for one second. When <i>SMART SINGLE</i> is displayed, release your finger from the button to start execution of smart tuning.	if " <b>FAILED</b> " flashes on the sub-display for three seconds, it indicates that tuning was not possible. Change the response time setting to a larger value, and try again.

\* To tune multiple workpieces or to tune workpieces having a different surface condition: **page 78**

## 5 Scaling **Optional**

Set this item to change the display scale when you want to display a digital value on the Amplifier Unit different from the actual measured value. (e.g. to display the actual sensing distance)

Button Operation	Display	Description of Operation	Explanation of Selection Menu
		Press the  button to display <i>SCALE</i> .	Default value: OFF
		Press the  button to display <i>ON</i> .	
 		Press the  button to enable setting of scaling.	

Button Operation	Display	Description of Operation	Explanation of Selection Menu
		Press the  button to display S1-bEF.	<p>&lt;To display the actual sensing distance&gt;</p>   <p>* If the  button is pressed when the cursor is at the right-most digit or the  button is pressed when the cursor is at the left-most digit, the setting will be canceled.</p>
		Press the  button to enable setting of S1-Before.	
[Change numeric value] [Move digit] 	 [Numeric value before change] Set any value.	Press the  button to move the digit, press the  button to change the numeric value, and set the measured value before S1 is changed.	
SMART MENU/SET 		Press the  button to apply the numeric value of S1-Before.	
		Press the  button to display S1-AFT.	
		Press the  button to enable setting of S1-After.	
[Change numeric value] [Move digit] 	 [Numeric value after change] Set any value.	Press the  button to move the digit, press the  button to change the numeric value, and set the measured value after S1 is changed.	
SMART MENU/SET 		Press the  button to apply the numeric value of S1-After.	

CONTENTS

INTRODUCTION

PREPARATION FOR MEASUREMENT

FLOW OF OPERATION

BASIC SETUP

MAIN APPLICATIONS &amp; SETTING METHODS

Height

Steps and Warpage

Double Sheet Detection

Thickness

Positioning

Eccentricity and Surface Deflection

DETAILED SETTINGS













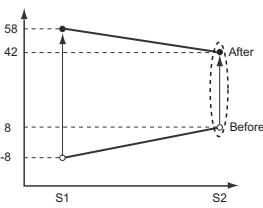



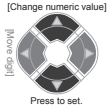



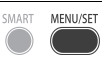

TROUBLE-SHOOTING

SPECIFICATIONS

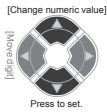
INDEX













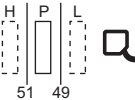











SETTING TRANSITION CHARTS

- CONTENTS
- INTRODUCTION
- PREPARATION FOR MEASUREMENT
- FLOW OF OPERATION
- BASIC SETUP
- MAIN APPLICATIONS & SETTING METHODS
- Height
- Steps and Warpage
- Double Sheet Detection
- Thickness
- Positioning
- Eccentricity and Surface Deflection
- DETAILED SETTINGS
- TROUBLE-SHOOTING
- SPECIFICATIONS
- INDEX
- SETTING TRANSITION CHARTS

Button Operation	Display	Description of Operation	Explanation of Selection Menu
 Press to display		Press the  button to display 52-bEF.	 <p>* If the  button is pressed when the cursor is at the right-most digit or the  button is pressed when the cursor is at the left-most digit, the setting will be canceled.</p>
		Press the  button to enable setting of S2-Before.	
	 [Numeric value before change] Set any value.	Press the  button to move the digit, press the  button to change the numeric value, and set the measured value before S2 is changed.	
		Press the  button to apply the numeric value of S2-Before.	
 Press to display		Press the  button to display 52-AFT.	
		Press the  button to enable setting of S2-After.	
	 [Numeric value after change] Set any value.	Press the  button to move the digit, press the  button to change the numeric value, and set the measured value after S2 is changed.	
		Press the  button to apply the numeric value of S2-After.	



## 6 Threshold Setting **Required**

Set the range of measured values to be judged as PASS by setting the HIGH and LOW thresholds.

Button Operation	Display	Description of Operation	Explanation of Selection Menu
 Press to display.		Press the  button to display the HIGH threshold.	Setting example: Non-defective product position 49 to 51 mm 
		Press the  button to enable setting of the HIGH threshold.	
[Change numeric value]  Press to set.		Press the  button to move the digit, press the  button to change the numeric value, and set the HIGH threshold.	Set the positioning MAX and MIN distances to the HIGH and LOW thresholds, respectively.
		Press the  button to apply the setting.	
 Press to display.		Press the  button to display the LOW threshold.	* If the  button is pressed when the cursor is at the right-most digit or the  button is pressed when the cursor is at the left-most digit, the setting will be canceled.
		Press the  button to enable setting of the LOW threshold.	
[Change numeric value]  Press to set.		Press the  button to move the digit, press the  button to change the numeric value, and set the LOW threshold.	* Set so that the HIGH threshold is greater than the LOW threshold.
		Press the  button to apply the setting.	

## 7 Return to RUN mode **Required**

Switch to the mode in which measurement is performed.

Button Operation	Display	Description of Operation	Explanation of Selection Menu
 Hold down for 3 seconds		Hold down the  button for three seconds to switch to the RUN mode.	

\* For details on optimizing settings, such as output and input, see "DETAILED SETTINGS."

CONTENTS

INTRODUCTION

PREPARATION FOR MEASUREMENT

FLOW OF OPERATION

BASIC SETUP

MAIN APPLICATIONS & SETTING METHODS

Height

Steps and Warpage

Double Sheet Detection

Thickness

Positioning

Eccentricity and Surface Deflection

DETAILED SETTINGS

TROUBLE-SHOOTING

SPECIFICATIONS

INDEX

SETTING TRANSITION CHARTS

# Eccentricity and Surface Deflection

- CONTENTS
- INTRODUCTION
- PREPARATION FOR MEASUREMENT
- FLOW OF OPERATION
- BASIC SETUP
- MAIN APPLICATIONS & SETTING METHODS
- Height
- Steps and Warpage
- Double Sheet Detection
- Thickness
- Positioning
- Eccentricity and Surface Deflection
- DETAILED SETTINGS
- TROUBLE-SHOOTING
- SPECIFICATIONS
- INDEX
- SETTING TRANSITION CHARTS

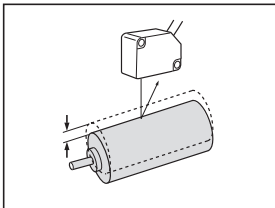

## Procedure for setting up eccentricity and surface deflection

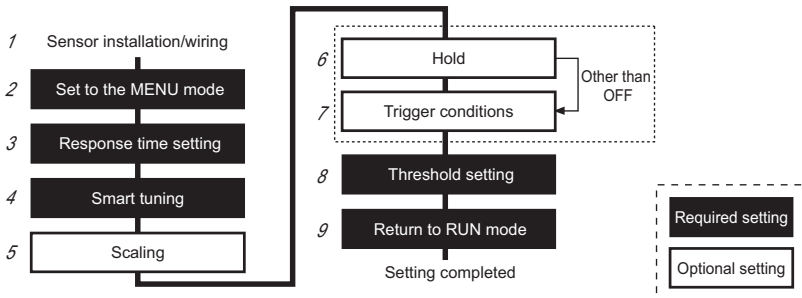

### 1 Sensor installation/wiring **Required**



Has the Sensor been installed and wired? (See page 23.)

Set the sensing object in place, adjust the position of the Sensor Head while looking at the digital display values on the Amplifier Unit or the indicators on the Sensor Head so that the clearance between the Sensor Head and the sensing object is near the measurement center distance, and install the Sensor Head at this position.

### 2 Set to the MENU mode **Required**











Select the desired mode to set the measurement conditions in.

Button Operation	Display	Description of Operation	Explanation of Selection Menu
 Hold down for 3 seconds		Hold down the  button for three seconds to switch to the MENU mode.	
		Press the  button to display <b>DETAIL L</b> .	* This operation is not required when scaling, hold and trigger conditions are not to be set.
 Press to display.		Press the  button to set the display to <b>ON</b> to set display of the detail menu.	

Button Operation	Display	Description of Operation	Explanation of Selection Menu
 		Press the  button to apply the setting.	

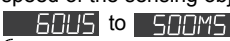



### 3 Response time setting **Required**

Select the response time to match the size and moving speed of the sensing object.

Button Operation	Display	Description of Operation	Explanation of Selection Menu
 Press to display		Press the  button to display <i>SPEED</i> .	<div style="border: 1px solid black; padding: 5px; display: inline-block;">Default value: 500 ms</div>
 Press to select	 Select the desired value.	Press the  button to select the response time.	Select the response time to match the size and moving speed of the sensing object. <div style="border: 1px solid black; padding: 5px; display: inline-block;">  </div> <div style="border: 1px solid black; padding: 5px; display: inline-block;">           60 <math>\mu</math>s, 120 <math>\mu</math>s, 240 <math>\mu</math>s, 500 <math>\mu</math>s, 1 ms, 2 ms, 4 ms, 8 ms, 12 ms, 20 ms, 36 ms, 66 ms, 128 ms, 250 ms, 500 ms         </div>
 		Press the  button to apply the setting.	* After the response time is changed, the smart tuning results are cleared, so be sure to re-execute tuning.

### 4 Smart tuning **Required**

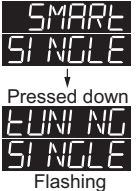
Smart tuning sets optimum sensing conditions according to the operating conditions (response time and color/state of workpiece)

Button Operation	Display	Description of Operation	Explanation of Selection Menu
—	—	Check that the reference workpiece is set in place.	
  Hold down for 1 second	 Pressing down <i>SMART SINGLE</i> ↓ Pressed down <i>TUNING SINGLE</i> Flashing	Press the  button for one second. When <i>SMART SINGLE</i> is displayed, release your finger from the button to start execution of smart tuning.	<div style="border: 1px dashed black; padding: 5px;">           If "<i>FAILED</i>" flashes on the sub-display for three seconds, it indicates that tuning was not possible. Change the response time setting to a larger value, and try again.         </div>

\* To tune multiple workpieces or to tune workpieces having a different surface condition: **page 78**

CONTENTS

INTRODUCTION

PREPARATION FOR MEASUREMENT

FLOW OF OPERATION

BASIC SETUP

MAIN APPLICATIONS & SETTING METHODS

Height

Steps and Warpage

Double Sheet Detection

Thickness

Positioning

Eccentricity and Surface Deflection

DETAILED SETTINGS

TROUBLE-SHOOTING





















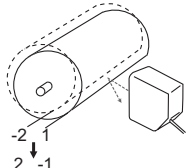
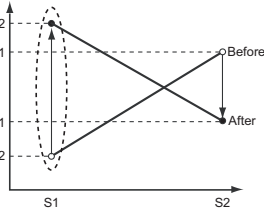







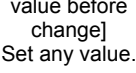

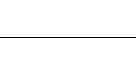

SPECIFICATIONS

INDEX



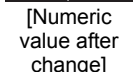



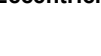





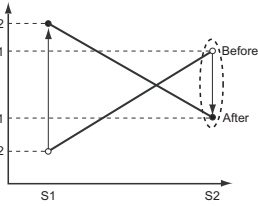













SETTING TRANSITION CHARTS

# 5 Scaling Optional

Set this item to change the display scale when you want to display a digital value on the Amplifier Unit different from the actual measured value. (e.g. to reverse the - and + indications)



CONTENTS	Button Operation	Display	Description of Operation	Explanation of Selection Menu
INTRODUCTION	 Press to display		Press the  button to display <i>SCALE</i> .	Default value: OFF
PREPARATION FOR MEASUREMENT	 Press to display.		Press the  button to display <i>ON</i> .	
FLOW OF OPERATION			Press the  button to enable setting of scaling.	
BASIC SETUP	 Press to display		Press the  button to display <i>S1-BEF</i> .	<p>To set the NEAR and FAR sides as - and + indications to the sensor:</p>  <p style="text-align: center;">-2 1 ↓ 2 -1</p>  <p style="text-align: center;">S1 S2</p> <p>* If the  button is pressed when the cursor is at the right-most digit or the  button is pressed when the cursor is at the left-most digit, the setting will be canceled.</p>
MAIN APPLICATIONS & SETTING METHODS			Press the  button to enable setting of S1-Before.	
Height			Press the  button to enable setting of S1-Before.	
Steps and Warpage	 [Change numeric value]	 [Numeric value before change] Set any value.	Press the  button to move the digit, press the  button to change the numeric value, and set the measured value before S1 is changed.	
Double Sheet Detection	 Press to set.		Press the  button to apply the numeric value of S1-Before.	
Thickness	 Press to display		Press the  button to display <i>S1-AFT</i> .	
Positioning			Press the  button to enable setting of S1-After.	
Eccentricity and Surface Deflection	 [Change numeric value]	 [Numeric value after change] Set any value.	Press the  button to move the digit, press the  button to change the numeric value, and set the measured value after S1 is changed.	
DETAILED SETTINGS			Press the  button to apply the numeric value of S1-After.	
TROUBLE-SHOOTING				
SPECIFICATIONS				
INDEX				
SETTING TRANSITION CHARTS				



Button Operation	Display	Description of Operation	Explanation of Selection Menu
 Press to display		Press the  button to display <i>S2-BEF</i> .	 <p>* If the  button is pressed when the cursor is at the right-most digit or the  button is pressed when the cursor is at the left-most digit, the setting will be canceled.</p>
		Press the  button to enable setting of S2-Before.	
[Change numeric value] [Move digit]  Press to set.	 [Numeric value before change] Set any value.	Press the  button to move the digit, press the  button to change the numeric value, and set the measured value before S2 is changed.	
SMART MENU/SET  		Press the  button to apply the numeric value of S2-Before.	
 Press to display		Press the  button to display <i>S2-AFT</i> .	
		Press the  button to enable setting of S2-After.	
[Change numeric value] [Move digit]  Press to set.	 [Numeric value after change] Set any value.	Press the  button to move the digit, press the  button to change the numeric value, and set the measured value after S2 is changed.	
SMART MENU/SET  		Press the  button to apply the numeric value of S2-After.	

## 6 Hold Optional

Set this item to hold measured values during the measurement period according to preset hold conditions.

Button Operation	Display	Description of Operation	Explanation of Selection Menu
 Press to display		Press the  button to display <i>HOLD</i> .	Default value: OFF

CONTENTS

INTRODUCTION

PREPARATION FOR MEASUREMENT

FLOW OF OPERATION

BASIC SETUP

MAIN APPLICATIONS &amp; SETTING METHODS

Height

Steps and Warpage

Double Sheet Detection

Thickness

Positioning

Eccentricity and Surface Deflection

DETAILED SETTINGS











TROUBLE-SHOOTING

SPECIFICATIONS

INDEX



SETTING TRANSITION CHARTS



















- CONTENTS
- INTRODUCTION
- PREPARATION FOR MEASUREMENT
- FLOW OF OPERATION
- BASIC SETUP
- MAIN APPLICATIONS & SETTING METHODS
- Height
- Steps and Warpage
- Double Sheet Detection
- Thickness
- Positioning
- Eccentricity and Surface Deflection
- DETAILED SETTINGS
- TROUBLE-SHOOTING
- SPECIFICATIONS
- INDEX
- SETTING TRANSITION CHARTS

Button Operation	Display	Description of Operation	Explanation of Selection Menu
	 <p>Select the desired value.</p>	<p>Press the  button to select the hold conditions.</p>	<p> OFF</p> <p>Hold OFF</p> <p> AVE</p> <p>The average measured value during the sampling period is held.</p> <p> PEP</p> <p>The difference between the minimum and maximum values during the sampling period is held.</p> <p> SAMPLE</p> <p>The measured value at the start of the sampling period is held.</p> <p> BOTTOM</p> <p>The minimum value during the sampling period is held.</p> <p> PEAK</p> <p>The maximum value during the sampling period is held. <b>(For details, see page 91.)</b></p>
<p>SMART MENU/SET</p> 		<p>Press the  button to apply the setting.</p> <p>(When other than OFF is selected, proceed to "7 Trigger conditions," and when OFF is selected, proceed to "8 Threshold setting.")</p>	<p>* The clamp value is output until the first sampling period is finished. <b>(For details on the clamp value, see page 107.)</b></p>

## 7 Trigger conditions Optional

Set how timing of the hold measurement period is to be input.

Button Operation	Display	Description of Operation	Explanation of Selection Menu
		<p>Press the  button to display TRIG.</p>	<div style="border: 1px solid black; padding: 5px; display: inline-block;">Default value: TIMING</div>

Button Operation	Display	Description of Operation	Explanation of Selection Menu
 <p>Press to select</p>	 <p>Select the desired value.</p>	Press the  button to select the trigger conditions.	<p><b>E1 MI NG</b></p> <p>Enter the trigger by using the timing input or by pressing the  button in the RUN mode. The period that the timing signal is ON is the sampling period.</p> <p><b>SELF-d</b></p> <p>The sampling period is the period that the measured value is lower than the specified self-trigger level.</p> <p><b>SELF-U</b></p> <p>The sampling period is the period that the measured value is greater than the specified self-trigger level.  <b>(For details, see page 93.)</b></p>
<p>SMART MENU/SET</p> 		Press the  button to apply the trigger conditions.	
		<p>(When <b>SELF-U</b> and <b>SELF-d</b> are selected, proceed to the next item, and when <b>E1 MI NG</b> is selected, proceed to "8 Threshold setting.")</p>	
 <p>Press to display</p>		Press the  button to display <b>SELF LV</b> .	<div style="border: 1px solid black; padding: 2px;">Default value: 0.000</div>
		Press the  button to enable setting of the self-trigger level.	
<p>[Change numeric value] [Move digit]</p>  <p>Press to set.</p>	 <p>Set any value.</p>	Press the  button to move the digit, press the  button to change the numeric value, and set the self-trigger level.	<p>* If the  button is pressed when the cursor is at the right-most digit or the  button is pressed when the cursor is at the left-most digit, the setting will be canceled.</p>
<p>SMART MENU/SET</p> 		Press the  button to apply the setting.	

CONTENTS

INTRODUCTION

PREPARATION FOR MEASUREMENT

FLOW OF OPERATION

BASIC SETUP

MAIN APPLICATIONS &amp; SETTING METHODS

Height

Steps and Warpage

Double Sheet Detection

Thickness

Positioning

Eccentricity and Surface Deflection

DETAILED SETTINGS

TROUBLE-SHOOTING















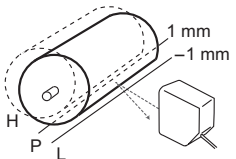















SPECIFICATIONS

INDEX

SETTING TRANSITION CHARTS

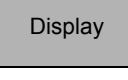

## 8 Threshold Setting **Required**

Set the range of measured values to be judged as **PASS** by setting the **HIGH** and **LOW** thresholds.

CONTENTS	Button Operation	Display	Description of Operation	Explanation of Selection Menu
INTRODUCTION	 Press to display.		Press the  button to display the <b>HIGH</b> threshold.	Setting example: Non-defective product eccentricity -1 to 1 mm
PREPARATION FOR MEASUREMENT			Press the  button to enable setting of the <b>HIGH</b> threshold.	
FLOW OF OPERATION	 [Change numeric value] [Move digit] Press to set.		Press the  button to move the digit, press the  button to change the numeric value, and set the <b>HIGH</b> threshold. Set any value.	
BASIC SETUP			Press the  button to apply the setting.	Set the eccentricity <b>MAX</b> and <b>MIN</b> distances to be regarded as <b>OK</b> to the <b>HIGH</b> and <b>LOW</b> thresholds, respectively.  * If the  button is pressed when the cursor is at the right-most digit or the  button is pressed when the cursor is at the left-most digit, the setting will be canceled.  * Set so that the <b>HIGH</b> threshold is greater than the <b>LOW</b> threshold.
MAIN APPLICATIONS & SETTING METHODS	 Press to display.		Press the  button to display the <b>LOW</b> threshold.	
Height			Press the  button to enable setting of the <b>LOW</b> threshold.	
Steps and Warpage	 [Change numeric value] [Move digit] Press to set.		Press the  button to move the digit, press the  button to change the numeric value, and set the <b>LOW</b> threshold. Set any value.	
Double Sheet Detection			Press the  button to apply the setting.	
Thickness			Press the  button to display the <b>LOW</b> threshold.	
Positioning	 [Change numeric value] [Move digit] Press to set.		Press the  button to move the digit, press the  button to change the numeric value, and set the <b>LOW</b> threshold. Set any value.	
Eccentricity and Surface Deflection			Press the  button to apply the setting.	

## 9 Return to RUN mode **Required**

Switch to the mode in which measurement is performed.

CONTENTS	Button Operation	Display	Description of Operation	Explanation of Selection Menu
TROUBLE-SHOOTING	 HOLD down for 3 seconds		Hold down the  button for three seconds to switch to the <b>RUN</b> mode.	
SPECIFICATIONS				
INDEX				

\* For details on optimizing settings, such as output and input, see "DETAILED SETTINGS."

# DETAILED SETTINGS

<b>Smart Tuning</b> (Optimizing the Sensing Conditions)	<b>78</b>
<b>Connecting Two or More Amplifier Units</b>	<b>82</b>
<b>Mutual Interference Prevention</b>	<b>84</b>
<b>Setting the Hysteresis</b> (Improving Unstable Measurement Near the Judgement Threshold)	<b>87</b>
<b>Setting the Hold Function</b> (Holding Measured Values Under Special Conditions)	<b>89</b>
<b>Bank Setting</b>	<b>95</b>
<b>Zero Reset</b>	<b>97</b>
<b>Scaling</b> (Changing Digital Values for Specific Measured Values)	<b>101</b>
<b>Analog Output</b>	<b>105</b>
<b>Output for Non-measurement</b> (Output Setting During Input of the Reset Signal at an Error)	<b>107</b>
<b>Timer</b>	<b>110</b>
<b>Setting the Differential Function</b>	<b>112</b>
<b>External Input for Bank, Timing Input, Reset Input</b>	<b>114</b>
<b>Setting the Detection Surface Selection</b> (Decreasing Incorrect Measurement Caused by Multireflection on Workpiece)	<b>116</b>
<b>Key Lock Function</b>	<b>118</b>
<b>Initializing Settings Data</b>	<b>119</b>

# Smart Tuning

Setting channels used when connecting multiple units  
 If mutual interference prevention is ON: CH1  
 If mutual interference prevention is set to OFF: Each CH

## Smart tuning:

This setting option sets optimum sensing conditions according to the operating conditions (response time and color/state of workpiece).

### Procedure for setting up smart tuning

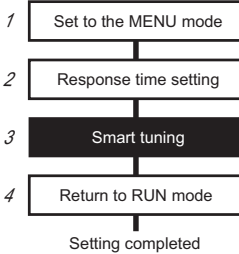

\* Steps 1, 2 and 4 are not required when the response time setting is completed since smart tuning can be performed even in the RUN mode.

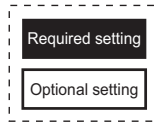

### Important

- When connecting two or more Amplifier Units and mutual interference prevention is set to ON, use the CH1 Amplifier Unit to execute tuning. After smart tuning execution for CH1 ends, it is also executed for the Amplifier Units of CH2 and later.
- If the tuning result is NG for either Amplifier Unit, the smart tuning setup results are not applied to any amplifier units.







## 1 Set to the MENU mode Optional

Button Operation	Display	Description of Operation	Explanation of Selection Menu
		Hold down the  button for three seconds to switch to the MENU mode.	

## 2 Response time setting Optional

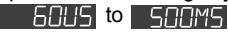
Button Operation	Display	Description of Operation	Explanation of Selection Menu
		Press the  button to display <i>SPEED</i> .	Default value: 500 ms

CONTENTS
INTRODUCTION
PREPARATION FOR MEASUREMENT
FLOW OF OPERATION
BASIC SETUP
MAIN APPLICATIONS & SETTING METHODS
Height
Steps and Warpage
Double Sheet Detection
Thickness
Positioning
Eccentricity and Surface Deflection
DETAILED SETTINGS
TROUBLE-SHOOTING
SPECIFICATIONS
INDEX
SETTING TRANSITION CHARTS





Button Operation	Display	Description of Operation	Explanation of Selection Menu
 Press to select	 Select the desired value.	Press the  button to select the response time.	Select the response time to match the size and moving speed of the sensing object.  { 60 $\mu$ s, 120 $\mu$ s, 240 $\mu$ s, 500 $\mu$ s, 1 ms, 2 ms, 4 ms, 8 ms, 12 ms, 20 ms, 36 ms, 66 ms, 128 ms, 250 ms, 500 ms }
 		Press the  button to apply the setting.	* After the response time is changed, the smart tuning results are cleared, so be sure to re-execute tuning.

### 3 Smart tuning **Required**









Select from one of the following three methods to execute smart tuning:

- (1) Tuning of a single stationary workpiece: Single smart tuning
- (2) Tuning of multiple stationary workpieces: Multi-smart tuning (a mix of workpieces having different color and state)
- (3) Tuning of workpieces having different surface states: Active smart tuning (execution of tuning while workpieces are moving)

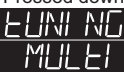
#### (1) Tuning of a single stationary workpiece: Single smart tuning

Button Operation	Display	Description of Operation	Explanation of Selection Menu
—	—	Set the reference workpiece in place.	
  Hold down for 1 second	 ↓  Flashing	Press the  button for one second. When <i>SMART/ SINGLE</i> is displayed, release your finger from the button to start execution of smart tuning.	If " <b>FAILED</b> " flashes on the sub-display for three seconds, it indicates that tuning was not possible. Change the response time setting to a larger value, and try again.

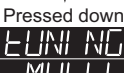





**(2) Tuning of multiple stationary workpieces: Multi-smart tuning  
(a mix of workpieces having different color and state)**

Button Operation	Display	Description of Operation	Explanation of Selection Menu
—	—	Set reference workpiece 1 in place.	
  Hold down for 3 seconds	Pressing down  ↓ Pressed down  Flashing	Press the  button for three seconds. When <i>SMART / MULE1</i> is displayed, release your finger from the button to start execution of smart tuning.	* <i>SMART / SINGLE</i> is displayed for one to three seconds after the button is pressed, and then <i>SMART / MULE1</i> is displayed. If " <b>FAILED</b> " flashes on the sub-display for three seconds, it indicates that tuning was not possible. Change the response time setting to a larger value, and try again.
—	—	Swap the workpiece with reference workpiece 2 and set it in place.	
  Hold down for 3 seconds	Pressing down  ↓ Pressed down  Flashing	Press the  button for three seconds. When <i>SMART / MULE1</i> is displayed, release your finger from the button to start execution of smart tuning.	The optimum conditions are set for either reference workpiece 1 or 2 is set. * <i>SMART / SINGLE</i> is displayed for one to three seconds after the button is pressed, and then <i>SMART / MULE1</i> is displayed. If you release your finger from the button <i>SMART / SINGLE</i> , the result of tuning workpiece 1 will not be reflected. If " <b>FAILED</b> " flashes on the sub-display for three seconds, it indicates that tuning was not possible. Change the response time setting to a larger value, and try again.



When there are three or more reference workpieces, swap each workpiece and repeat the procedure.

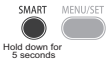

### (3) Tuning of workpieces having different surface states: Active smart tuning (execution of tuning while workpieces are moving)

Button Operation	Display	Description of Operation	Explanation of Selection Menu
 <p>Hold down for 5 seconds</p>	<p>Pressing down</p>  <p>↓</p> <p>Pressed down</p>  <p>Flashing</p>	<p>Press the  button for five seconds with the workpiece set in place. When <i>SMART/ACTIVE</i> is displayed, release your finger from the button to start execution of smart tuning.</p> <p>Because the execution of smart tuning continues, move the workpiece.</p>	<p>* <i>SMART/ISINGLE</i> and <i>SMART/MULTI</i> are displayed for one to five seconds after the button is pressed, and then <i>SMART/ACTIVE</i> is displayed.</p>
 <p>Hold down for 5 seconds</p>		<p>At the end of the desired tuning period, press the  button again for 5 to end tuning.</p>	<p>The optimum setting conditions will be set.</p> <p>If "<b>FAILED</b>" flashes on the sub-display for three seconds, it indicates that tuning was not possible. Change the response time setting to a larger value, and try again.</p>

## 4 Return to RUN mode Optional

Button Operation	Display	Description of Operation	Explanation of Selection Menu
 <p>Hold down for 3 seconds</p>		<p>Hold down the  button for three seconds to switch to the RUN mode.</p>	

CONTENTS

INTRODUCTION

PREPARATION FOR MEASUREMENT

FLOW OF OPERATION

BASIC SETUP

MAIN APPLICATIONS &amp; SETTING METHODS

Height

Steps and Warpage

Double Sheet Detection

Thickness

Positioning

Eccentricity and Surface Deflection

DETAILED SETTINGS

TROUBLE-SHOOTING

SPECIFICATIONS

INDEX

SETTING TRANSITION CHARTS

# Connecting Two or More Amplifier Units

Use a Calculating Unit to connect Amplifier Units when performing calculations between Amplifier Units and to prevent mutual interference between Sensor Heads.

The number of Amplifier Units that can be connected differs depending on the functions to be used.

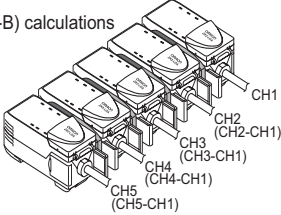
Function	Number of Connectable Amplifier Units	See:
Calculation	Up to two units (Up to five units can be connected. However, calculations are done between pairs of two.)  For (A-B) calculations 	(A-B) calculation: Page 45 Thickness calculation: Page 55
Mutual interference prevention	Up to five units	Page 84

## Important

- Supply power to all connected Amplifier Units at the same time.
- When connecting two or more Amplifier Units, the response times (maximum values) are as follows:

Mutual Interference Prevention	Two-Sensor Operation	Total Response Time
OFF	OFF	Response time setting for each CH
	(A - B), THICK	(Total response time setting for each CH) + (4 ms × number of connected units)
ON	OFF	(Response time per unit in the table below) × number of connected units
	(A - B), THICK	

<Response time if mutual interference prevention is set to ON>

CH1 Response Time Setting	Response Time per Unit
60 μs	3 ms
120 μs	3 ms
240 μs	3 ms
500 μs	4 ms
1 ms	8 ms
2 ms	16 ms
4 ms	32 ms
8 ms	64 ms
12 ms	72 ms
20 ms	80 ms
36 ms	100 ms
66 ms	160 ms
128 ms	280 ms
250 ms	520 ms
500 ms	1 s

The displayed and set up menus differ depending on the channel when two or more Amplifier Units are connected and when mutual interference prevention is set to ON.

Use the Amplifier Units of the corresponding channel numbers to specify settings by referring to the tables below.

<Menus and setting channels when two or more Amplifier Units are connected>

Menu	CHs Used to Specify Settings	CHs Not Used to Specify Settings	Notes
Mutual interference prevention <i>SYNC</i>	CH1	CH2 to CH5: These cannot be used. (The setting menu is not displayed on the digital display.)	The setting of CH1 is also applied to Amplifier Units of CH2 and later.
Two-sensor operation setting <i>SCALE</i> Thickness setting <i>THICK</i>	CH2 to CH5	CH1: This cannot be used. (The setting menu is not displayed on the digital display.)	
Bank switching setting <i>BANK</i>	CH1	CH2 to CH5: These cannot be used. (The setting menu is not displayed on the digital display.)	<ul style="list-style-type: none"> <li>The Amplifier Units of CH2 and later are switched together with CH1. (Bank registration is possible for individual amplifier units.)</li> <li>Also use CH1 to switch the banks by means of an external input.</li> </ul>
Initialization <i>INIT</i>	CH1	CH2 to CH5: These cannot be used. (The setting menu is not displayed on the digital display.)	The Amplifier Units of CH2 and later are initialized together with CH1.

<Menus and setting channels when mutual interference prevention is set to ON>

Menu	CHs Used to Specify Settings	CHs Not Used to Specify Settings	Notes
Response time setting <i>SPEED</i>	CH1	CH2 to CH5: These cannot be used. (The setting menu is not displayed on the digital display.)	The setting of CH1 is also applied to Amplifier Units of CH2 and later.
Smart tuning	CH1	CH2 to CH5: Smart tuning cannot be executed for these separately.	Smart tuning for the Amplifier Units of CH2 and later are executed together with CH1.

(For details on the setup procedure when mutual interference prevention is set to ON, see the next page.)

Mutual interference prevention:

This refers to the function for preventing the influence of Sensor Heads when mounted close to each other. (This function can be used for up to five Amplifier Units connected by using Calculating Units (ZX2-CAL).)

## Procedure for setting up mutual interference prevention

- 1 Set to the MENU mode
  - 2 Mutual interference prevention setting
  - 3 Return to RUN mode
- Setting completed

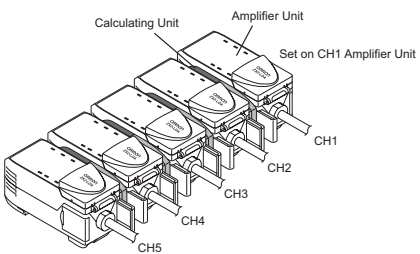









### 1 Set to the MENU mode





Button Operation	Display	Description of Operation	Explanation of Selection Menu
<p>Hold down for 3 seconds</p>		Hold down the  button of the CH1 Amplifier Unit for three seconds to switch to the MENU mode.	
		Press the  button to display <i>DETAIL L</i> .	* This step is not required if detail menu display is already set to ON in the MENU mode.
		Press the  button to set the display to <i>ON</i> to set display of the detail menu.	
		Press the  button to apply the setting.	

- CONTENTS
- INTRODUCTION
- PREPARATION FOR MEASUREMENT
- FLOW OF OPERATION
- BASIC SETUP
- MAIN APPLICATIONS & SETTING METHODS
- Height
- Steps and Warpage
- Double Sheet Detection
- Thickness
- Positioning
- Eccentricity and Surface Deflection
- DETAILED SETTINGS
- TROUBLE-SHOOTING
- SPECIFICATIONS
- INDEX
- SETTING TRANSITION CHARTS

## 2 Mutual interference prevention setting

Button Operation	Display	Description of Operation	Explanation of Selection Menu
 Press to display		Press the  button to display SYNC.	Default value: OFF
 Press to display.		Press the  button to display ON.	
 MENU/SET 		Press the  button to apply the setting.	

## 3 Return to RUN mode

Button Operation	Display	Description of Operation	Explanation of Selection Menu
 MENU/SET  Hold down for 3 seconds		Hold down the  button for three seconds to switch to the RUN mode.	

### Important

- When CH1 is used to specify a setting while mutual interference prevention is set to ON, the menus for which the same setting is applied to the Amplifier Units of CH2 and later are shown in the following table.

Specify settings for the menus in the following table after setting mutual interference prevention to ON.

Menu	Displayable and Specifiable CH Number	Notes
Response time setting <i>SPEED</i>	CH1	The setting of CH1 is also applied to Amplifier Units of CH2 and later.
Smart tuning	CH1	Smart tuning for the Amplifier Units of CH2 and later are executed together with CH1.

- When connecting two or more Amplifier Units, the response times (maximum values) are as follows:

Mutual Interference Prevention	Two-Sensor Operation	Total Response Time
OFF	OFF	Response time setting for each CH
	(A – B), THICK	(Total response time setting for each CH) + (4 ms × number of connected units)
ON	OFF	(Response time per unit in the table below) × number of connected units
	(A – B), THICK	

CONTENTS

INTRODUCTION

PREPARATION FOR MEASUREMENT

FLOW OF OPERATION

BASIC SETUP

MAIN APPLICATIONS &amp; SETTING METHODS

Height

Steps and Warpage

Double Sheet Detection

Thickness

Positioning

Eccentricity and Surface Deflection

DETAILED SETTINGS

TROUBLE-SHOOTING

SPECIFICATIONS

INDEX

SETTING TRANSITION CHARTS

<Response time if mutual interference prevention is set to ON>

CH1 Response Time Setting	Response Time per Unit
60 $\mu$ s	3 ms
120 $\mu$ s	3 ms
240 $\mu$ s	3 ms
500 $\mu$ s	4 ms
1 ms	8 ms
2 ms	16 ms
4 ms	32 ms
8 ms	64 ms
12 ms	72 ms
20 ms	80 ms
36 ms	100 ms
66 ms	160 ms
128 ms	280 ms
250 ms	520 ms
500 ms	1 s

- CONTENTS**
- INTRODUCTION
- PREPARATION FOR MEASUREMENT
- FLOW OF OPERATION
- BASIC SETUP**
- MAIN APPLICATIONS & SETTING METHODS
- Height
- Steps and Warpage
- Double Sheet Detection
- Thickness
- Positioning
- Eccentricity and Surface Deflection
- DETAILED SETTINGS**
- TROUBLE-SHOOTING
- SPECIFICATIONS
- INDEX
- SETTING TRANSITION CHARTS

# Setting the Hysteresis

Setting channels used when connecting multiple units: Each CH

Hysteresis width:

This refers to the difference between the operation point and return point. Set the hysteresis width for the upper and lower limits of the judgements if the HIGH, PASS or LOW judgement is unstable near the threshold values.

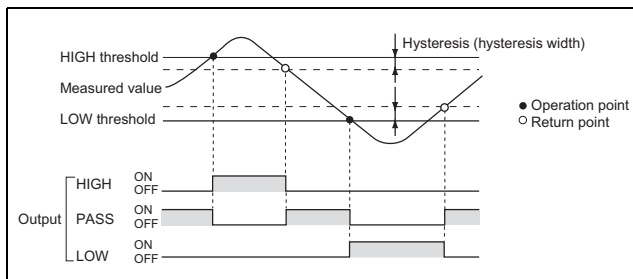

## Procedure for setting up the hysteresis width

- 1 Set to the MENU mode
  - 2 Hysteresis width setting
  - 3 Return to RUN mode
- Setting completed

### 1 Set to the MENU mode

Button Operation	Display	Description of Operation	Explanation of Selection Menu
 Hold down for 3 seconds		Hold down the  button for three seconds to switch to the MENU mode.	
 Press to display		Press the  button to display dETAIL L.	* This step is not required if detail menu display is already set to ON in the MENU mode.
 Press to display.		Press the  button to set the display to ON to set display of the detail menu.	
		Press the  button to apply the setting.	

CONTENTS

INTRODUCTION

PREPARATION FOR MEASUREMENT

FLOW OF OPERATION

BASIC SETUP

MAIN APPLICATIONS & SETTING METHODS

Height

Steps and Warpage

Double Sheet Detection

Thickness

Positioning

Eccentricity and Surface Deflection

DETAILED SETTINGS













TROUBLE-SHOOTING

SPECIFICATIONS



INDEX

SETTING TRANSITION CHARTS

## 2 Hysteresis width setting

Button Operation	Display	Description of Operation	Explanation of Selection Menu
 Press to display		Press the  button to display HYS.	Default value: 0.000
 Press to display.		Press the  button to enable setting of the hysteresis width.	
[Change numeric value] [Move digit]  Press to set.	 Set any value.	Press the  button to move the digit, press the  button to change the numeric value, and set the hysteresis width.	* If the  button is pressed when the cursor is at the right-most digit or the  button is pressed when the cursor is at the left-most digit, the setting will be canceled.
 MENU/SET		Press the  button to apply the setting.	

## 3 Return to RUN mode

Button Operation	Display	Description of Operation	Explanation of Selection Menu
 MENU/SET Hold down for 3 seconds		Hold down the  button for three seconds to switch to the RUN mode.	

### Important

- The hysteresis width for HIGH, PASS or LOW judgment is disabled when the hold function is enabled.
- The hysteresis width is enabled when the self-trigger is set.



# Setting the Hold Function

Setting channels used when connecting multiple units: Each CH 1

Hold:

The hold function holds any values during the measurement period, and outputs these values at the end of measurement.

## Procedure for setting up hold

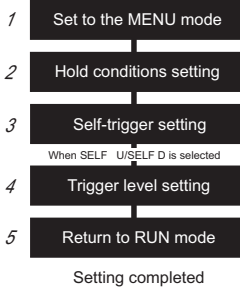









### 1 Set to the MENU mode







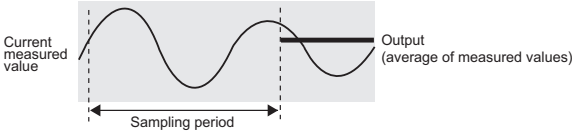

Button Operation	Display	Description of Operation	Explanation of Selection Menu
<p>Hold down for 3 seconds</p>		Hold down the  button for three seconds to switch to the MENU mode.	
<p>Press to display</p>		Press the  button to display <i>dETAL L</i> .	* This step is not required if detail menu display is already set to ON in the MENU mode.
<p>Press to display</p>		Press the  button to set the display to <i>ON</i> to set display of the detail menu.	
		Press the  button to apply the setting.	

- CONTENTS
- INTRODUCTION
- PREPARATION FOR MEASUREMENT
- FLOW OF OPERATION
- BASIC SETUP
- MAIN APPLICATIONS & SETTING METHODS
  - Height
  - Steps and Warpage
  - Double Sheet Detection
  - Thickness
  - Positioning
  - Eccentricity and Surface Deflection
- DETAILED SETTINGS
- TROUBLE-SHOOTING
- SPECIFICATIONS
- INDEX
- SETTING TRANSITION CHARTS

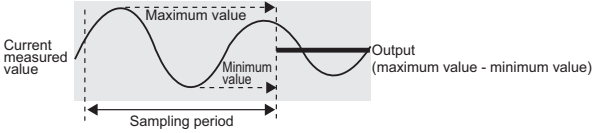
## 2 Hold conditions setting

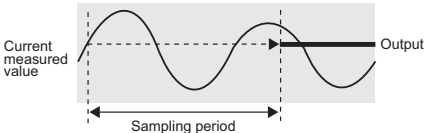

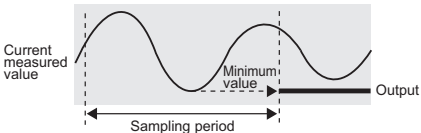

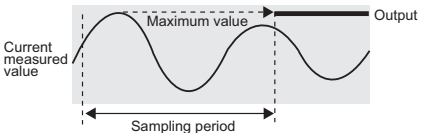



Button Operation	Display	Description of Operation	Explanation of Selection Menu
 <p>Press to display</p>		Press the  button to display <i>HOLD</i> .	<div style="border: 1px solid black; padding: 5px; display: inline-block;">Default value: OFF</div>
 <p>Press to select</p>	 <p>Select the desired value.</p>	Press the  button to select the hold conditions.	<div style="border: 1px solid black; padding: 2px; display: inline-block;"><i>OFF</i></div> Hold OFF <div style="border: 1px solid black; padding: 2px; display: inline-block;"><i>AVE</i></div> The average measured value during the sampling period is held. <div style="border: 1px solid black; padding: 2px; display: inline-block;"><i>P L O P</i></div> The difference between the minimum and maximum values during the sampling period is held. <div style="border: 1px solid black; padding: 2px; display: inline-block;"><i>SAMPLE</i></div> The measured value at the start of the sampling period is held. <div style="border: 1px solid black; padding: 2px; display: inline-block;"><i>BOTTOM</i></div> The minimum value during the sampling period is held. <div style="border: 1px solid black; padding: 2px; display: inline-block;"><i>PEAK</i></div> The maximum value during the sampling period is held. <b>(For details, see the following page.)</b>
 		Press the  button to apply the setting.  <div style="border-left: 1px solid black; border-right: 1px solid black; padding: 5px; display: inline-block;">             When other than <i>OFF</i> is selected, proceed to "3 Self-trigger setting."           </div>	* The clamp value is output until the first sampling period is finished. <b>(For details on the clamp value, see page 107.)</b>





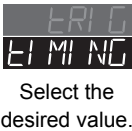

- CONTENTS
- INTRODUCTION
- PREPARATION FOR MEASUREMENT
- FLOW OF OPERATION
- BASIC SETUP
- MAIN APPLICATIONS & SETTING METHODS
- Height
- Steps and Warpage
- Double Sheet Detection
- Thickness
- Positioning
- Eccentricity and Surface Deflection
- DETAILED SETTINGS
- TROUBLE-SHOOTING
- SPECIFICATIONS
- INDEX
- SETTING TRANSITION CHARTS

Selection menu	Details
OFF (default)	Hold measurement is not performed. The measured value is output at all times.
	<p>The average measured value during the sampling period is held. The output changes at the end of the sampling period and is held until the end of the next sampling period.</p> 
	<p>The difference between the minimum and maximum values during the sampling period is held. This option is selected mainly to detect vibration. The output changes at the end of the sampling period and is held until the end of the next sampling period.</p> 
	<p>The measured value at the start of the sampling period is held. The output changes at the end of the sampling period and is held until the end of the next sampling period.</p> 
	<p>The minimum value during the sampling period is held. The output changes at the end of the sampling period and is held until the end of the next sampling period.</p> 
	<p>The maximum value during the sampling period is held. The output changes at the end of the sampling period and is held until the end of the next sampling period.</p> 



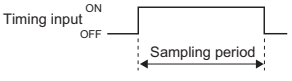

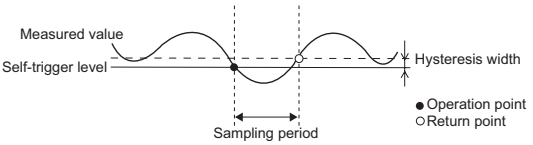

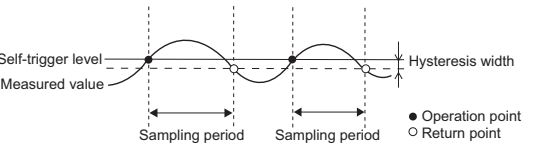



### 3 Self-trigger setting



- CONTENTS
- INTRODUCTION
- PREPARATION FOR MEASUREMENT
- FLOW OF OPERATION
- BASIC SETUP
- MAIN APPLICATIONS & SETTING METHODS
- Height
- Steps and Warpage
- Double Sheet Detection
- Thickness
- Positioning
- Eccentricity and Surface Deflection
- DETAILED SETTINGS
- TROUBLE-SHOOTING
- SPECIFICATIONS
- INDEX
- SETTING TRANSITION CHARTS

Button Operation	Display	Description of Operation	Explanation of Selection Menu
		Press the  button to display <i>E R I G</i> .	Default value: TIMING
		Press the  button to select the self-trigger.	<p><b>E I M I N G</b></p> <p>Enter the trigger by using the timing input or by pressing the  button in the RUN mode. The period that the timing signal is ON is the sampling period.</p> <p><b>SELF-d</b></p> <p>The sampling period is the period that the measured value is lower than the specified self-trigger level.</p> <p><b>SELF-U</b></p> <p>The sampling period is the period that the measured value is greater than the specified self-trigger level.</p> <p><b>(For details, see the following page.)</b></p>
		Press the  button to apply the self-trigger.	
		<p style="font-size: 1.2em;">( When <i>SELF-U</i> and <i>SELF-d</i> are selected, proceed to the next item, and when <i>E I M I N G</i> is selected, proceed to "5 Return to RUN mode."</p>	







Selection menu	Details
 <p>(Default)</p>	<p>Either input the timing signal from an external device, or enter the trigger for starting sampling by pressing the  button. The period that the timing signal is ON is the sampling period.</p>  <p><b>(For details on external inputs, see page 114.)</b></p>
	<p>The sampling period is the period that the measured value is lower than the specified self-trigger level. Hold measurement is possible without a sync input.</p> 
	<p>The sampling period is the period that the measured value is greater than the specified self-trigger level. Hold measurement is possible without a sync input.</p> 

## 4 Trigger level setting

Button Operation	Display	Description of Operation	Explanation of Selection Menu
 <p>Press to display</p>		<p>Press the  button to display SELF LV.</p>	<p>Default value: 0.000</p>
		<p>Press the  button to enable setting of the self-trigger level.</p>	
<p>[Change numeric value]</p>  <p>[Move right]</p> <p>Press to set.</p>	 <p>Set any value.</p>	<p>Press the  button to move the digit, press the  button to change the numeric value, and set the self-trigger level.</p>	<p>* If the  button is pressed when the cursor is at the right-most digit or the  button is pressed when the cursor is at the left-most digit, the setting will be canceled.</p>

Button Operation	Display	Description of Operation	Explanation of Selection Menu
 		Press the  button to apply the setting.	

## 5 Return to RUN mode

Button Operation	Display	Description of Operation	Explanation of Selection Menu
  <p>Hold down for 3 seconds</p>	  	Hold down the  button for three seconds to switch to the RUN mode.	

- CONTENTS
- INTRODUCTION
- PREPARATION FOR MEASUREMENT
- FLOW OF OPERATION
- BASIC SETUP
- MAIN APPLICATIONS & SETTING METHODS
- Height
- Steps and Warpage
- Double Sheet Detection
- Thickness
- Positioning
- Eccentricity and Surface Deflection
- DETAILED SETTINGS
- TROUBLE-SHOOTING
- SPECIFICATIONS
- INDEX
- SETTING TRANSITION CHARTS

# Bank Setting

Setting channels used when connecting multiple units  
 Bank switching: CH1  
 Bank registration: Each CH

## Bank setting:

Up to four sets of settings can be stored in memory. (Default: bank 0) This is recommended, for example, when measuring on multi-lot lines.

## Procedure for setting up banks

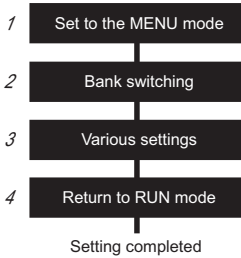

The following menu settings can be registered to banks:

HIGH threshold
LOW threshold
Response time
Hysteresis width
Measured value display scaling
Pre-scaling display value 1
Post-scaling display value 1
Pre-scaling display value 2
Post-scaling display value 2
Self-trigger level
Display during zero reset

## Important

- When connecting two or more Amplifier Units, use the CH1 Amplifier Unit for switching. The Amplifier Units of CH2 and later are switched together with CH1.

## 1 Set to the MENU mode

Button Operation	Display	Description of Operation	Explanation of Selection Menu
<p>Hold down for 3 seconds</p>		Hold down the  button for three seconds to switch to the MENU mode.	
<p>Press to display.</p>		Press the  button to display <i>dETAL L</i> .	* This step is not required if detail menu display is already set to ON in the MENU mode.
<p>Press to display.</p>		Press the  button to set the display to <i>ON</i> to set display of the detail menu.	
		Press the  button to apply the setting.	

CONTENTS

INTRODUCTION

PREPARATION FOR MEASUREMENT

FLOW OF OPERATION

BASIC SETUP

MAIN APPLICATIONS & SETTING METHODS

Height

Steps and Warpage

Double Sheet Detection

Thickness

Positioning

Eccentricity and Surface Deflection

DETAILED SETTINGS











TROUBLE-SHOOTING

SPECIFICATIONS

INDEX

SETTING TRANSITION CHARTS

## 2 Bank switching





Button Operation	Display	Description of Operation	Explanation of Selection Menu	
 Press to display		Press the  button to display <b>BANK</b> .	<table border="1" data-bbox="815 204 994 229"> <tr> <td>Default value: 0</td> </tr> </table>	Default value: 0
Default value: 0				
 Press to select	 Select the desired value.	Press the  button to select the bank.	 to 	
 		Press the  button to apply the setting.		

## 3 Various settings

Set the various menu items that require setting.

Execute smart tuning for each bank to be used because the smart tuning results are not applied to other banks.

## 4 Return to RUN mode

Button Operation	Display	Description of Operation	Explanation of Selection Menu
  Hold down for 3 seconds		Hold down the  button for three seconds to switch to the RUN mode.	

The following explains how to switch banks and perform measurement.

Either switch banks by following the steps 1 → 2 → 4 described above, or input the required signal from an external device to switch the bank.

(For details on external inputs, see page 114.)



## Zero reset:

This refers to setting the reference value to "0" or any desired numeric value so that the measured value can be displayed and output as a positive or negative deviation (tolerance) from the reference value. The measured value can be set to "0" or any desired numeric value at any timing in the RUN mode.

### Examples:

■ To eliminate reference deviation

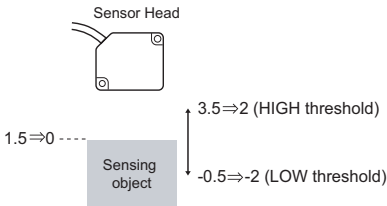

■ To measure steps in a sensing object (Executing a zero reset at each measurement)

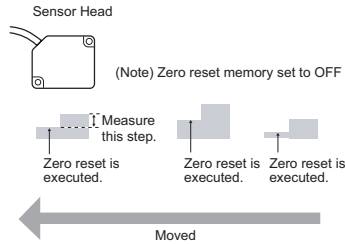

■ To display the height of a workpiece

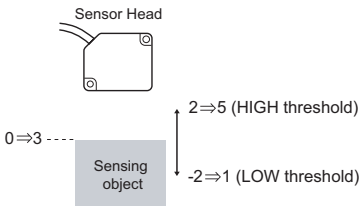

■ To display the actual measuring distance value

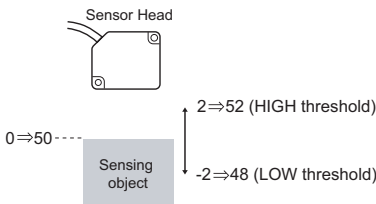

CONTENTS

INTRODUCTION

PREPARATION FOR MEASUREMENT

FLOW OF OPERATION

BASIC SETUP

MAIN APPLICATIONS & SETTING METHODS

Height

Steps and Warpage

Double Sheet Detection

Thickness

Positioning

Eccentricity and Surface Deflection

DETAILED SETTINGS

TROUBLE-SHOOTING

SPECIFICATIONS













INDEX

SETTING TRANSITION CHARTS

## Procedure for setting up zero reset









- 1 Set to the MENU mode
  - 2 Zero reset memory setting
  - 3 Display setting at zero reset
  - 4 Return to RUN mode
  - 5 Zero reset execution
- Setting completed



### 1 Set to the MENU mode

Button Operation	Display	Description of Operation	Explanation of Selection Menu
  <p>Hold down for 3 seconds</p>		Hold down the  button for three seconds to switch to the MENU mode.	
 <p>Press to display.</p>		Press the  button to display <i>DETAIL L</i> .	* This step is not required if detail menu display is already set to ON in the MENU mode.
 <p>Press to display.</p>		Press the  button to set the display to <i>ON</i> to set display of the detail menu.	
 		Press the  button to apply the setting.	

### 2 Zero reset memory setting

Select whether or not to hold the measured value after the zero reset was performed when the power is turned OFF.

Button Operation	Display	Description of Operation	Explanation of Selection Menu
 <p>Press to display.</p>		Press the  button to display <i>ZRMEM</i> .	Default value: OFF
 <p>Press to select</p>	 <p>Select the desired value.</p>	Press the  button to select the zero reset memory setting.	<p> <i>ON</i></p> <p>Saves the current measured result.</p> <p> <i>OFF</i></p> <p>Does not save the current measured result.</p> <p>When executing a zero reset at each measurement, set to <i>OFF</i>.</p>















Button Operation	Display	Description of Operation	Explanation of Selection Menu
 		Press the  button to apply the setting.	

**Important**





- If zero reset memory is set to ON, the zero reset level will be written in the Amplifier Unit's non-volatile memory (EEPROM) each time a zero reset is executed. The EEPROM can be written a maximum of 100,000 times. Writing the zero reset level for each measurement can, therefore, use up the life of the memory and lead to malfunctions.

### 3 Display setting at zero reset

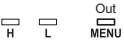

Set the zero reset memory function to set the reference value to any numeric value.

Button Operation	Display	Description of Operation	Explanation of Selection Menu
 Press to display		Press the  button to display ZR.dl SP.	<div style="border: 1px solid black; padding: 2px; display: inline-block;">Default value: 0.000</div>
		Press the  button to enable setting of values at a reset.	
[Change numeric value]  Press to set.	 Set any value.	Press the  button to move the digit, press the  button to change the numeric value, and set the offset level.	* If the  button is pressed when the cursor is at the right-most digit or the  button is pressed when the cursor is at the left-most digit, the setting will be canceled.
 		Press the  button to apply the setting.	

### 4 Return to RUN mode

Button Operation	Display	Description of Operation	Explanation of Selection Menu
  Hold down for 3 seconds		Hold down the  button for three seconds to switch to the RUN mode.	



## 5 Zero reset execution

Button Operation	Display	Description of Operation	Explanation of Selection Menu
—	—	Set the sensing object to be used for executing the zero reset.	
 Hold both down for 1 second		Either press the  button for one second in the RUN mode, or input the zero reset signal (4 ms to 1 s) from an external device.	<b>(For details on external inputs, see page 114.)</b>

### Important

- The minimum display value is  $-99.999$ , and the maximum display value is  $999.999$ . If the measured value is below the minimum value after execution of zero reset,  $-99.999$  will be displayed.  $999.999$  will be displayed if the measured value is above the maximum value. Zero reset can be executed only if the measured value is within  $\pm 10\%$  of the rated measurement range.
- Even if a zero reset is executed, the threshold does not change from the setting before execution of the zero reset.  
(For example, even if a zero reset is executed so that measured value 2 become 0, the HIGH threshold stays at 5 if it is 5 before zero reset is executed.)

### Procedure for canceling a zero reset

Button Operation	Display	Description of Operation	Explanation of Selection Menu
 Hold both down for 1 second		Either press the  button for one second in the RUN mode, or input the zero reset signal (3 s or more) from an external device.	

- CONTENTS
- INTRODUCTION
- PREPARATION FOR MEASUREMENT
- FLOW OF OPERATION
- BASIC SETUP
- MAIN APPLICATIONS & SETTING METHODS
- Height
- Steps and Warpage
- Double Sheet Detection
- Thickness
- Positioning
- Eccentricity and Surface Deflection
- DETAILED SETTINGS
- TROUBLE-SHOOTING
- SPECIFICATIONS
- INDEX
- SETTING TRANSITION CHARTS

## Scaling:

The display scale can be changed when you want to display a digital value on the Amplifier Unit different from the actual measured value. (For example, when you want to set the measured value as the actual measuring distance.)

### Procedure for setting up scaling

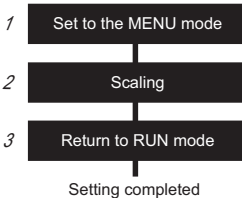

## 1 Set to the MENU mode

Button Operation	Display	Description of Operation	Explanation of Selection Menu
<p>Hold down for 3 seconds</p>		Hold down the  button for three seconds to switch to the MENU mode.	
<p>Press to display</p>		Press the  button to display <i>DETAIL L</i> .	* This step is not required if detail menu display is already set to ON in the MENU mode.
<p>Press to display</p>		Press the  button to set the display to <i>ON</i> to set display of the detail menu.	
		Press the  button to apply the setting.	

## 2 Scaling

Button Operation	Display	Description of Operation	Explanation of Selection Menu
<p>Press to display</p>		Press the  button to display <i>SCALE</i> .	<div style="border: 1px solid black; padding: 2px; display: inline-block;">Default value: OFF</div>

CONTENTS

INTRODUCTION

PREPARATION FOR MEASUREMENT

FLOW OF OPERATION

BASIC SETUP

MAIN APPLICATIONS & SETTING METHODS

Height

Steps and Warpage

Double Sheet Detection

Thickness

Positioning

Eccentricity and Surface Deflection



















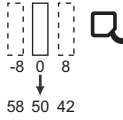
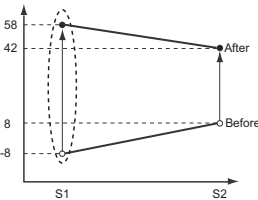











DETAILED SETTINGS



TROUBLE-SHOOTING













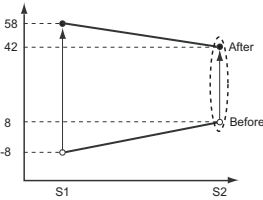













SPECIFICATIONS

INDEX





SETTING TRANSITION CHARTS

Button Operation	Display	Description of Operation	Explanation of Selection Menu
 Press to display.		Press the  button to display ON.	
 		Press the  button to enable setting of scaling.	
 Press to display.		Press the  button to display S1-BEF.	<p>&lt;To display the actual sensing distance&gt;</p>  
		Press the  button to enable setting of S1-Before.	
[Change numeric value]  [Move right] Press to set.	 [Numeric value before change] Set any value.	Press the  button to move the digit, press the  button to change the numeric value, and set the measured value before S1 is changed.	
 		Press the  button to apply the numeric value of S1-Before.	
 Press to display.		Press the  button to display S1-AFT.	
		Press the  button to enable setting of S1-After.	
[Change numeric value]  [Move right] Press to set.	 [Numeric value after change] Set any value.	Press the  button to move the digit, press the  button to change the numeric value, and set the measured value after S1 is changed.	
 		Press the  button to apply the numeric value of S1-After.	

\* If the  button is pressed when the cursor is at the right-most digit or the  button is pressed when the cursor is at the left-most digit, the setting will be canceled.

Button Operation	Display	Description of Operation	Explanation of Selection Menu
 Press to display		Press the  button to display S2-bEF.	 <p>* If the  button is pressed when the cursor is at the right-most digit or the  button is pressed when the cursor is at the left-most digit, the setting will be canceled.</p>
		Press the  button to enable setting of S2-Before.	
[Change numeric value] [Move digit]  Press to set.	 [Numeric value before change] Set any value.	Press the  button to move the digit, press the  button to change the numeric value, and set the measured value before S2 is changed.	
SMART MENU/SET  		Press the  button to apply the numeric value of S2-Before.	
 Press to display		Press the  button to display S2-AFT.	
		Press the  button to enable setting of S2-After.	
[Change numeric value] [Move digit]  Press to set.	 [Numeric value after change] Set any value.	Press the  button to move the digit, press the  button to change the numeric value, and set the measured value after S2 is changed.	
SMART MENU/SET  		Press the  button to apply the numeric value of S2-After.	

### 3 Return to RUN mode

Button Operation	Display	Description of Operation	Explanation of Selection Menu
SMART MENU/SET   Hold down for 3 seconds		Hold down the  button for three seconds to switch to the RUN mode.	

## Important

- Analog output when specifying the scaling setting

The analog output range is assigned based on the post-scaling display value setting range (between S1-AFT and S2-AFT).

Concerning the minimum and maximum analog output values, the analog output minimum value is output for the smaller of the post-scaling display values (S1-AFT/S2-AFT), and the analog output maximum value is output for the larger of these values.

Example: To set the analog output in the range of  $-5\text{ V}$  to  $5\text{ V}$  and display a value from  $45\text{ mm}$  to  $55\text{ mm}$  when using the ZX2-LD50(L) at a distance of  $45\text{ mm}$  to  $55\text{ mm}$  from the sensor:

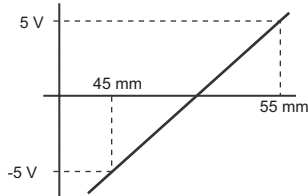

- (1) Select  $-5$  ,  $5$  as the analog output setting.
- (2) Specify the AFT value, and then assign the display value based on the measured value. Assign the analog output range based on the display value range.

- S1-BEF:  $-5$  (mm)
- S1-AFT:  $55$  (mm)
- S2-BEF:  $5$  (mm)
- S2-AFT:  $45$  (mm)

<Initial setting>

Display value	Analog output
$-10\text{ mm}$	$-5\text{ V}$
$10\text{ mm}$	$5\text{ V}$



<Scaling setting>

Scaling point	Pre-scaling display value (BEF)	Post-scaling display value (AFT)	Analog output
S1	$-5\text{ mm}$	$55\text{ mm}$	$5\text{ V}$
S2	$5\text{ mm}$	$45\text{ mm}$	$-5\text{ V}$

- Threshold value when specifying the scaling setting

Even if scaling is executed, the threshold does not change from the setting before execution of scaling. (For example, the HIGH threshold stays at 5 if it was 5 before scaling is executed.)



# Analog Output

Setting channels used when connecting multiple units: Each CH

Analog output:

This refers to the conversion of measurement results to 4 to 20 mA current output or to -5 to +5 V/1 to 5 V voltage output.

The relationship between display values and analog output values can be freely specified. (Monitor focus)

## Procedure for setting up analog output

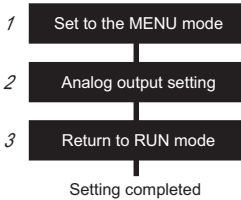

### 1 Set to the MENU mode

Button Operation	Display	Description of Operation	Explanation of Selection Menu
<p>Hold down for 3 seconds</p>		Hold down the  button for three seconds to switch to the MENU mode.	

### 2 Analog output setting

Button Operation	Display	Description of Operation	Explanation of Selection Menu
<p>Press to display.</p>		Press the  button to display A-OUT.	<div style="border: 1px solid black; padding: 2px;">Default value: -5 to +5 V</div>
<p>Press to select</p>	<p>Select the desired value.</p>	Press the  button to select analog output.	<div style="border: 1px solid black; padding: 2px;">4.20mA</div> Current output 4 to 20 mA <div style="border: 1px solid black; padding: 2px;">1.5V</div> Voltage output 1 to 5 V <div style="border: 1px solid black; padding: 2px;">-5.5V</div> Voltage output 5 to +5 V
		Press the  button to apply the setting.	

CONTENTS

INTRODUCTION

PREPARATION FOR MEASUREMENT

FLOW OF OPERATION

BASIC SETUP

MAIN APPLICATIONS & SETTING METHODS

Height

Steps and Warpage

Double Sheet Detection

Thickness

Positioning

Eccentricity and Surface Deflection

DETAILED SETTINGS



TROUBLE-SHOOTING

SPECIFICATIONS

INDEX

SETTING TRANSITION CHARTS

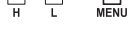
### 3 Return to RUN mode

Button Operation	Display	Description of Operation	Explanation of Selection Menu
 Hold down for 3 seconds		Hold down the  button for three seconds to switch to the RUN mode.	

#### Freely specifying the relationship between display values and analog output values (equivalent to the former ZX-L-N monitor focus)

- To specify any analog output value for a display value, assign the analog output range and the minimum and maximum analog output values by selecting the analog output and then setting up scaling.  
(If scaling is not set up, the measurement range is the same as the analog output range.)

The analog output range is assigned based on the post-scaling display value setting range (between S1-AFT and S2-AFT).

Concerning the minimum and maximum analog output values, the analog output minimum value is output for the smaller of the post-scaling display values (S1-AFT/S2-AFT), and the analog output maximum value is output for the larger of these values.

- To only specify the analog output range, without changing display values

Example: To set the analog output in the range of  $-5\text{ V}$  to  $5\text{ V}$  when using the ZX2-LD50(L) at a distance of 45 mm to 55 mm from the sensor:

- Select  $-5$  ,  $5$  as the analog output setting.
- Specify the measurement range to use for the BEF and AFT values, and then assign the analog output range based on the measured value range.

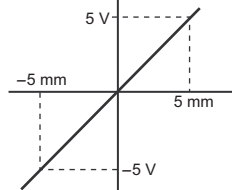

- S1-BEF:  $-5\text{ (mm)}$
- S1-AFT:  $-5\text{ (mm)}$  → Set the same value as S1-BEF
- S2-BEF:  $5\text{ (mm)}$
- S2-AFT:  $5\text{ (mm)}$  → Set the same value as S2-BEF

<Initial setting>

Display value	Analog output
$-10\text{ mm}$	$-5\text{ V}$
$10\text{ mm}$	$5\text{ V}$

<Scaling setting>

Scaling point	Pre-scaling display value (BEF)	Post-scaling display value (AFT)	Analog output
S1	$-5\text{ mm}$	$-5\text{ mm}$	$-5\text{ V}$
S2	$5\text{ mm}$	$5\text{ mm}$	$5\text{ V}$

- To specify the analog output range after changing display values  
(For details on scaling, see page 104.)

# Output for Non-measurement

Setting channels used when connecting multiple units: Each CH 1

Output for non-measurement:

This refers to specifying the output contents when an error occurs (Error-dark or Error-bright), when a reset is being input, or before measured values are finalized.

(For details on these errors, see page 126.)

Selection Menu	Output Contents	
	Judgment Output	Analog Output
KEEP (Default)	The measurement value immediately before the non-measurement state is entered is held and output.	
CLAMP	All OFF	<p>The specified CLAMP value is output. The following options are available.</p> <ul style="list-style-type: none"> <li>For voltage output: -5.00 to 5.00 V (in 1-V steps), or the maximum (approximately 5.5 V)</li> <li>For current output: 4.00 to 20.00 mA (in 1-mA steps), or the maximum (approximately 22 mA)</li> </ul>

## Procedure for setting up output for non-measurement

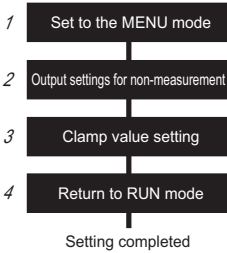

### 1 Set to the MENU mode

Button Operation	Display	Description of Operation	Explanation of Selection Menu
<p>Hold down for 3 seconds</p>		Hold down the  button for three seconds to switch to the MENU mode.	
<p>Press to display.</p>		Press the  button to display DETAIL L.	* This step is not required if detail menu display is already set to ON in the MENU mode.
<p>Press to display.</p>		Press the  button to set the display to ON to set display of the detail menu.	
		Press the  button to apply the setting.	

CONTENTS

INTRODUCTION

PREPARATION FOR MEASUREMENT

FLOW OF OPERATION

BASIC SETUP

MAIN APPLICATIONS & SETTING METHODS

Height

Steps and Warpage

Double Sheet Detection

Thickness

Positioning

Eccentricity and Surface Deflection

DETAILED SETTINGS









TROUBLE-SHOOTING

SPECIFICATIONS















INDEX

SETTING TRANSITION CHARTS







## 2 Output settings for non-measurement

Button Operation	Display	Description of Operation	Explanation of Selection Menu
 Press to display		Press the  button to display <i>RSTOUT</i> .	<div style="border: 1px solid black; padding: 2px; display: inline-block;">Default value: KEEP</div>
 Press to select	 Select the desired value.	Press the  button to select output for non-measurement.	<b>KEEP</b> The measured value status before measurement is stopped is held and output.
 SMART  MENU/SET		Press the  button to apply the setting.	<b>CLAMP</b> Judgment output: All OFF Analog output: The preset clamp value is output.

## 3 Clamp value setting

Button Operation	Display	Description of Operation	Explanation of Selection Menu
 Press to display		Press the  button to display <i>CLAMP</i> .	<div style="border: 1px solid black; padding: 2px; display: inline-block;">Default value: MAX</div> The clamp value is output from when the power is turned on until the measured value is finalized, even when KEEP is selected, so be sure to set this value.
 Press to select	 Select the desired value.	Press the  button to display the clamp value.	For voltage output:  to  In 1 V units  For current output:  to  In 1 mA units 
 SMART  MENU/SET		Press the  button to apply the setting.	

## 4 Return to RUN mode

Button Operation	Display	Description of Operation	Explanation of Selection Menu
  <p>Hold down for 3 seconds</p>	  	Hold down the  button for three seconds to switch to the RUN mode.	

CONTENTS

INTRODUCTION

PREPARATION FOR MEASUREMENT

FLOW OF OPERATION

BASIC SETUP

MAIN APPLICATIONS & SETTING METHODS

Height

Steps and Warpage

Double Sheet Detection

Thickness

Positioning

Eccentricity and Surface Deflection

DETAILED SETTINGS

TROUBLE-SHOOTING

SPECIFICATIONS

INDEX

SETTING TRANSITION CHARTS

## Timer:

The timing for judgement outputs can be adjusted to match the operation of external devices.

### Procedure for setting up the timer

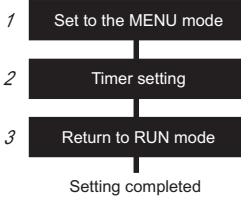













## 1 Set to the MENU mode

Button Operation	Display	Description of Operation	Explanation of Selection Menu
 Hold down for 3 seconds		Hold down the  button for three seconds to switch to the MENU mode.	
 Press to display		Press the  button to display <i>DETAIL L</i> .	* This step is not required if detail menu display is already set to ON in the MENU mode.
 Press to display		Press the  button to set the display to <i>ON</i> to set display of the detail menu.	
		Press the  button to apply the setting.	



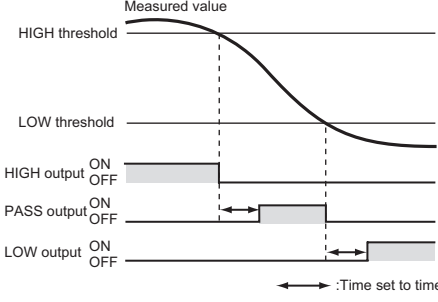

## 2 Timer setting

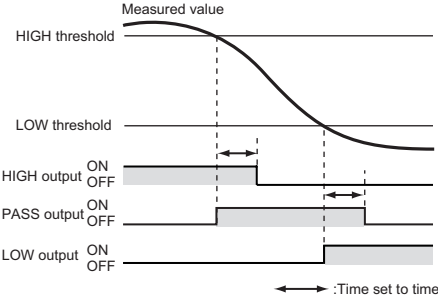
Button Operation	Display	Description of Operation	Explanation of Selection Menu
 Press to display	 Select the desired value.	Press the  button to display <i>ONELM</i> when setting the ON-delay and <i>OFFELM</i> when setting the OFF-delay.	 ON-delay timer  OFF-delay timer <b>(For details, see the following page.)</b>
		Press the  button to enable setting of the timer.	

Button Operation	Display	Description of Operation	Explanation of Selection Menu
 <p>[Change numeric value]</p>		Press the  button to move the digit, press the  button to change the numeric value, and set the time set to the timer.	 * If the  button is pressed when the cursor is at the right-most digit or the  button is pressed when the cursor is at the left-most digit, the setting will be canceled.
 		Press the  button to apply the setting.	

Selection menu	Details
 (ON-delay timer)	<p>After the measurement result has been finalized, the timer delays turning ON of the PASS output for the time set to the timer.</p> 
 (OFF-delay timer)	<p>After the measurement result has been finalized, the timer delays turning OFF of the PASS output for the time set to the timer.</p> 

### 3 Return to RUN mode

Button Operation	Display	Description of Operation	Explanation of Selection Menu
  Hold down for 3 seconds	 	Hold down the  button for three seconds to switch to the RUN mode.	

CONTENTS

INTRODUCTION

PREPARATION FOR MEASUREMENT

FLOW OF OPERATION

BASIC SETUP

MAIN APPLICATIONS & SETTING METHODS

Height

Steps and Warpage

Double Sheet Detection

Thickness

Positioning

Eccentricity and Surface Deflection

DETAILED SETTINGS

TROUBLE-SHOOTING

SPECIFICATIONS

INDEX

SETTING TRANSITION CHARTS

# Setting the Differential Function

[ Setting channels used when connecting multiple units: Each CH ]

## Differential function:

This function is used to specify the detection of only sudden changes in the measured values that occur during very short periods of time.

### Setting example:

■ Detecting only sudden changes.

■ Counting gradual changes for which a threshold value cannot be specified.

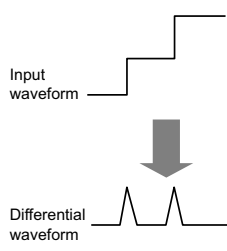
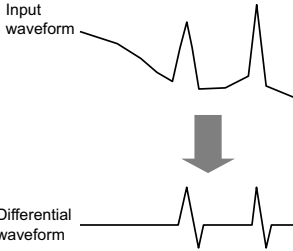

## Procedure for setting up differential function

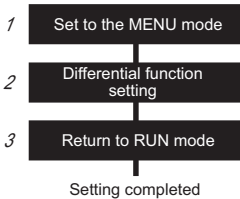









### 1 Set to the MENU mode



Button Operation	Display	Description of Operation	Explanation of Selection Menu
 Hold down for 3 seconds		Hold down the  button for three seconds to switch to the MENU mode.	
 Press to display.		Press the  button to display <i>DETAIL L</i> .	* This step is not required if detail menu display is already set to ON in the MENU mode.
 Press to display.		Press the  button to set the display to <i>ON</i> to set display of the detail menu.	
		Press the  button to apply the setting.	



## 2 Differential function setting

Button Operation	Display	Description of Operation	Explanation of Selection Menu
		Press the  button to display <i>dl FF</i> .	
		Press the  button to set the display to <i>ON</i> .	
		Press the  button to apply the setting.	

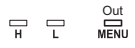
## 3 Return to RUN mode

Button Operation	Display	Description of Operation	Explanation of Selection Menu
		Hold down the  button for three seconds to switch to the RUN mode.	

CONTENTS

INTRODUCTION

PREPARATION FOR MEASUREMENT

FLOW OF OPERATION

BASIC SETUP

MAIN APPLICATIONS &amp; SETTING METHODS

Height

Steps and Warpage

Double Sheet Detection

Thickness

Positioning

Eccentricity and Surface Deflection

DETAILED SETTINGS

TROUBLE-SHOOTING

SPECIFICATIONS

INDEX

SETTING TRANSITION CHARTS

# External Input for Bank, Timing Input, Reset Input

[ Setting channels used when connecting multiple units: Each CH, Bank switching: CH1 ]

External input:

This refers to inputting the bank switching signal, the timing signal during a hold and the reset signal from an external device to execute these operations.

## Procedure for setting up external input

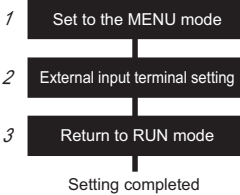









### 1 Set to the MENU mode

Button Operation	Display	Description of Operation	Explanation of Selection Menu
<p>Hold down for 3 seconds</p>		Hold down the  button for three seconds to switch to the MENU mode.	
<p>Press to display.</p>		Press the  button to display <i>DETAIL L</i> .	* This step is not required if detail menu display is already set to ON in the MENU mode.
<p>Press to display.</p>		Press the  button to set the display to <i>ON</i> to set display of the detail menu.	
		Press the  button to apply the setting.	





### 2 External input terminal setting

Button Operation	Display	Description of Operation	Explanation of Selection Menu
<p>Press to display.</p>		Press the  button to display <i>EXT-IN</i> .	<div style="border: 1px solid black; padding: 5px; display: inline-block;">Default value: TIM.RST</div>

CONTENTS
INTRODUCTION
PREPARATION FOR MEASUREMENT
FLOW OF OPERATION
BASIC SETUP
MAIN APPLICATIONS & SETTING METHODS
Height
Steps and Warpage
Double Sheet Detection
Thickness
Positioning
Eccentricity and Surface Deflection
DETAILED SETTINGS
TROUBLE-SHOOTING
SPECIFICATIONS
INDEX
SETTING TRANSITION CHARTS

Button Operation	Display	Description of Operation	Explanation of Selection Menu
 Press to select	 Select the desired value.	Press the  button to select the external input terminal.	 timing input/reset input  Bank switching
 		Press the  button to apply the setting.	

### 3 Return to RUN mode

Button Operation	Display	Description of Operation	Explanation of Selection Menu
  Hold down for 3 seconds		Hold down the  button for three seconds to switch to the RUN mode.	

#### Procedure for executing external input

Each of the functions is executed when signals are input using the external input wire in table 1 below.

Timing input, reset input and bank switching are executed by a signal input of 4 ms or more. While the signal in table 2 below is being input, measurement is performed based on the settings of the specified bank.

When connecting two or more Amplifier Units, use the CH1 Amplifier Unit for bank switching. The banks of the Amplifier Units of CH2 and later are switched together with CH1.

Table 1 External Input Wiring



Setting	Amplifier Unit Connector Cable Color	Purple	Red
			Timing input
		BANK input 0	BANK input 1

Table 2 Bank Signal Switching Wiring

	BANK Input 0 (purple)	BANK Input 1 (red)
BANK 0	OFF	OFF
BANK 1	ON	OFF
BANK 2	OFF	ON
BANK 3	ON	ON

Note: Bank signal switching is enabled only in the RUN mode.

# Setting the Detection Surface Selection

[ Setting channels used when connecting multiple units: Each CH ]

## Detection surface selection:

The default value is FIRST. Setting the value to MAX can decrease incorrect measurements caused by diffused reflection or multireflection due to the shape of the workpiece.

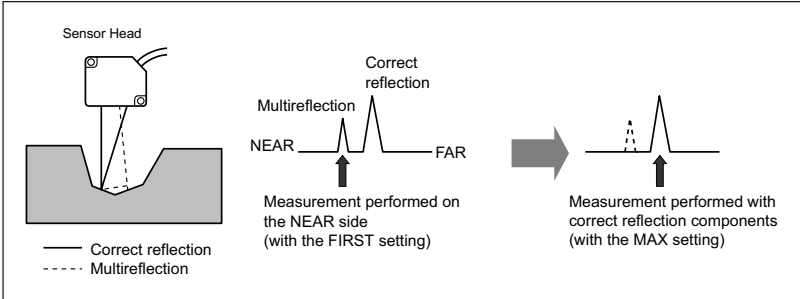











## Procedure for setting up detection surface selection

- 1 Set to the MENU mode
  - 2 Detection surface selection setting
  - 3 Return to RUN mode
- Setting completed





### 1 Set to the MENU mode

Button Operation	Display	Description of Operation	Explanation of Selection Menu
Hold down for 3 seconds 		Hold down the  button for three seconds to switch to the MENU mode.	
Press to display		Press the  button to display <i>DETAIL L</i> .	* This step is not required if detail menu display is already set to ON in the MENU mode.
Press to display.		Press the  button to set the display to <i>ON</i> to set display of the detail menu.	
		Press the  button to apply the setting.	

## 2 Detection surface selection setting

Button Operation	Display	Description of Operation	Explanation of Selection Menu
 Press to display		Press the  button to display <i>dEtECT</i> .	
 Press to select	 Select the desired value.	Press the  button to display <i>MAx</i> .	 During normal measurement  When an incorrect measurement occurs due to diffused reflection or multireflection
 		Press the  button to apply the setting.	

## 3 Return to RUN mode

Button Operation	Display	Description of Operation	Explanation of Selection Menu
  Hold down for 3 seconds		Hold down the  button for three seconds to switch to the RUN mode.	

CONTENTS

INTRODUCTION

PREPARATION FOR MEASUREMENT

FLOW OF OPERATION

BASIC SETUP

MAIN APPLICATIONS &amp; SETTING METHODS

Height

Steps and Warpage

Double Sheet Detection

Thickness

Positioning

Eccentricity and Surface Deflection

DETAILED SETTINGS

TROUBLE-SHOOTING

SPECIFICATIONS



INDEX

SETTING TRANSITION CHARTS



## Key Lock Function:

The key lock function disables all keys. Once keys have been disabled, no key input will be accepted until the lock is released. This function is useful for preventing inadvertent changes to settings.

## Key Lock Function

Button Operation	Display	Description of Operation	Explanation of Selection Menu
 <p>Hold both down for 3 seconds</p>		Hold both the  buttons down for three seconds in the RUN mode.	

## Canceling the Key Lock

Button Operation	Display	Description of Operation	Explanation of Selection Menu
 <p>Hold both down for 3 seconds</p>	 <p>Displayed until completion of cancellation</p>	Hold both the  buttons down for three seconds in the RUN mode.	

## CONTENTS

## INTRODUCTION

## PREPARATION FOR MEASUREMENT

## FLOW OF OPERATION

## BASIC SETUP

## MAIN APPLICATIONS & SETTING METHODS

## Height

## Steps and Warpage

## Double Sheet Detection

## Thickness

## Positioning

## Eccentricity and Surface Deflection

## DETAILED SETTINGS

## TROUBLE-SHOOTING

## SPECIFICATIONS

## INDEX

## SETTING TRANSITION CHARTS

# Initializing Settings Data

Setting channels used when connecting multiple units: Each CH

Initialization: This function resets all settings to their default values.

## Default Values

Function	Default Value
Display	0 reference: Measurement center distance + indication: NEAR side - indication: FAR side
HIGH threshold	Measurement range maximum value
LOW threshold	Measurement range minimum value
Response time	500 ms
Analog output setting	-5 to +5 V
Detail menu display selection	OFF
Bank switching settings	0
Mutual interference prevention	OFF
Hysteresis width	0.000
Two-Sensor operation setting	OFF
Thickness setting	0.000
Measured value display scaling	OFF
Differential function	OFF
Hold setting	OFF
Trigger mode	TIMING (self-trigger timing input)
Self-trigger level	0.000
Output for non-measurement	KEEP
Clamp value	MAX
ON-delay time	0 ms
OFF-delay time	0 ms
Zero reset memory	OFF
Display during zero reset	0.000
External input terminal setting	TIM.RST (timing input/reset input)
Detection surface selection	FIRST

CONTENTS

INTRODUCTION

PREPARATION FOR MEASUREMENT

FLOW OF OPERATION

BASIC SETUP

MAIN APPLICATIONS & SETTING METHODS

Height

Steps and Warpage

Double Sheet Detection

Thickness

Positioning

Eccentricity and Surface Deflection

DETAILED SETTINGS

TROUBLE-SHOOTING

SPECIFICATIONS

INDEX

SETTING TRANSITION CHARTS

## Procedure for initializing settings data

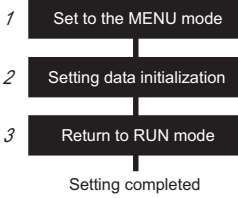





### Important











- When connecting two or more Amplifier Units, use CH1 to perform initialization because CH2 and later channels cannot be used to do this.

Note that CH2 and later channels are initialized together with CH1.

## 1 Set to the MENU mode







Button Operation	Display	Description of Operation	Explanation of Selection Menu
  Hold down for 3 seconds	 	Hold down the  button for three seconds to switch to the MENU mode.	

## 2 Setting data initialization

Button Operation	Display	Description of Operation	Explanation of Selection Menu
 Press to display		Press the  button to display INI E.	
 Press to display.		Press the  button to display EXE.	
  Hold down	 Displayed 1 digit at a time	Press the  button.	
		When <b>OK</b> is displayed, this means that initialization is completed.	



### 3 Return to RUN mode

Button Operation	Display	Description of Operation	Explanation of Selection Menu
  <p>Hold down for 3 seconds</p>	  	Hold down the  button for three seconds to switch to the RUN mode.	

CONTENTS

INTRODUCTION

PREPARATION FOR MEASUREMENT

FLOW OF OPERATION

BASIC SETUP

MAIN APPLICATIONS & SETTING METHODS

Height

Steps and Warpage

Double Sheet Detection

Thickness

Positioning

Eccentricity and Surface Deflection

DETAILED SETTINGS

TROUBLE-SHOOTING

SPECIFICATIONS

INDEX

SETTING TRANSITION CHARTS

**CONTENTS**

**INTRODUCTION**

**PREPARATION  
FOR  
MEASUREMENT**

**FLOW OF  
OPERATION**

**BASIC  
SETUP**

**MAIN  
APPLICATIONS  
& SETTING  
METHODS**

**Height**

**Steps  
and  
Warpage**

**Double  
Sheet  
Detection**

**Thickness**

**Positioning**

**Eccentricity  
and Surface  
Deflection**

**DETAILED  
SETTINGS**

**TROUBLE-  
SHOOTING**

**SPECIFI-  
CATIONS**

**INDEX**

**SETTING  
TRANSITION  
CHARTS**

# TROUBLESHOOTING

---

<b>Troubleshooting</b>	<b>124</b>
<b>Error Messages</b>	<b>126</b>
<b>Q&amp;A</b>	<b>129</b>

# Troubleshooting

This section describes countermeasures for temporary hardware problems. Check the malfunction in this section before sending the hardware for repair.

Category	Problem	Probable cause and possible countermeasure	Pages
Operation	The device restarts during operation.	<ul style="list-style-type: none"> <li>Is the power supply device connected correctly?</li> <li>Are the Calculating Units connected correctly?</li> </ul>	p.28 p.25
	No input signal is received.	<ul style="list-style-type: none"> <li>Are all cables connected correctly?</li> <li>Is the input signal line disconnected?</li> </ul>	p.28
	The measured values fluctuate and are not stable depending on day and time.	This problem may be due to temperature characteristics. Execute zero reset periodically using the standard object to correct this problem.	p.97
	Laser light is not emitted.	<ul style="list-style-type: none"> <li>Is the LD-OFF input short-circuited?</li> </ul>	p.28
	Bank switching by signals from the external input terminal is not functioning.	<ul style="list-style-type: none"> <li>Is the external input terminal set to <i>BANK?</i></li> <li>Is the cable connected correctly?</li> </ul>	p.114 p.28
	The state returns to <i>BANK 0</i> in the RUN mode even if after a bank is switched by button operation.	<ul style="list-style-type: none"> <li>Is the external input terminal set to <i>ELIMRSLT?</i></li> </ul>	p.114
	Display	The main display stays at [----].	<ul style="list-style-type: none"> <li>Has a timing input been made while hold is enabled and the the trigger mode is <i>ELIMING?</i></li> <li>If the hold function is enabled and the trigger type is <i>SELF-U</i> or <i>SELF-d</i>, has the self-trigger level been set to an appropriate value?</li> </ul>
An abnormal distance is displayed when the object is clearly outside the measurement range.		This problem may occur due to the characteristics of the sensor. Make sure that the distance to the sensing object is appropriate.	—
<i>LdDOWN</i> is displayed on the sub-display when the power is turned ON.		The laser of the Sensor Head has deteriorated. Replace the Sensor Head.	—
<i>LdOFF</i> is displayed on the sub-display.		<ul style="list-style-type: none"> <li>Is the LD-OFF input short-circuited?</li> </ul>	p.28
<i>ELIMING</i> is displayed on the sub-display.		<ul style="list-style-type: none"> <li>Is the timing input short-circuited?</li> </ul>	p.28
<i>RESET</i> is displayed on the sub-display.		<ul style="list-style-type: none"> <li>Is the reset input short-circuited?</li> </ul>	p.28
Even though the installation conditions are the same, measured values differ considerably.		<ul style="list-style-type: none"> <li>Is the zero-reset input short-circuited?</li> </ul>	p.28

Category	Problem	Probable cause and possible countermeasure	Pages
Display	<i>E-bRIGHT</i> is displayed on the main display.	<ul style="list-style-type: none"> <li>Is the distance between the Sensor Head and the workpiece within the measurement range?</li> </ul>	p.135
	<i>E-dARK</i> is displayed on the main display.	<ul style="list-style-type: none"> <li>Is the distance between the Sensor Head and the workpiece within the measurement range?</li> </ul>	p.135
Output	Judgements are not output to external devices.	<ul style="list-style-type: none"> <li>Are all cables connected correctly?</li> <li>Is the output signal line disconnected?</li> <li>Is the reset input short-circuited?</li> <li>Is the HIGH threshold set to a value larger than the LOW threshold?</li> </ul>	p.28
	Analog output levels are strange.	<ul style="list-style-type: none"> <li>Are the analog output settings correct?</li> </ul>	p.105

CONTENTS

INTRODUCTION

PREPARATION FOR MEASUREMENT

FLOW OF OPERATION

BASIC SETUP

MAIN APPLICATIONS & SETTING METHODS

Height

Steps and Warpage

Double Sheet Detection

Thickness

Positioning

Eccentricity and Surface Deflection

DETAILED SETTINGS

TROUBLE-SHOOTING

SPECIFICATIONS











INDEX









SETTING TRANSITION CHARTS

# Error Messages

This section outlines the error messages displayed on the Amplifier Unit and the countermeasures for those messages.

While displaying an error, the error output signal is also output. (There are some exceptions.)

Display	Error	Countermeasure
Error-bright 	Saturated light amount intensity, measurement error. (The error output signal is not output.)	<ul style="list-style-type: none"> <li>Install so that the distance between the Sensor Head and the workpiece is within the measurement range.</li> </ul>
Error-channel 	<ul style="list-style-type: none"> <li>There is only one Amplifier Unit even though mutual interference prevention is set to ON.</li> <li>There is only one Amplifier Unit even though two-Sensor operation is set to ON.</li> </ul>	<ul style="list-style-type: none"> <li>If two or more Amplifier Units have been installed, turn OFF the power supply and check that the Amplifier Units and Calculating Units are connected correctly.</li> <li>If only one Amplifier Unit is being used, connect another Amplifier Unit temporarily and turn OFF mutual interference prevention and two-Sensor operation, or initialize the setting data.</li> </ul>
Error-channel 	Two Amplifier Unit communications error.	
Error-dark 	Insufficient received light intensity, measurement error. (The error output signal is not output.)	<ul style="list-style-type: none"> <li>Install so that the distance between the Sensor Head and the workpiece is within the measurement range.</li> </ul>
Error-head 	The Sensor Head is disconnected. Or, a sensor communications error has occurred.	<ul style="list-style-type: none"> <li>Turn OFF the power supply, check the Sensor Head connection, and then turn ON the power supply again.</li> <li>If the above countermeasure does not solve the problem, the Sensor Head is malfunctioning. Replace the Sensor Head.</li> </ul>
Error-head 		
Error-head 		
Error-head 	Sensor Head laser error.	
Error-head 	The Sensor Head internal memory is in error.	
Error-head 		

Display	Error	Countermeasure
Error-head 	Sensor Head system error.	<ul style="list-style-type: none"> <li>• Turn OFF the power supply, check the Sensor Head connection, and then turn ON the power supply again.</li> <li>• If the above countermeasure does not solve the problem, the Sensor Head is malfunctioning. Replace the Sensor Head.</li> </ul>
Error-head 		
Error-head 		
Error-head 	Because the Sensor Head version is old, the connected Amplifier Unit cannot be used.	<ul style="list-style-type: none"> <li>• Contact the company with which your company is doing business or the OMRON sales representative handling your company.</li> </ul>
Error-memory 	Amplifier Unit setting memory error.	<ul style="list-style-type: none"> <li>• Turn OFF the power supply, check if wiring is connected correctly, and then turn ON the power supply again.</li> <li>• If the above countermeasure does not solve the problem, the Amplifier Unit is malfunctioning. Replace the Amplifier Unit.</li> </ul>
Error-memory 	Amplifier Unit setting memory error.	<ul style="list-style-type: none"> <li>• Initialize the settings by holding down the SET key for at least three seconds.</li> <li>• If the above countermeasure does not solve the problem, the Amplifier Unit is malfunctioning. Replace the Amplifier Unit.</li> </ul>
Error-short 	One or all of the judgment outputs are short-circuited.	<ul style="list-style-type: none"> <li>• Turn OFF the power supply, check that the HIGH, PASS, LOW or error output lines are not short-circuited, then turn ON the power supply again.</li> </ul>
Error-system 	Amplifier Unit system error.	<ul style="list-style-type: none"> <li>• Turn OFF the power supply, check if wiring is connected correctly, and then turn ON the power supply again.</li> <li>• If the above countermeasure does not solve the problem, the Amplifier Unit is malfunctioning. Replace the Amplifier Unit.</li> </ul>
Tuning-failed 	Smart Tuning failed. (The error output signal is not output.)	<ul style="list-style-type: none"> <li>• Change the response time setting to a larger value, and try again.</li> <li>• Make sure that the distance between the Sensor and Workpiece is within the measurement range, and try again.</li> </ul>

CONTENTS

INTRODUCTION

PREPARATION  
FOR  
MEASUREMENTFLOW OF  
OPERATIONBASIC  
SETUPMAIN  
APPLICATIONS  
& SETTING  
METHODS

Height

Steps  
and  
WarpageDouble  
Sheet  
Detection



Thickness

Positioning

Eccentricity  
and Surface  
DeflectionDETAILED  
SETTINGSTROUBLE-  
SHOOTINGSPECIFI-  
CATIONS

INDEX

SETTING  
TRANSITION  
CHARTS

Display	Error	Countermeasure
LD.down 	The laser of the Sensor Head has deteriorated.	<ul style="list-style-type: none"> <li>Replace the Sensor Head.</li> </ul>
	Measured values are not output because the reset signal is being input, calculations are in progress, timing is before the hold sampling time, etc. (The error output signal is not output.)	<ul style="list-style-type: none"> <li>Normally, measured values are displayed once they can be output.</li> </ul>

- CONTENTS
- INTRODUCTION
- PREPARATION FOR MEASUREMENT
- FLOW OF OPERATION
- BASIC SETUP
- MAIN APPLICATIONS & SETTING METHODS
- Height
- Steps and Warpage
- Double Sheet Detection
- Thickness
- Positioning
- Eccentricity and Surface Deflection
- DETAILED SETTINGS
- TRUBLE-SHOOTING
- SPECIFICATIONS
- INDEX
- SETTING TRANSITION CHARTS



Question	Answer
What is the positional variation range with respect to the machine axis of the emitter beam spot?	The range is $\pm 0.5^\circ$ of the ideal emitter axis in the dimensional drawing on page 134.
After the response time is changed, is it necessary to re-execute smart tuning?	Yes. After the response time is changed, the smart tuning results are cleared. Therefore, re-execute tuning.
If using a different bank for the first time, is it necessary to execute smart tuning?	Yes. The smart tuning results are not applied to other banks. If using a different bank for the first time, execute smart tuning.
For the line beam type, is it possible to detect beam-spot-internal steps?	Spot-internal steps cannot be measured. Use the line beam spot so that it is at only one height.
Is it possible to add additional extension cables between the Sensor Head and Amplifier Unit?	Regardless of the length, only one extension cable can be added. It is not possible to add multiple extension cables.
About how much signal input and open time is required for each input operation?	These times can be checked using the timing charts in this manual (on page 137).
Can calculations be performed when Sensor Heads that have different measurement ranges are connected to two Amplifier Units?	Yes. This is possible without specifying any special settings.
How can I prevent an incorrect value being measured and output due to the shape of the workpiece?	If the incorrect measurement is caused by multireflection due to the shape of the workpiece, setting the detection surface selection to MAX might improve the measurement accuracy. (See page 116.)

CONTENTS

INTRODUCTION

PREPARATION FOR MEASUREMENT

FLOW OF OPERATION

BASIC SETUP

MAIN APPLICATIONS & SETTING METHODS

Height

Steps and Warpage

Double Sheet Detection

Thickness

Positioning

Eccentricity and Surface Deflection

DETAILED SETTINGS

TROUBLE-SHOOTING

SPECIFICATIONS

INDEX

SETTING TRANSITION CHARTS

CONTENTS

INTRODUCTION

PREPARATION  
FOR  
MEASUREMENT

FLOW OF  
OPERATION

BASIC  
SETUP

MAIN  
APPLICATIONS  
& SETTING  
METHODS

Height

Steps  
and  
Warpage

Double  
Sheet  
Detection

Thickness

Positioning

Eccentricity  
and Surface  
Deflection

DETAILED  
SETTINGS

TROUBLE-  
SHOOTING

SPECIFI-  
CATIONS

INDEX

SETTING  
TRANSITION  
CHARTS

# SPECIFICATIONS

---

<b>Specifications and Dimensions</b>	<b>132</b>
<b>Timing Charts</b>	<b>137</b>
<b>Engineering Data (Typical)</b>	<b>140</b>

# Specifications and Dimensions

## Amplifier Units

ZX2-LDA11/LDA41

(Unit: mm)

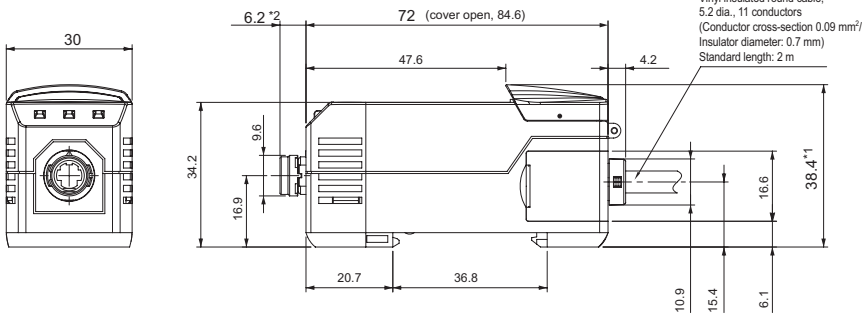
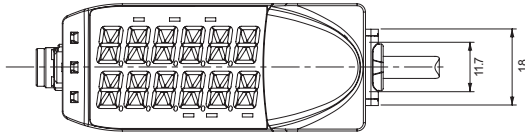

\*1 Max. height when cover is open: 56  
 \*2 Min. length when connected: 50

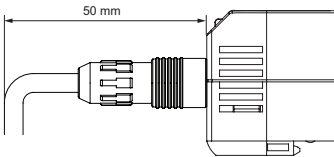

- CONTENTS
- INTRODUCTION
- PREPARATION FOR MEASUREMENT
- FLOW OF OPERATION
- BASIC SETUP
- MAIN APPLICATIONS & SETTING METHODS
- Height
- Steps and Warpage
- Double Sheet Detection
- Thickness
- Positioning
- Eccentricity and Surface Deflection
- DETAILED SETTINGS
- TROUBLE-SHOOTING
- SPECIFICATIONS
- INDEX
- SETTING TRANSITION CHARTS

Item	Model	ZX2-LDA11	ZX2-LDA41
Measurement period (*1)		Min. 30 $\mu$ s	
Response time		60 $\mu$ s, 120 $\mu$ s, 240 $\mu$ s, 500 $\mu$ s, 1 ms, 2 ms, 4 ms, 8 ms, 12 ms, 20 ms, 36 ms, 66 ms, 128 ms, 250 ms, 500 ms	
Analog output (*2)		4 to 20 mA, Max. load resistance: 300 $\Omega$ , $\pm$ 5 VDC or 1 to 5 VDC, Output impedance: 100 $\Omega$	
Judgment outputs (HIGH/PASS/LOW: 3 outputs), error output		NPN open-collector outputs, 30 VDC, 50 mA max. residual voltage: 1 V max. for load current 10 mA max., 2 V max. for load current above 10 mA	PNP open-collector outputs, 30 VDC, 50 mA max. residual voltage: 1 V max. for load current 10 mA max., 2 V max. for load current above 10 mA
Laser OFF input, zero reset input, timing input, reset input, bank input		ON: Short-circuited with 0-V terminal or 1.2 V or less. OFF: Open (leakage current: 0.1 mA max.)	ON: Supply voltage short-circuited or supply voltage within -1.2 V OFF: Open (leakage current: 0.1 mA max.)
Functions		Smart tuning, scaling, sample hold, peak hold, bottom hold, peak-to-peak hold, self-peak hold, self-bottom hold, average hold, zero reset, On-delay timer, OFF-delay timer, keep/clamp switch, (A-B) calculations (*3), thickness calculation (*3), mutual interference prevention (*3), laser deterioration detection, bank function (4 banks)	
Indications		Judgement indicators: HIGH (orange), PASS (green), LOW (orange), 11-segment main display (red), 11-segment sub-display (orange), laser ON (green), zero reset (green), ENABLE (green), MENU (green), HIGH threshold (orange), LOW threshold (orange)	
Power supply voltage		10 to 30 VDC, including 10% ripple(p-p)	
Power consumption		3,000 mW max. with power supply voltage of 30 VDC and power supply current of 100 mA max. (with Sensor connected)	
Ambient temperature		Operating: 0 to +50°C, Storage: -15 to +70°C (with no icing or condensation)	
Ambient humidity		Operating and storage: 35% to 85% (with no condensation)	
Dielectric strength		1,000 VAC, 50/60 Hz for 1 minute	
Vibration resistance (destruction)		10 to 150 Hz, 0.7-mm double amplitude, 80 minutes each in X, Y, and Z directions	
Shock resistance (destruction)		300 m/s <sup>2</sup> 3 times each in six directions (up/down, left/right, forward/backward)	
Degree of protection		IEC60529, IP40	
Connection method		Prewired (standard cable length: 2 m)	
Weight (packed state)		Approx. 200 g (main unit only: approx. 135 g)	
Materials		Case: PBT (polybutylene terephthalate), Cover: Polycarbonate, Display: Acrylic resin, Buttons: Polyacetal, Cable: PVC	
Accessories		Instruction sheet	

(\*1) In the case of a white ceramic OMRON standard object

(\*2) In the MENU mode, select and set current output (4 to 20 mA) and voltage output ( $\pm$ 5 V or 1 to 5 V).

(\*3) A Calculating Unit (ZX2-CAL) is required.

Mutual interference prevention is possible for up to five Amplifier Units, and calculations are possible for up to two.

CONTENTS

INTRODUCTION

PREPARATION FOR MEASUREMENT

FLOW OF OPERATION

BASIC SETUP

MAIN APPLICATIONS &amp; SETTING METHODS

Height

Steps and Warpage

Double Sheet Detection

Thickness

Positioning

Eccentricity and Surface Deflection

DETAILED SETTINGS

TROUBLE-SHOOTING

SPECIFICATIONS

INDEX

SETTING TRANSITION CHARTS

# Sensor Heads

ZX2-LD50/LD50L, ZX2-LD100/LD100L

(Unit: mm)

CONTENTS

INTRODUCTION

PREPARATION FOR MEASUREMENT

FLOW OF OPERATION

BASIC SETUP

MAIN APPLICATIONS & SETTING METHODS

Height

Steps and Warpage

Double Sheet Detection

Thickness

Positioning

Eccentricity and Surface Deflection

DETAILED SETTINGS

TROUBLE-SHOOTING

SPECIFICATIONS

INDEX

SETTING TRANSITION CHARTS

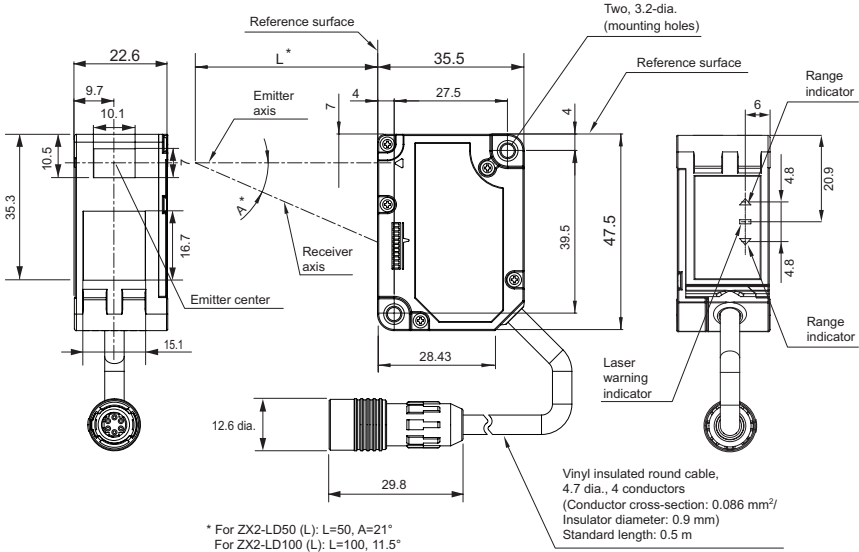
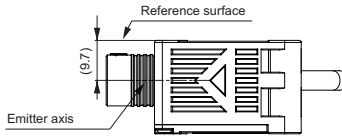

## Sensor Head Extension Cables

ZX2-XC1R, ZX2-XC4R, ZX2-XC9R

(Unit: mm)

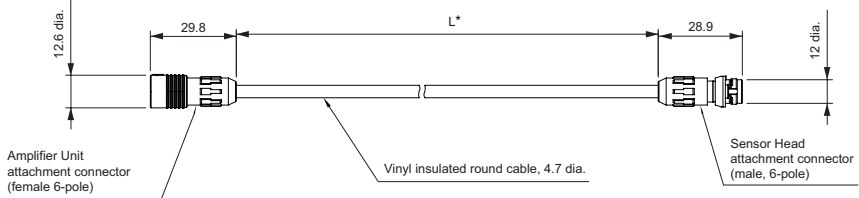

\*L Cable lengths: ZX2-XC1R: 1 m, ZX2-XC4R: 4 m, ZX2-XC9R: 9 m

Note. Two or more extension cables cannot be connected in series.

Item	Model	ZX2-XC1R	ZX2-XC4R	ZX2-XC9R
Cable type		Flex-resistance type		
Degree of protection		IP67		
Dielectric strength (connector)		No flashover and no breakdown at AC 300 V for 1 minute		
Insulation resistance (connector)		1000 MΩ min. (at 100 VDC)		
Weight (packed state)		Approx. 50 g	Approx. 150 g	Approx. 300 g
Materials		Connector: PPS and PBT, Cable: PVC		
Minimum bend radius		30 mm		
Accessories		Ferrite core x 2 (made by TDK Corp. ZCAT1730-0730A)		

Model	ZX2-LD50L	ZX2-LD50	ZX2-LD100L	ZX2-LD100
Optical system	Diffuse reflective			
Light source (wave length)	Visible-light semiconductor laser with a wavelength of 660 nm and an output of 1mW max. EN class 2, FDA class II (*5)			
Measurement center distance	50 mm		100 mm	
Measurement range	±10 mm		±35 mm	
Beam shape	Line	Spot	Line	Spot
Beam size (*1)	Approx. 60 μm x 2.6 mm	Approx. 60 μm dia.	Approx. 110 μm x 2.7 mm	Approx. 110 μm dia.
Resolution (*2)	1.5 μm		5 μm	
Linearity (*3)	±0.05% F.S. (40 to 50 mm)	±0.1% F.S. (40 to 50 mm)	±0.05% F.S. (65 to 100 mm)	±0.1% F.S. (65 to 100 mm)
	±0.1% F.S. (entire range)	±0.15% F.S. (entire range)	±0.1% F.S. (entire range)	±0.15% F.S. (entire range)
Temperature characteristic (*4)	0.02% F.S./°C			
Ambient illumination	Incandescent lamp: 10,000 lx max. (on light receiving side)			
Ambient temperature	Operating: 0 to +50°C, Storage: -15 to +70°C (with no icing or condensation)			
Ambient humidity	Operating and storage: 35% to 85% (with no condensation)			
Dielectric strength	1,000 VAC, 50/60 Hz for 1 minute			
Vibration resistance (destruction)	10 to 150 Hz, 0.7-mm double amplitude, 80 minutes each in X, Y, and Z directions			
Shock resistance (destruction)	300 m/s <sup>2</sup> 3 times each in six directions (up/down, left/right, forward/backward)			
Degree of protection	IEC60529, IP67			
Connection method	Connector connection (standard cable length: 500 mm)			
Weight (packed state)	Approx. 160 g (main unit only: approx. 75 g)			
Materials	Case and cover: PBT (polybutylene terephthalate), Optical window: Glass, Cable: PVC			
Accessories	Instruction sheet, ferrite core x 1 (made by TDK Corp. ZCAT1730-0730A), laser warning label (English), FDA certification label			

(Note) Highly reflective objects can result in incorrect detection by causing out-of-range measurements.

- (\*1) Beam size: The beam size is defined by  $1/e^2$  (13.5%) of the strength of the beam at the beam center (measured value).  
Incorrect detection may occur if there is light leakage outside the defined spot and the material around the sensing object is more reflective than the sensing object.
- (\*2) Resolution: The resolution is the deviation ( $\pm 3\sigma$ ) in the analog output when connected to the ZX2-LDA Amplifier Unit. (The resolution is measured with the standard reference object (white ceramic), at the measurement point when the response time of the ZX2-LDA is set to 128 ms.)  
The resolution is given at the repeat accuracy for a stationary workpiece, and is not an indication of the distance accuracy.  
The resolution may be adversely affected under strong electromagnetic fields.
- (\*3) Linearity: The linearity is given as the error in an ideal straight line displacement output when measuring the standard reference object.  
The linearity and measurement values vary with the object being measured. F.S. is the entire measurement range. (ZX2-LD50□:20mm)
- (\*4) Temperature characteristic: The temperature characteristic is measured at the measurement center distance with the Sensor and reference object (OMRON's standard reference object) secured with an aluminum jig.
- (\*5) Categorized as Class 2 by EN60825-1 criteria in accordance with the stipulations of the FDA standard Laser Notice No.50, and registered with CDRH (Center for Devices and Radiological Health) (accession number: 1020665-000)

# Calculating Unit

ZX2-CAL

(Unit: mm)

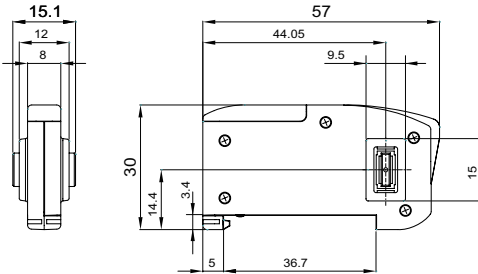
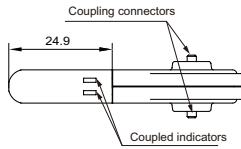

Item	Model	ZX2-CAL
Applicable Amplifier Units		ZX2-LDA11/ZX2-LDA41
Current consumption		12 mA max. (supplied from the Smart Sensor Amplifier Unit)
Ambient temperature		Operating: 0 to +50°C, Storage: -15 to +70°C (with no icing or condensation)
Ambient humidity		Operating and storage: 35% to 85% (with no condensation)
Connection method		Connector
Dielectric strength		1,000 VAC, 50/60 Hz for 1 minute
Vibration resistance (destruction)		10 to 150 Hz, 0.7 mm double amplitude, 80 minutes each in X, Y, and Z directions
Shock resistance (destruction)		300 m/s <sup>2</sup> 3 times each in six directions (up/down, left/right, forward/backward)
Materials		Case: ABS, Display: Acrylic resin
Weight (packed state)		Approx. 50 g (main unit only: approx. 15 g.)
Accessories		Instruction sheet



# Timing Charts

This section explains the timing charts for the I/O signals that are exchanged between the Controller and external devices.

CONTENTS

INTRODUCTION

PREPARATION FOR MEASUREMENT

FLOW OF OPERATION

BASIC SETUP

MAIN APPLICATIONS & SETTING METHODS

Height

Steps and Warpage

Double Sheet Detection

Thickness

Positioning

Eccentricity and Surface Deflection

DETAILED SETTINGS

TROUBLE-SHOOTING

SPECIFICATIONS

INDEX

SETTING TRANSITION CHARTS

## Laser OFF input

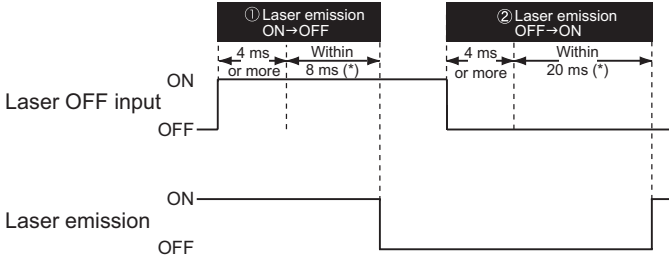

①	<b>Laser emission ON → OFF</b>	If laser OFF input is ON for 4 ms or more, the signal is received, and laser emission is turned OFF within 8 ms.
②	<b>Laser emission OFF → ON</b>	If laser OFF input is OFF for 4 ms or more, the signal is received, and laser emission is turned ON within 20 ms.

(\*) The value is within 150 ms when mutual interference prevention is set to ON.

## Reset input

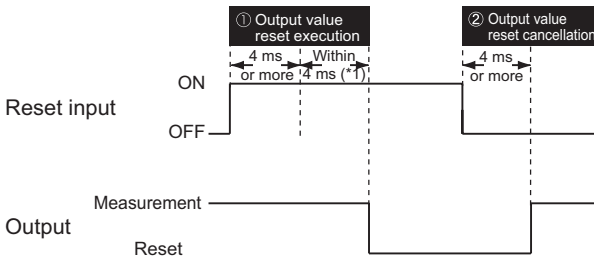

①	<b>Output value reset execution</b>	If reset input is ON for 4 ms or more, the signal is received, and output is reset within 4 ms.
②	<b>Output value reset cancellation</b>	If reset input is OFF for 4 ms or more, measurement is resumed. Acquire the measurement results after the preset response time elapses. (*2)

(\*1) The value is within 150 ms when mutual interference prevention is set to ON.

(\*2) When connecting two or more Amplifier Units, acquire the measurement results after the response time specified for connecting two or more units elapses. (See page 82.)

## Bank input

- When only one Amplifier Unit is used

Example: Switching from bank 2 to bank 1

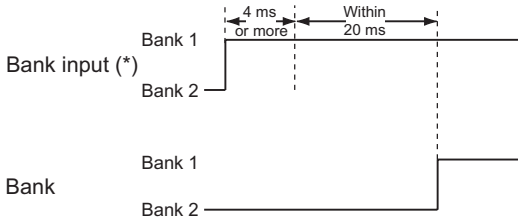

(\*) Bank input is executed by the ON/OFF combinations of BANK input 0 and BANK input 1.

If a bank input signal is input for 4 ms or more, the bank is determined, the bank is switched within 20 ms, and then measurement is resumed.

Acquire the measurement results after the preset response time elapses.

- When connecting two or more Amplifier Units

Example: Switching from bank 2 to bank 1

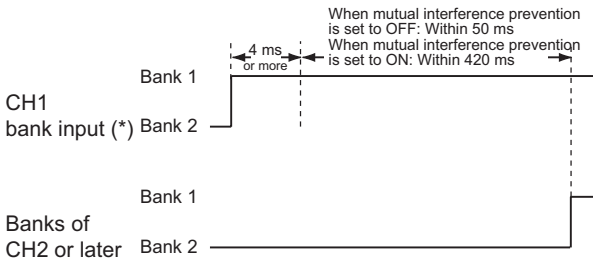

(\*) Bank input is executed by the ON/OFF combinations of CH1 BANK input 0 and CH1 BANK input 1 when connecting two or more Amplifier Units.

If a CH1 bank input signal is input for 4 ms or more, the bank is determined, the bank is switched within 50 ms if mutual interference prevention is set to OFF, and within 420 ms if mutual interference prevention is set to ON, and then measurement is resumed.

Acquire the measurement results after the response time specified for connecting two or more Amplifier Units elapses. (See page 82.)

## Zero reset input

- When the zero reset memory setting is OFF

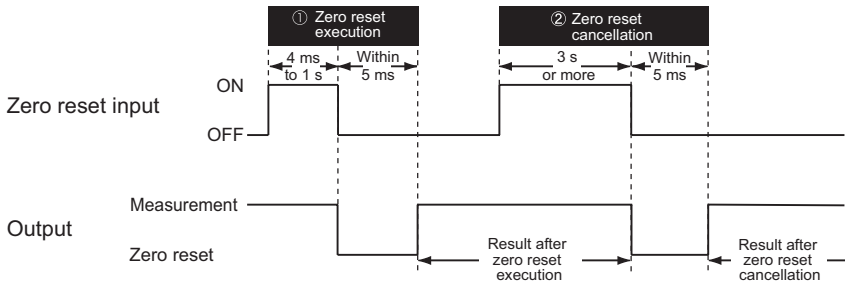

①	<b>Zero reset execution</b>	Turn OFF after 4 ms to 1 s zero reset input turns ON. The zero reset is executed, and measurement is resumed within 5 ms. Acquire the measurement results after the preset response time elapses. (*)
②	<b>Zero reset cancellation</b>	Turn OFF after zero reset input turns ON for 3 s or more. The zero reset is canceled, and measurement is resumed within 5 ms. Acquire the measurement results after the preset response time elapses. (*)

- When the zero reset memory setting is ON

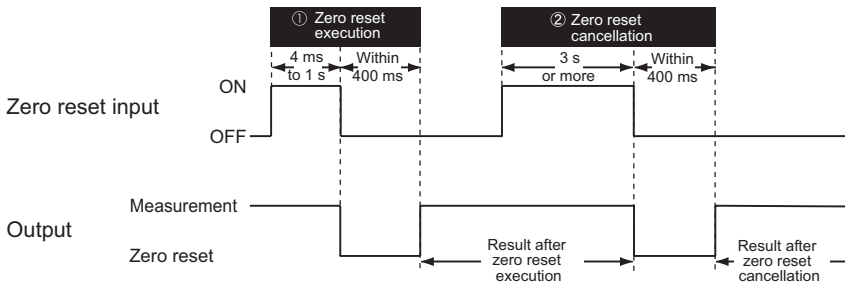

①	<b>Zero reset execution</b>	Turn OFF after 4 ms to 1 s zero reset input turns ON. The zero reset is executed, and measurement is resumed within 400 ms. Acquire the measurement results after the preset response time elapses. (*)
②	<b>Zero reset cancellation</b>	Turn OFF after zero reset input turns ON for 3 s or more. The zero reset is canceled, and measurement is resumed within 400 ms. Acquire the measurement results after the preset response time elapses. (*)

(\*) When connecting two or more Amplifier Units, acquire the measurement results after the response time specified for connecting two or more units elapses. (See page 82.)

CONTENTS

INTRODUCTION

PREPARATION FOR MEASUREMENT

FLOW OF OPERATION

BASIC SETUP

MAIN APPLICATIONS & SETTING METHODS

Height

Steps and Warpage

Double Sheet Detection

Thickness

Positioning

Eccentricity and Surface Deflection

DETAILED SETTINGS

TROUBLE-SHOOTING

SPECIFICATIONS

INDEX

SETTING TRANSITION CHARTS

# Engineering Data (Typical)

## Angle Characteristic

The angle characteristic is a plot of the inclination of the sensing object in the measurement range and the maximum value of the error to analog output.

Note: SUS304 = Stainless steel SUS304

### ZX2-LD50

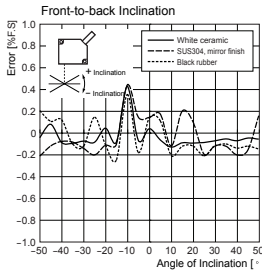
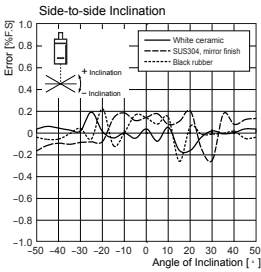

### ZX2-LD50L

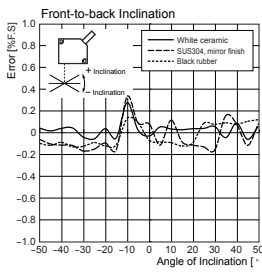
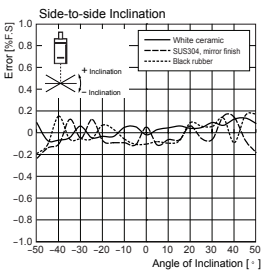

### ZX2-LD100

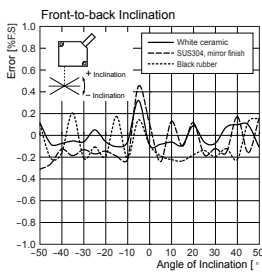
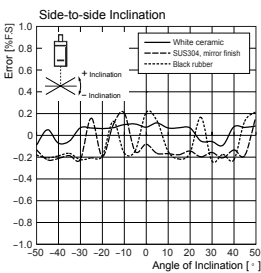

### ZX2-LD100L

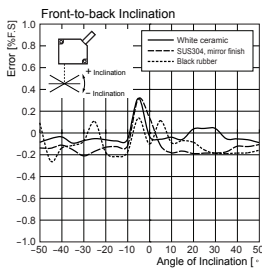
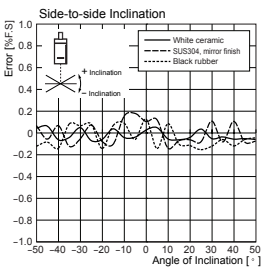

# Linearity Characteristic for Different Materials

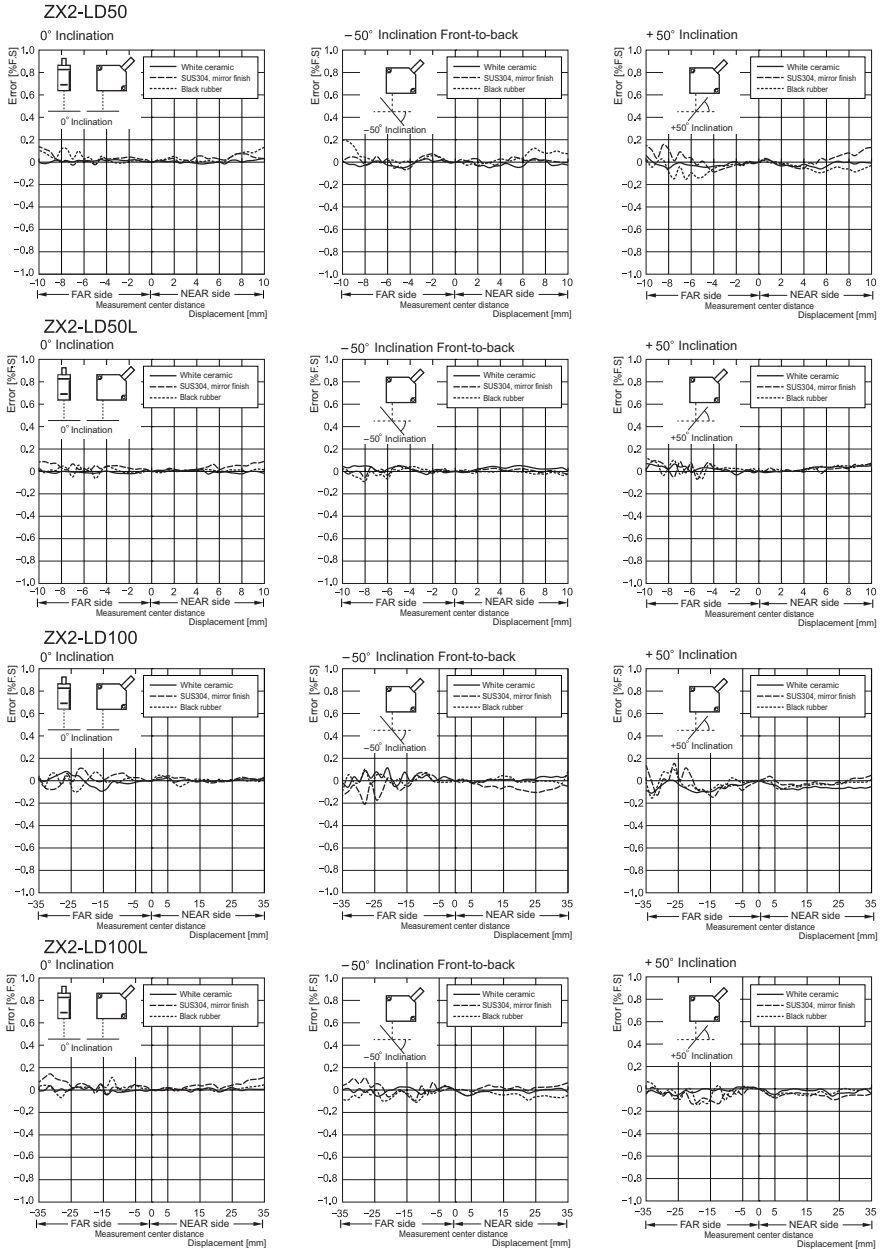

Note. X axis displacement: Measurement distance displayed on the Amplifier Unit  
 For the measurement distance displayed on the Amplifier Unit, the measurement center distance is displayed as 0,  
 and the NEAR and FAR sides from the sensor are displayed by + and -, respectively.

CONTENTS

INTRODUCTION

PREPARATION FOR MEASUREMENT

FLOW OF OPERATION

BASIC SETUP

MAIN APPLICATIONS & SETTING METHODS

Height

Steps and Warpage

Double Sheet Detection

Thickness

Positioning

Eccentricity and Surface Deflection

DETAILED SETTINGS

TROUBLE-SHOOTING

SPECIFICATIONS

INDEX

SETTING TRANSITION CHARTS

# Beam Size

## ■ Spot Beams

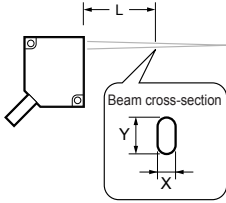

ZX2-LD50

L	+10 mm	0 mm	-4 mm	-10 mm
X	Approx. 600 $\mu$ m	Approx. 160 $\mu$ m	Approx. 40 $\mu$ m	Approx. 220 $\mu$ m
Y	Approx. 350 $\mu$ m	Approx. 90 $\mu$ m	Approx. 60 $\mu$ m	Approx. 130 $\mu$ m

ZX2-LD100

L	+35 mm	0 mm	-20 mm	-35 mm
X	Approx. 1.1 mm	Approx. 400 $\mu$ m	Approx. 70 $\mu$ m	Approx. 250 $\mu$ m
Y	Approx. 550 $\mu$ m	Approx. 190 $\mu$ m	Approx. 110 $\mu$ m	Approx. 150 $\mu$ m

## ■ Line Beams

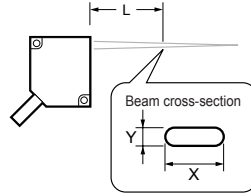

ZX2-LD50L

L	+10 mm	0 mm	-4 mm	-10 mm
X	Approx. 2.6 mm	Approx. 2.6 mm	Approx. 2.6 mm	Approx. 2.6 mm
Y	Approx. 350 $\mu$ m	Approx. 90 $\mu$ m	Approx. 60 $\mu$ m	Approx. 130 $\mu$ m

ZX2-LD100L

L	+35 mm	0 mm	-20 mm	-35 mm
X	Approx. 2.1 mm	Approx. 2.5 mm	Approx. 2.7 mm	Approx. 2.9 mm
Y	Approx. 550 $\mu$ m	Approx. 190 $\mu$ m	Approx. 110 $\mu$ m	Approx. 150 $\mu$ m

Note. L: Measurement distance displayed on the Amplifier Unit (For the measurement distance displayed on the Amplifier Unit, the measurement center distance is displayed as 0, and the NEAR and FAR sides from the sensor are displayed by + and -, respectively.)

CONTENTS

INTRODUCTION

PREPARATION FOR MEASUREMENT

FLOW OF OPERATION

BASIC SETUP

MAIN APPLICATIONS & SETTING METHODS

Height

Steps and Warpage

Double Sheet Detection

Thickness

Positioning

Eccentricity and Surface Deflection

DETAILED SETTINGS

TROUBLE-SHOOTING

SPECIFICATIONS

INDEX

SETTING TRANSITION CHARTS

# INDEX

## Numerics

1.5V (analog output 1 to 5 V)	105
2-sensor operation (thickness)	58
2-sensor operation (A-B)	48
4.20mA (analog output 4 to 20 mA)	105
-5.5V (analog output ±5 V)	105

## A

A-B (2-sensor operation A-B)	48
Active Smart Tuning	81
Amplifier Unit	
Connecting the Sensor Head to the Amplifier Unit	27
Connecting Two or More Amplifier Units	82
Installing	24
Part Names and Functions	19
Specifications and Dimensions	132
Analog Output	105
Angle Characteristic	140
A-OUT (analog output)	105
AVE (hold measured value average)	42, 52, 60, 74, 90

## B

BANK (bank switching)	96, 115
Bank Setting	95
Bank Switching	96, 115
Basic Configuration	18
BASIC SETUP	38
Beam Size	135, 142
AVE (hold minimum value)	42, 52, 60, 74, 90

## C

CLAMP (2-sensor operation)	48, 58
Calculating Unit	
Connecting	25
Part Names and Functions	22

Specifications and Dimensions	136
Canceling the Key Lock	118
CLAMP (output for non-measurement clamp/clamp value)	108
Clamp value	108
Connecting	
Calculating Unit	25
Sensor Head and Amplifier Unit	27
Connecting the Sensor Head to the Amplifier Unit	27

## D

Default Settings	119
Default Value	119
DETAIL (detail menu display)	
40, 46, 50, 56, 64, 70, 84, 87, 89, 95, 98, 101, 107, 110, 112, 114, 116	
DETECT	116
DIFF	112
Display of RUN Mode	38
Double Sheet Detection	50

## E

E-BRGD	125, 126
E-CH	126
E-DARK	126
E-HEAD	126, 127
E-MEM	127
Engineering Data (Typical)	
Angle Characteristic	140
Beam Size	142
Linearity Characteristic for Different Materials	141
Error Messages	126
E-SHRT	127
E-SYS	127
External Input	114
EXT-IN (external input)	114

CONTENTS

INTRODUCTION

PREPARATION FOR MEASUREMENT

FLOW OF OPERATION

BASIC SETUP

MAIN APPLICATIONS & SETTING METHODS

Height

Steps and Warpage

Double Sheet Detection

Thickness

Positioning

Eccentricity and Surface Deflection

DETAILED SETTINGS

TROUBLE-SHOOTING

SPECIFICATIONS

INDEX

SETTING TRANSITION CHARTS

<b>F</b>		
	FIRST (detection surface selection FIRST)	116
	FLOW OF OPERATION	34

<b>H</b>		
	Hold	42, 52, 60, 73, 89
	<i>HOLD</i> (hold)	42, 52, 60, 73, 90
	<i>HYS</i> (hysteresis width)	88
	Hysteresis	87

<b>I</b>		
	I/O Circuit Diagrams	
	PNP Amplifier Unit	32
	<i>INIT</i> (initialization)	120
	Initialization	119
	Installing	
	Amplifier Unit	24
	Sensor Head	23

<b>K</b>		
	<i>KEEP</i> (output for non-measurement keep)	108
	Key Lock Function	118
	<i>K-LOCK</i> (key lock enabled)	118

<b>L</b>		
	<i>Lddown</i>	128
	LD-OFF input	29
	Linearity Characteristic for Different Materials	141

<b>M</b>		
	Main Display	19, 20
	<i>MAX</i> (clamp value MAX)	108
	<i>MAX</i> (detection surface selection MAX)	116
	Measuring Eccentricity and Surface Deflection	70
	Measuring Height	40
	Measuring Thickness	55
	Multi Smart Tuning	80
	Mutual Interference Prevention	46, 56, 84

<b>N</b>		
	I/O Circuit Diagrams	
	NPN Amplifier Unit	31

<b>O</b>		
	OFF-delay timer	110
	<i>OFF-EM</i> (OFF-delay timer)	110
	ON-delay timer	110
	<i>ON-EM</i> (ON-delay timer)	110
	Output for Non-measurement	107

<b>P</b>		
	Part Names and Functions	18
	Amplifier Unit	19
	Calculating Unit	22
	Sensor Head	22
	<i>PEAK</i> (hold peak)	42, 52, 60, 74, 90
	Positioning	64
	PREPARATION FOR MEASUREMENT	17
	<i>PEP</i> (hold peak-to-peak)	42, 52, 60, 74, 90

<b>Q</b>		
	Q&A	129

<b>R</b>		
	Reset Input	115
	Reset input	30
	Response time	46, 51, 56, 65, 71, 78
	<i>RESET</i> (output for non-measurement)	108

<b>S</b>		
	<i>S1-AFT</i> (scaling S1-Aft)	67, 72, 102, 103
	<i>S1-BEF</i> (scaling S1-Bef)	67, 72, 102, 103
	<i>S2-AFT</i> (scaling S2-Aft)	68, 73, 103
	<i>S2-BEF</i> (scaling S2-Bef)	68, 73, 103
	<i>SAMPLE</i> (hold sample)	42, 52, 60, 74, 90
	<i>SCALE</i> (scaling)	66, 72, 101
	Scaling	66, 72, 101
	<i>SELF-d</i> (self-trigger self-d)	43, 53, 61, 75, 92



<i>SELF LV</i> (self-trigger level)	43, 53, 61, 75, 93
<i>SELF-U</i> (self-trigger self-u)	43, 53, 61, 75, 92
Sensor Head	
Part Names and Functions	22
Specifications and Dimensions	134
Sensor Head extension cable	134
Sensor Heads: Installing	23
Setting Transition Charts	148
Simplest Setting	38
Single Smart Tuning	38, 41, 47, 51, 57, 66, 71, 79
Smart Tuning	38, 41, 47, 51, 57, 66, 71, 78
<i>SMART/ACCI VE</i>	81
<i>SMART/MULTEI</i>	80
<i>SMART/SINGLE</i>	38, 41, 47, 51, 57, 66, 71, 79
Specifications and Dimensions	
Amplifier Unit	132
Calculating Unit	136
Sensor Head	134
<i>SPEED</i> (response time)	41, 46, 51, 56, 65, 71, 78
Steps and Warpage	45
Sub-display	19, 20
<i>SYNC</i> (mutual interference prevention)	46, 56, 85

## T

<i>THICK</i> (2-sensor operation thickness)	58
Threshold Setting	44, 48, 54, 62, 69, 76
Timer	110
<i>TIMING</i> (self-trigger timing input)	43, 53, 61, 75, 92
Timing Charts	137
Timing input	93, 115
<i>TIMRSE</i> (timing input/reset input)	115

<i>TRIG</i> (self-trigger)	42, 52, 61, 74, 92
Troubleshooting	124
<i>UNIT/MULTEI</i>	80
<i>UNIT/SINGLE</i>	38, 41, 47, 51, 57, 66, 71, 79

## W

Wiring Diagram	28
Wiring Input/Output Cables	28

## Z

Zero Reset	97
Zero reset cancellation	100
<i>ZRDISP</i> (display setting at zero reset)	99
<i>ZRMEM</i> (zero reset memory)	98

CONTENTS

INTRODUCTION

PREPARATION FOR MEASUREMENT

FLOW OF OPERATION

BASIC SETUP

MAIN APPLICATIONS & SETTING METHODS

Height

Steps and Warpage

Double Sheet Detection

Thickness

Positioning

Eccentricity and Surface Deflection

DETAILED SETTINGS

TROUBLE-SHOOTING

SPECIFICATIONS

INDEX

SETTING TRANSITION CHARTS

CONTENTS

INTRODUCTION

PREPARATION  
FOR  
MEASUREMENT

FLOW OF  
OPERATION

BASIC  
SETUP

MAIN  
APPLICATIONS  
& SETTING  
METHODS

Height

Steps  
and  
Warpage

Double  
Sheet  
Detection

Thickness

Positioning

Eccentricity  
and Surface  
Deflection

DETAILED  
SETTINGS

TROUBLE-  
SHOOTING

SPECIFI-  
CATIONS

INDEX

SETTING  
TRANSITION  
CHARTS

# Revision History

A manual revision code appears as a suffix to the catalog number at the bottom of the front and back covers of this manual.

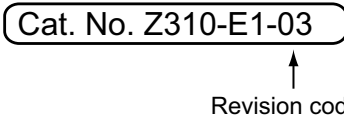

Revision code	Date	Revised contents
01	Oct. 2010	Original production
02	Jan. 2011	General revision
03	Apr. 2011	General revision

# SETTING TRANSITION CHARTS

- CONTENTS
- INTRODUCTION
- PREPARATION FOR MEASUREMENT
- FLOW OF OPERATION
- BASIC SETUP
- MAIN APPLICATIONS & SETTING METHODS
- Height
- Steps and Warpage
- Double Sheet Detection
- Thickness
- Positioning
- Eccentricity and Surface Deflection
- DETAILED SETTINGS
- TROUBLE-SHOOTING
- SPECIFICATIONS
- INDEX
- SETTING TRANSITION CHARTS

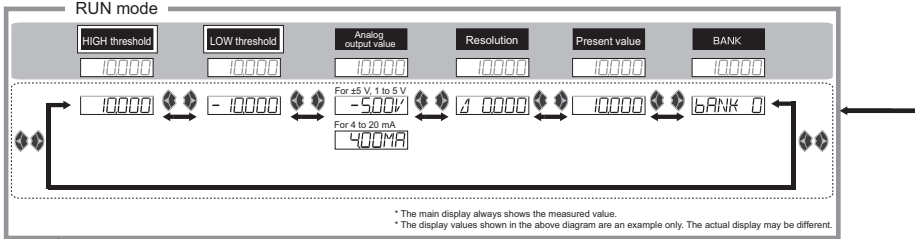

**MENU mode**  
 When the detail menu is enabled

**MENU/SET**  
 Hold down for 3 seconds.

MENU mode → RUN mode  
 When the mode is switched, the system returns to the display specified before the MENU mode switch.

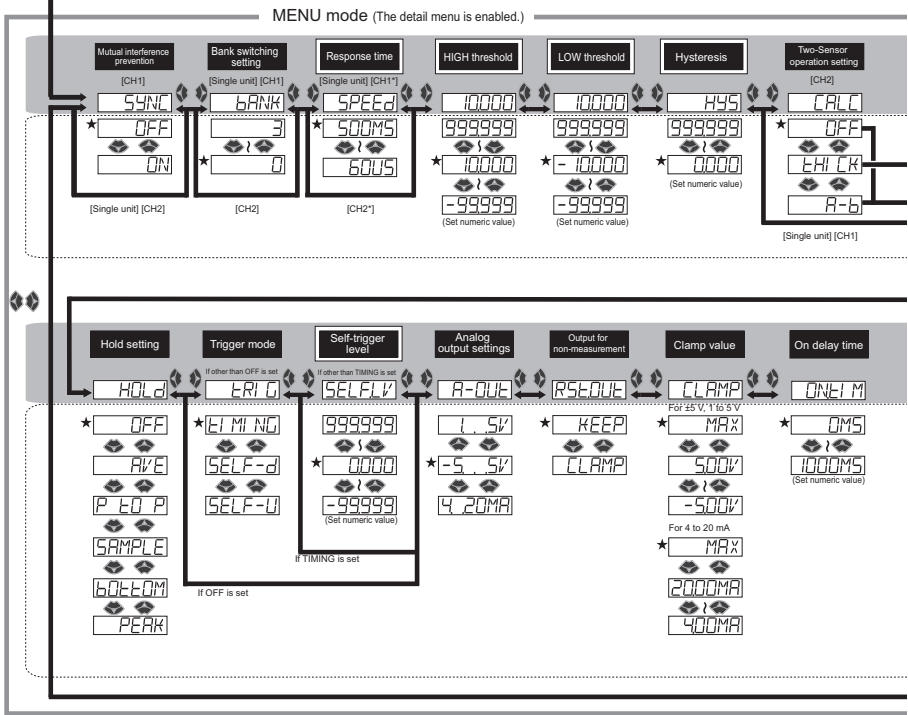
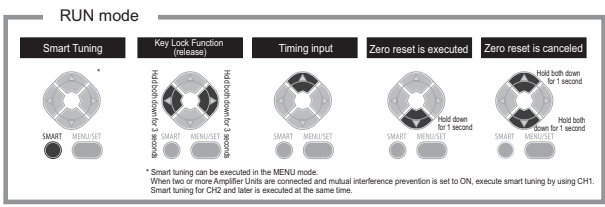

█ : Bank switching    ★ : Default Value\*    █ : Main Display    ▭ : Sub-display

\* The default threshold and scaling values in the figure assume those for ZX2-LD50(L).

[Single unit]: Only one amplifier unit is used  
 [CH1]: Amplifier unit CH1 among connected units  
 [CH2]: Amplifier unit CH2 or later among connected units  
 [CH1\*]: Amplifier unit CH1 among connected units with mutual interference prevention on  
 [CH2\*]: Amplifier unit CH2 or later among connected units with mutual interference prevention on

**MENU mode (The detail menu is disabled.)**

- When used for the first time
- MENU mode: When the detail menu is disabled

**MENU/SET**

Hold down for 3 seconds.

MENU mode → RUN mode: When the mode is switched, the system returns to the display specified before the MENU mode switch.

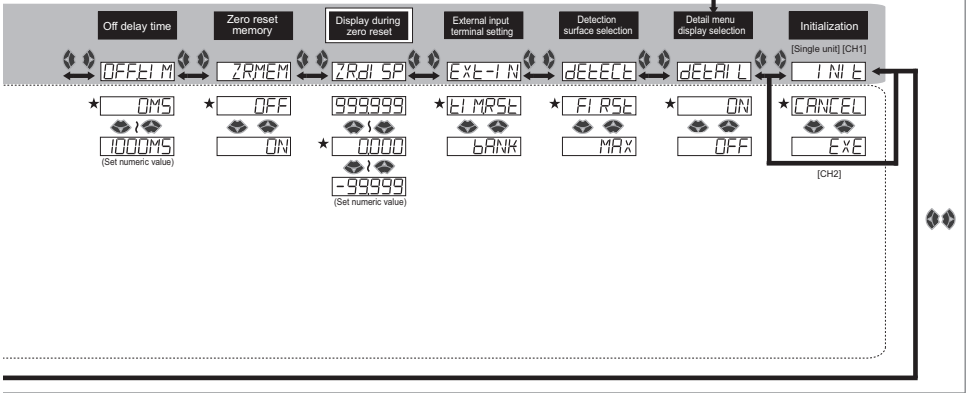
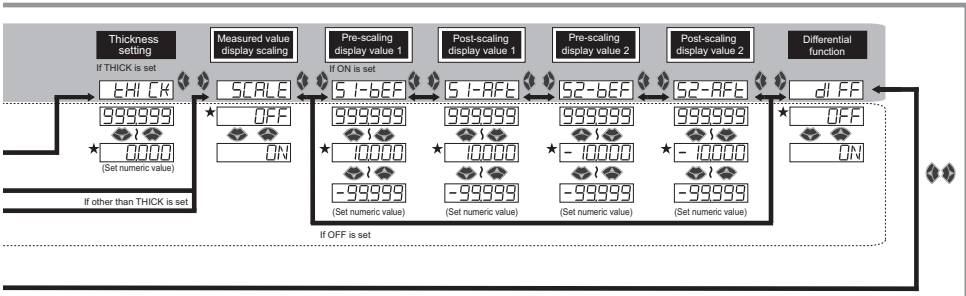
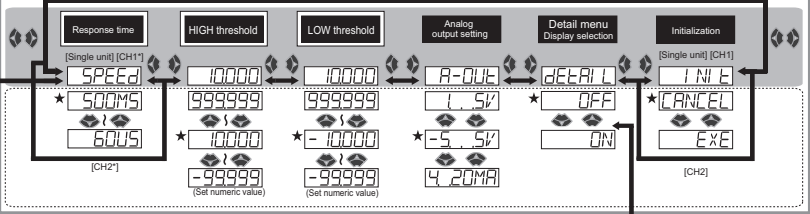

**CONTENTS**

**INTRODUCTION**

**PREPARATION FOR MEASUREMENT**

**FLOW OF OPERATION**

**BASIC SETUP**

**MAIN APPLICATIONS & SETTING METHODS**

**Height**

**Steps and Warpage**

**Double Sheet Detection**

**Thickness**

**Positioning**

**Eccentricity and Surface Deflection**

**DETAILED SETTINGS**

**TROUBLE-SHOOTING**

**SPECIFICATIONS**

**INDEX**

**SETTING TRANSITION CHARTS**



# Terms and Conditions of Sale

1. **Offer; Acceptance.** These terms and conditions (these "**Terms**") are deemed part of all quotes, agreements, purchase orders, acknowledgments, price lists, catalogs, manuals, brochures and other documents, whether electronic or in writing, relating to the sale of products or services (collectively, the "**Products**") by Omron Electronics LLC and its subsidiary companies ("**Omron**"). Omron objects to any terms or conditions proposed in Buyer's purchase order or other documents which are inconsistent with, or in addition to, these Terms.
2. **Prices; Payment Terms.** All prices stated are current, subject to change without notice by Omron. Omron reserves the right to increase or decrease prices on any unshipped portions of outstanding orders. Payments for Products are due net 30 days unless otherwise stated in the invoice.
3. **Discounts.** Cash discounts, if any, will apply only on the net amount of invoices sent to Buyer after deducting transportation charges, taxes and duties, and will be allowed only if (i) the invoice is paid according to Omron's payment terms and (ii) Buyer has no past due amounts.
4. **Interest.** Omron, at its option, may charge Buyer 1-1/2% interest per month or the maximum legal rate, whichever is less, on any balance not paid within the stated terms.
5. **Orders.** Omron will accept no order less than \$200 net billing.
6. **Governmental Approvals.** Buyer shall be responsible for, and shall bear all costs involved in, obtaining any government approvals required for the importation or sale of the Products.
7. **Taxes.** All taxes, duties and other governmental charges (other than general real property and income taxes), including any interest or penalties thereon, imposed directly or indirectly on Omron or required to be collected directly or indirectly by Omron for the manufacture, production, sale, delivery, importation, consumption or use of the Products sold hereunder (including customs duties and sales, excise, use, turnover and license taxes) shall be charged to and remitted by Buyer to Omron.
8. **Financial.** If the financial position of Buyer at any time becomes unsatisfactory to Omron, Omron reserves the right to stop shipments or require satisfactory security or payment in advance. If Buyer fails to make payment or otherwise comply with these Terms or any related agreement, Omron may (without liability and in addition to other remedies) cancel any unshipped portion of Products sold hereunder and stop any Products in transit until Buyer pays all amounts, including amounts payable hereunder, whether or not then due, which are owing to it by Buyer. Buyer shall in any event remain liable for all unpaid accounts.
9. **Cancellation; Etc.** Orders are not subject to rescheduling or cancellation unless Buyer indemnifies Omron against all related costs or expenses.
10. **Force Majeure.** Omron shall not be liable for any delay or failure in delivery resulting from causes beyond its control, including earthquakes, fires, floods, strikes or other labor disputes, shortage of labor or materials, accidents to machinery, acts of sabotage, riots, delay in or lack of transportation or the requirements of any government authority.
11. **Shipping; Delivery.** Unless otherwise expressly agreed in writing by Omron:
  - a. Shipments shall be by a carrier selected by Omron; Omron will not drop ship except in "break down" situations.
  - b. Such carrier shall act as the agent of Buyer and delivery to such carrier shall constitute delivery to Buyer;
  - c. All sales and shipments of Products shall be FOB shipping point (unless otherwise stated in writing by Omron), at which point title and risk of loss shall pass from Omron to Buyer; provided that Omron shall retain a security interest in the Products until the full purchase price is paid;
  - d. Delivery and shipping dates are estimates only; and
  - e. Omron will package Products as it deems proper for protection against normal handling and extra charges apply to special conditions.
12. **Claims.** Any claim by Buyer against Omron for shortage or damage to the Products occurring before delivery to the carrier must be presented in writing to Omron within 30 days of receipt of shipment and include the original transportation bill signed by the carrier noting that the carrier received the Products from Omron in the condition claimed.
13. **Warranties.** (a) **Exclusive Warranty.** Omron's exclusive warranty is that the Products will be free from defects in materials and workmanship for a period of twelve months from the date of sale by Omron (or such other period expressed in writing by Omron). Omron disclaims all other warranties, express or implied. (b) **Limitations.** OMRON MAKES NO WARRANTY OR REPRESENTATION, EXPRESS OR IMPLIED, ABOUT NON-INFRINGEMENT, MERCHANTABILITY OR FITNESS FOR A PARTICULAR PURPOSE OF THE PRODUCTS. BUYER ACKNOWLEDGES THAT IT ALONE HAS DETERMINED THAT THE PRODUCTS WILL SUITABLY MEET THE REQUIREMENTS OF THEIR INTENDED USE. Omron further disclaims all warranties and responsibility of any type for claims or expenses based on infringement by the Products or otherwise of any intellectual property right. (c) **Buyer Remedy.** Omron's sole obligation hereunder shall be, at Omron's election, to (i) replace (in the form originally shipped with Buyer responsible for labor charges for removal or replacement thereof) the non-complying Product, (ii) repair the non-complying Product, or (iii) repay or credit Buyer an amount equal to the purchase price of the non-complying Product; provided that in no event shall Omron be responsible for warranty, repair, indemnity or any other claims or expenses regarding the Products unless Omron's analysis confirms that the Products were properly handled, stored, installed and maintained and not subject to contamination, abuse, misuse or inappropriate modification. Return of any Products by Buyer must be approved in writing by Omron before shipment. Omron Companies shall not be liable for the suitability or unsuitability or the results from the use of Products in combination with any electrical or electronic components, circuits, system assemblies or any other materials or substances or environments. Any advice, recommendations or information given orally or in writing, are not to be construed as an amendment or addition to the above warranty. See <http://www.omron247.com> or contact your Omron representative for published information.
14. **Limitation on Liability; Etc.** OMRON COMPANIES SHALL NOT BE LIABLE FOR SPECIAL, INDIRECT, INCIDENTAL, OR CONSEQUENTIAL DAMAGES, LOSS OF PROFITS OR PRODUCTION OR COMMERCIAL LOSS IN ANY WAY CONNECTED WITH THE PRODUCTS, WHETHER SUCH CLAIM IS BASED IN CONTRACT, WARRANTY, NEGLIGENCE OR STRICT LIABILITY. Further, in no event shall liability of Omron Companies exceed the individual price of the Product on which liability is asserted.
15. **Indemnities.** Buyer shall indemnify and hold harmless Omron Companies and their employees from and against all liabilities, losses, claims, costs and expenses (including attorney's fees and expenses) related to any claim, investigation, litigation or proceeding (whether or not Omron is a party) which arises or is alleged to arise from Buyer's acts or omissions under these Terms or in any way with respect to the Products. Without limiting the foregoing, Buyer (at its own expense) shall indemnify and hold harmless Omron and defend or settle any action brought against such Companies to the extent based on a claim that any Product made to Buyer specifications infringed intellectual property rights of another party.
16. **Property; Confidentiality.** Any intellectual property in the Products is the exclusive property of Omron Companies and Buyer shall not attempt to duplicate it in any way without the written permission of Omron. Notwithstanding any charges to Buyer for engineering or tooling, all engineering and tooling shall remain the exclusive property of Omron. All information and materials supplied by Omron to Buyer relating to the Products are confidential and proprietary, and Buyer shall limit distribution thereof to its trusted employees and strictly prevent disclosure to any third party.
17. **Export Controls.** Buyer shall comply with all applicable laws, regulations and licenses regarding (i) export of products or information; (ii) sale of products to "forbidden" or other proscribed persons; and (iii) disclosure to non-citizens of regulated technology or information.
18. **Miscellaneous.** (a) **Waiver.** No failure or delay by Omron in exercising any right and no course of dealing between Buyer and Omron shall operate as a waiver of rights by Omron. (b) **Assignment.** Buyer may not assign its rights hereunder without Omron's written consent. (c) **Law.** These Terms are governed by the law of the jurisdiction of the home office of the Omron company from which Buyer is purchasing the Products (without regard to conflict of law principles). (d) **Amendment.** These Terms constitute the entire agreement between Buyer and Omron relating to the Products, and no provision may be changed or waived unless in writing signed by the parties. (e) **Severability.** If any provision hereof is rendered ineffective or invalid, such provision shall not invalidate any other provision. (f) **Setoff.** Buyer shall have no right to set off any amounts against the amount owing in respect of this invoice. (g) **Definitions.** As used herein, "including" means "including without limitation"; and "Omron Companies" (or similar words) mean Omron Corporation and any direct or indirect subsidiary or affiliate thereof.

## Certain Precautions on Specifications and Use

1. **Suitability of Use.** Omron Companies shall not be responsible for conformity with any standards, codes or regulations which apply to the combination of the Product in the Buyer's application or use of the Product. At Buyer's request, Omron will provide applicable third party certification documents identifying ratings and limitations of use which apply to the Product. This information by itself is not sufficient for a complete determination of the suitability of the Product in combination with the end product, machine, system, or other application or use. Buyer shall be solely responsible for determining appropriateness of the particular Product with respect to Buyer's application, product or system. Buyer shall take application responsibility in all cases but the following is a non-exhaustive list of applications for which particular attention must be given: (i) Outdoor use, uses involving potential chemical contamination or electrical interference, or conditions or uses not described in this document. (ii) Use in consumer products or any use in significant quantities. (iii) Energy control systems, combustion systems, railroad systems, aviation systems, medical equipment, amusement machines, vehicles, safety equipment, and installations subject to separate industry or government regulations. (iv) Systems, machines and equipment that could present a risk to life or property. Please know and observe all prohibitions of use applicable to this Product. NEVER USE THE PRODUCT FOR AN APPLICATION INVOLVING SERIOUS RISK TO LIFE OR PROPERTY OR IN LARGE QUANTITIES WITHOUT ENSURING THAT THE SYSTEM AS A WHOLE HAS BEEN DESIGNED TO ADDRESS THE RISKS, AND THAT THE OMRON'S PRODUCT IS PROPERLY RATED AND INSTALLED FOR THE INTENDED USE WITHIN THE OVERALL EQUIPMENT OR SYSTEM.
2. **Programmable Products.** Omron Companies shall not be responsible for the user's programming of a programmable Product, or any consequence thereof.
3. **Performance Data.** Data presented in Omron Company websites, catalogs and other materials is provided as a guide for the user in determining suitability and does not constitute a warranty. It may represent the result of Omron's test conditions, and the user must correlate it to actual application requirements. Actual performance is subject to the Omron's Warranty and Limitations of Liability.
4. **Change in Specifications.** Product specifications and accessories may be changed at any time based on improvements and other reasons. It is our practice to change part numbers when published ratings or features are changed, or when significant construction changes are made. However, some specifications of the Product may be changed without any notice. When in doubt, special part numbers may be assigned to fix or establish key specifications for your application. Please consult with your Omron's representative at any time to confirm actual specifications of purchased Product.
5. **Errors and Omissions.** Information presented by Omron Companies has been checked and is believed to be accurate; however, no responsibility is assumed for clerical, typographical or proofreading errors or omissions.



---

**OMRON INDUSTRIAL AUTOMATION • THE AMERICAS HEADQUARTERS**

Schaumburg, IL USA • 847.843.7900 • 800.556.6766 • [www.omron247.com](http://www.omron247.com)

**OMRON CANADA, INC. • HEAD OFFICE**

Toronto, ON, Canada • 416.286.6465 • 866.986.6766 • [www.omron247.com](http://www.omron247.com)

**OMRON ELECTRONICS DE MEXICO • HEAD OFFICE**

México DF • 52.55.59.01.43.00 • 001.800.556.6766 • [mela@omron.com](mailto:mela@omron.com)

**OMRON ELECTRONICS DE MEXICO • SALES OFFICE**

Apodaca, N.L. • 52.81.11.56.99.20 • 001.800.556.6766 • [mela@omron.com](mailto:mela@omron.com)

**OMRON ELETRÔNICA DO BRASIL LTDA • HEAD OFFICE**

São Paulo, SP, Brasil • 55.11.2101.6300 • [www.omron.com.br](http://www.omron.com.br)

**OMRON ARGENTINA • SALES OFFICE**

Cono Sur • 54.11.4783.5300

**OMRON CHILE • SALES OFFICE**

Santiago • 56.9.9917.3920

**OTHER OMRON LATIN AMERICA SALES**

54.11.4783.5300

---

**OMRON EUROPE B.V.** • Wegalaan 67-69, NL-2132 JD, Hoofddorp, The Netherlands. • Tel: +31 (0) 23 568 13 00

Fax: +31 (0) 23 568 13 88 • [www.industrial.omron.eu](http://www.industrial.omron.eu)