

Mechanical Dimensions: Inches [mm]

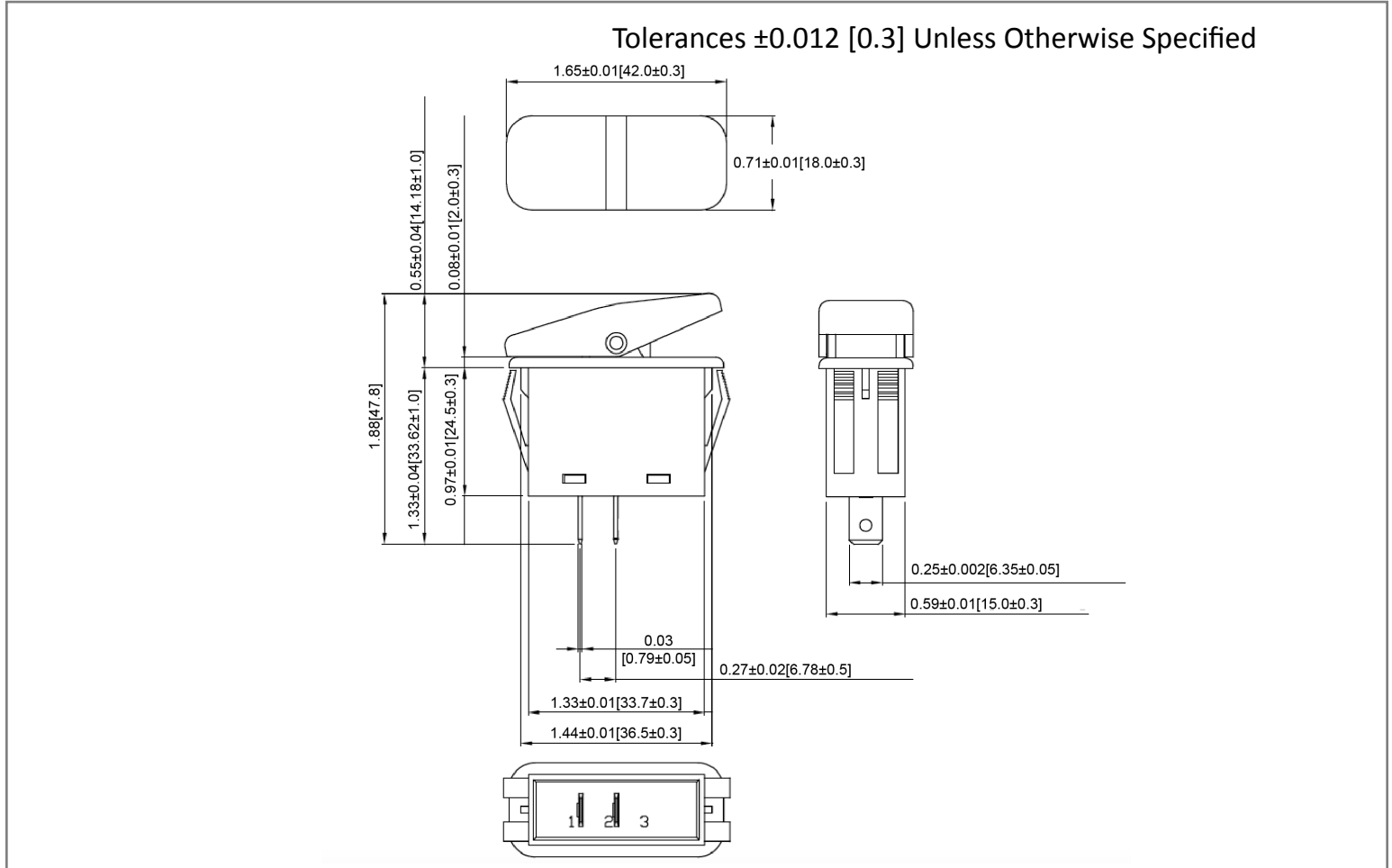

Mounting Hole

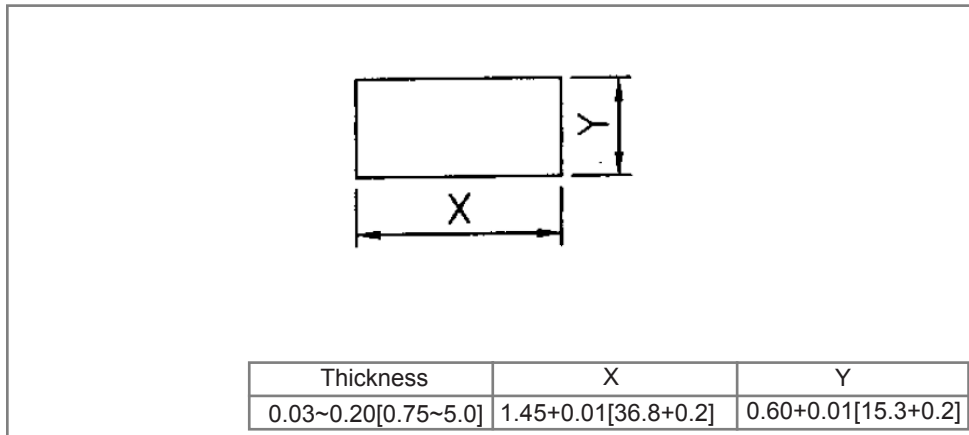

Circuit Diagram

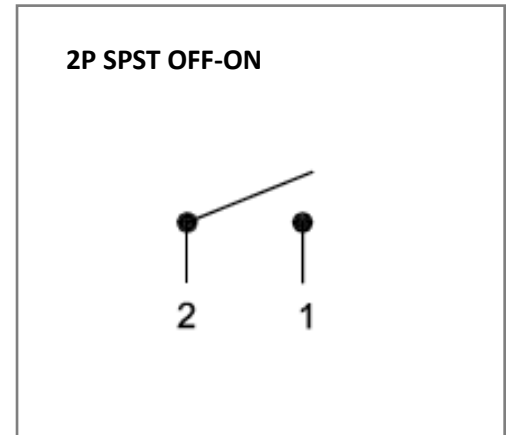

Electrical Specifications

Rating	21A 14V DC, 10A 28V DC
Contact Resistance	50m ohm Max
Insulation Resistance	DC 500V 100M ohm Min
Dielectric Strength	AC 1500V 1minute
Operation Temperature	-25°C~85°C

Material Specifications

Frame	Black, Nylon #66
Actuator	Black, Nylon 66+33%GF
Waterproof	IP56

Rev	Date of issue	Revision Notes	Designed	Approved
B	02-26-2020	Initial Drawing	RC	OF