



IP65 IP67 (FC) c  us EAC FC

### ■ Features

- Wide input range 180 ~ 528VAC
- Constant Voltage + Constant Current mode output
- Metal housing with Class I design
- Built-in active PFC function
- IP67 / IP65 rating for indoor or outdoor installations
- Function options: output adjustable via potentiometer; 3 in 1 dimming (dim-to-off) ; Smart timer dimming
- Typical lifetime > 50000 hours
- 5 years warranty

### ■ Applications

- LED greenhouse lighting
- LED stadium lighting
- LED mining lighting
- Type "HL" for use in Class I, Division 2 hazardous (Classified) location

### ■ Description

HVG-480 series is a 480W AC/DC LED driver featuring the dual mode constant voltage and constant current output. HVG-480 operates from 180~528VAC and offers models with different rated voltage ranging between 24V and 54V. Thanks to the high efficiency up to 95%, with the fanless design, the entire series is able to operate for -40°C~+85°C case temperature under free air convection. The design of metal housing and IP67/IP65 ingress protection level allows this series to fit both indoor and outdoor applications. HVG-480 is equipped with various function options, such as dimming methodologies, so as to provide the optimal design flexibility for LED lighting system.

### ■ Model Encoding

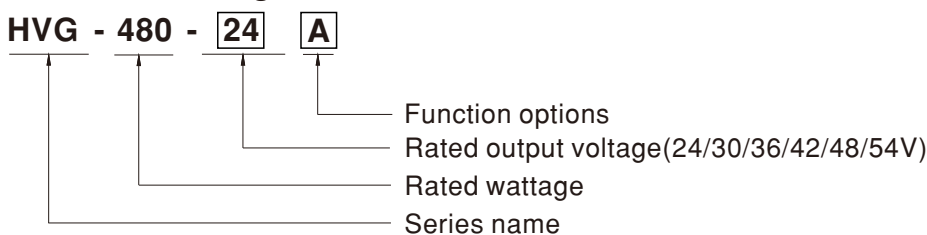

Type	IP Level	Function	Note
A	IP65	Io and Vo adjustable through built-in potentiometer.	In Stock
B	IP67	3 in 1 dimming function (0~10Vdc, 10V PWM signal and resistance)	In Stock
AB	IP65	Io and Vo adjustable through built-in potentiometer & 3 in 1 dimming function (0~10Vdc, 10V PWM signal and resistance)	In Stock
Dx	IP67	Built-in Smart timer dimming function by user request.	By request
D2	IP67	Built-in Smart timer dimming and programmable function.	In Stock



# 480W Constant Voltage + Constant Current LED Driver **HVG-480** series

## SPECIFICATION

MODEL	HVG-480-24□	HVG-480-30□	HVG-480-36□	HVG-480-42□	HVG-480-48□	HVG-480-54□	
OUTPUT	DC VOLTAGE	24V	30V	36V	42V	48V	54V
	CONSTANT CURRENT REGION <small>Note.4</small>	12 ~ 24V	15 ~ 30V	18 ~ 36V	21 ~ 42V	24 ~ 48V	27 ~ 54V
	RATED CURRENT	20A	16A	13.3A	11.4A	10A	8.9A
	RATED POWER	480W	480W	478.8W	478.8W	480W	480.6W
	RIPPLE & NOISE (max.) <small>Note.2</small>	200mVp-p	200mVp-p	250mVp-p	250mVp-p	250mVp-p	350mVp-p
	VOLTAGE ADJ. RANGE	Adjustable for A/AB-Type only (via built-in potentiometer)					
		20.4 ~ 25.2V	25.5 ~ 31.5V	30.6 ~ 37.8V	35.7 ~ 44.1V	40.8 ~ 50.4V	45.9 ~ 56.7V
	CURRENT ADJ. RANGE	Adjustable for A/AB-Type only (via built-in potentiometer)					
		10 ~ 20A	8 ~ 16A	6.6 ~ 13.3A	5.7 ~ 11.4A	5 ~ 10A	4.4 ~ 8.9A
	VOLTAGE TOLERANCE <small>Note.3</small>	±1.0%	±1.0%	±1.0%	±1.0%	±1.0%	±1.0%
	LINE REGULATION	±0.5%	±0.5%	±0.5%	±0.5%	±0.5%	±0.5%
LOAD REGULATION	±0.5%	±0.5%	±0.5%	±0.5%	±0.5%	±0.5%	
SETUP, RISE TIME <small>Note.6</small>	500ms, 100ms / 230VAC, 347VAC, 480VAC						
HOLD UP TIME (Typ.)	16ms / 347VAC, 480VAC						
INPUT	VOLTAGE RANGE <small>Note.5</small>	180 ~ 528VAC 254VDC ~ 747VDC (Please refer to "STATIC CHARACTERISTIC" section)					
	FREQUENCY RANGE	47 ~ 63Hz					
	POWER FACTOR (Typ.)	PF ≥ 0.98/230VAC, PF ≥ 0.98/277VAC, PF ≥ 0.97/347VAC, PF ≥ 0.95/480VAC @ full load (Please refer to "POWER FACTOR (PF) CHARACTERISTIC" section)					
	TOTAL HARMONIC DISTORTION	THD < 20% (@ load ≥ 50% at 230VAC/277VAC/347VAC/480VAC input Please refer to "TOTAL HARMONIC DISTORTION (THD)" section					
	EFFICIENCY (Typ.)	94%	94%	94.5%	95%	95%	95%
	AC CURRENT (Typ.)	1.52A / 347VAC		1.15A / 480VAC			
	INRUSH CURRENT(Typ.)	COLD START 40A(t <sub>width</sub> =1100μs measured at 50% I <sub>peak</sub> ) at 480VAC ; Per NEMA 410					
	MAX. NO. of PSUs on 16A CIRCUIT BREAKER	4unit(circuit breaker of type B) / 6units(circuit breaker of type C) at 480VAC					
LEAKAGE CURRENT	<0.75mA / 480VAC						
PROTECTION	OVER CURRENT	95 ~ 108% Constant current limiting, recovers automatically after fault condition is removed					
	SHORT CIRCUIT	Constant current limiting, recovers automatically after fault condition is removed					
	OVER VOLTAGE	26 ~ 30V	32.5 ~ 36.5V	39.5 ~ 45V	46 ~ 50V	51.5 ~ 58V	58 ~ 65V
	OVER TEMPERATURE	Shut down output voltage, re-power on to recovery					
ENVIRONMENT	WORKING TEMP.	T <sub>case</sub> =-40 ~ +85°C (Please refer to "OUTPUT LOAD vs TEMPERATURE" section)					
	MAX. CASE TEMP.	T <sub>case</sub> =+85°C					
	WORKING HUMIDITY	20 ~ 95% RH non-condensing					
	STORAGE TEMP., HUMIDITY	-40 ~ +80°C, 10 ~ 95% RH non-condensing					
	TEMP. COEFFICIENT	±0.03%/°C (0 ~ 60°C)					
SAFETY & EMC	VIBRATION	10 ~ 500Hz, 5G 12min./1cycle, period for 72min. each along X, Y, Z axes					
	SAFETY STANDARDS	UL8750 (type"HL"), CSA C22.2 No. 250.13-12, IP65 or IP67, EAC TP TC 004 approved					
	WITHSTAND VOLTAGE	I/P-O/P:3.75KVAC I/P-FG:2KVAC O/P-FG:1.5KVAC					
	ISOLATION RESISTANCE	I/P-O/P, I/P-FG, O/P-FG:100M Ohms / 500VDC / 25°C / 70% RH					
	EMC EMISSION	Compliance to FCC Part 15 Subpart B, EAC TP TC 020					
OTHERS	EMC IMMUNITY	Immunity Line-Earth 4KV, Line-Line 2KV, EAC TP TC 020					
	MTBF	318.9K hrs min. Telcordia SR-332(Bellcore) ; 84.5K hrs min. MIL-HDBK-217F (25°C)					
	DIMENSION	262*125*43.8mm (L*W*H)					
	PACKING	2.8Kg;4pcs/12.2Kg/0.55CUFT					
NOTE	<p>1. All parameters NOT specially mentioned are measured at 347VAC input, rated load and 25°C of ambient temperature.</p> <p>2. Ripple &amp; noise are measured at 20MHz of bandwidth by using a 12" twisted pair-wire terminated with a 0.1uf &amp; 47uf parallel capacitor.</p> <p>3. Tolerance : includes set up tolerance, line regulation and load regulation.</p> <p>4. Please refer to "DRIVING METHODS OF LED MODULE".</p> <p>5. De-rating may be needed under low input voltages. Please refer to "STATIC CHARACTERISTIC" sections for details.</p> <p>6. Length of set up time is measured at first cold start. Turning ON/OFF the power supply may lead to increase of the set up time.</p> <p>7. The driver is considered as a component that will be operated in combination with final equipment. Since EMC performance will be affected by the complete installation, the final equipment manufacturers must re-qualify EMC Directive on the complete installation again.</p> <p>8. This series meets the typical life expectancy of &gt;50,000 hours of operation when T<sub>case</sub>, particularly (T<sub>c</sub>) point (or T<sub>MP</sub>, per DLC), is about 80°C or less.</p> <p>9. Please refer to the warranty statement on MEAN WELL's website at <a href="http://www.meanwell.com">http://www.meanwell.com</a></p> <p>10. The ambient temperature derating of 3.5°C/1000m with fanless models and of 5°C/1000m with fan models for operating altitude higher than 2000m(6500ft).</p> <p>11. For any application note and IP water proof function installation caution, please refer our user manual before using. <a href="https://www.meanwell.com/Upload/PDF/LED_EN.pdf">https://www.meanwell.com/Upload/PDF/LED_EN.pdf</a></p> <p>※ Product Liability Disclaimer : For detailed information, please refer to <a href="https://www.meanwell.com/serviceDisclaimer.aspx">https://www.meanwell.com/serviceDisclaimer.aspx</a></p>						

## ■ BLOCK DIAGRAM

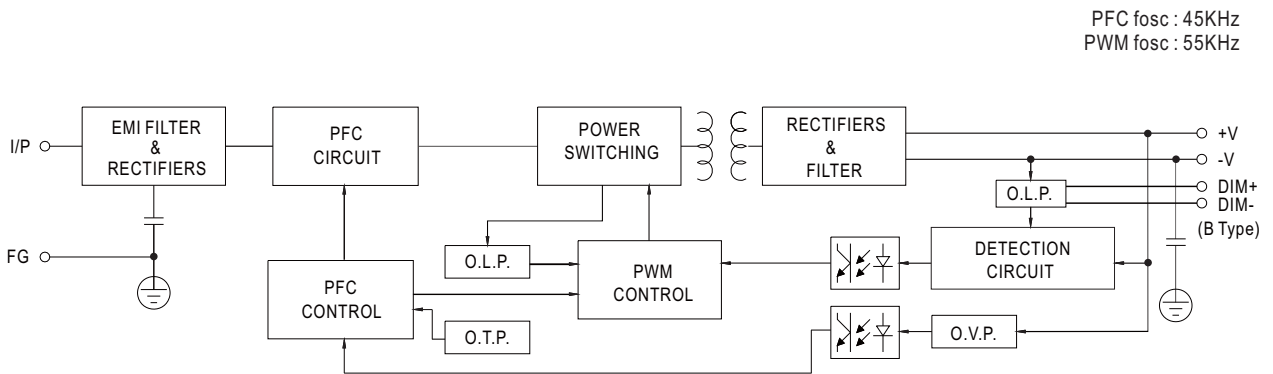

## ■ DRIVING METHODS OF LED MODULE

※ This series is able to work in either Constant Current mode (a direct drive way) or Constant Voltage mode (usually through additional DC/DC driver) to drive the LEDs.

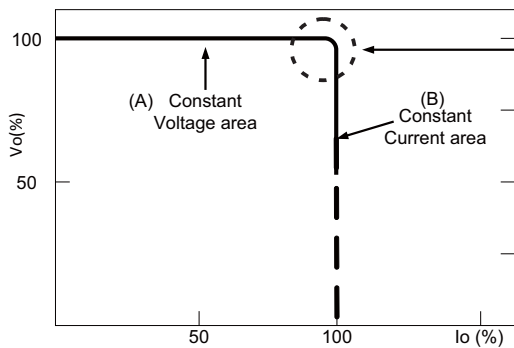

Typical LED power supply I-V curve

In the constant current region, the highest voltage at the output of the driver depends on the configuration of the end systems.

Should there be any compatibility issues, please contact MEAN WELL.

## ■ DIMMING OPERATION

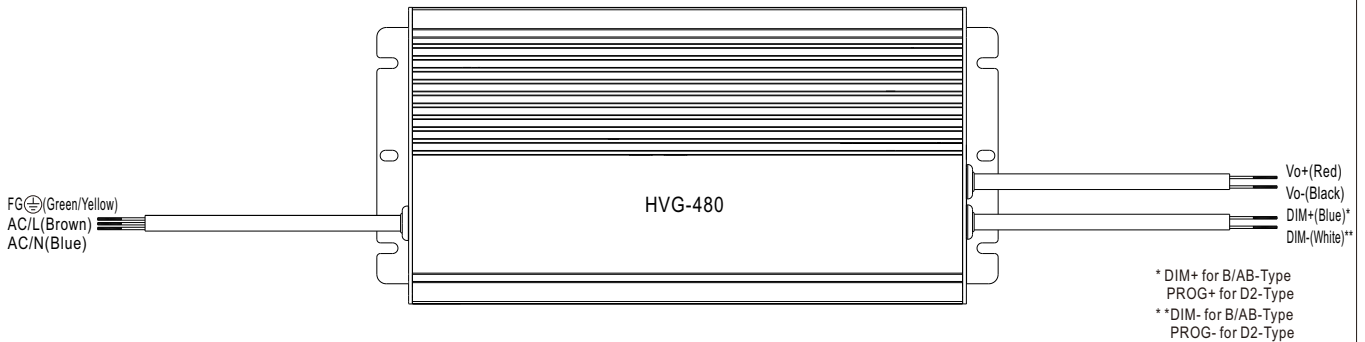

### ※ 3 in 1 dimming function (for B/AB-Type)

- Output constant current level can be adjusted by applying one of the three methodologies between DIM+ and DIM-:  
0 ~ 10VDC, or 10V PWM signal or resistance.
- Direct connecting to LEDs is suggested. It is not suitable to be used with additional drivers.
- Dimming source current from power supply: 100 $\mu$ A (typ.)

#### ◎ Applying additive 0 ~ 10VDC

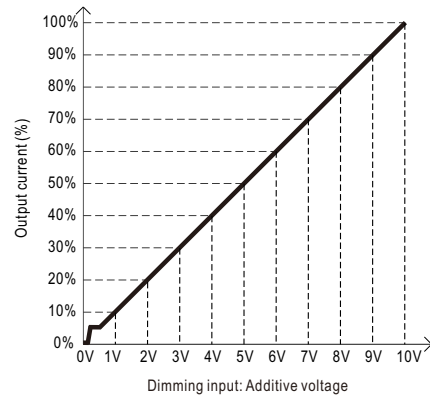
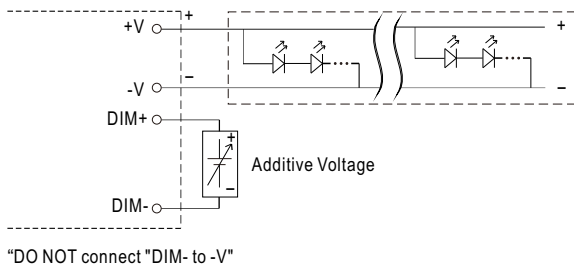

#### ◎ Applying additive 10V PWM signal (frequency range 100Hz ~ 3KHz):

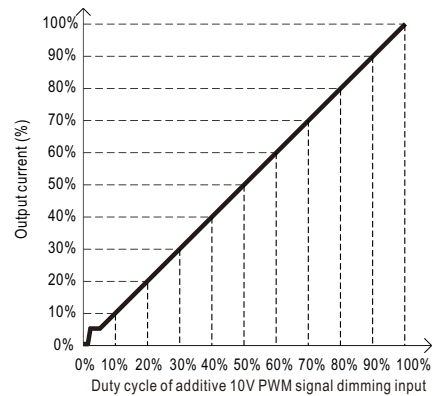
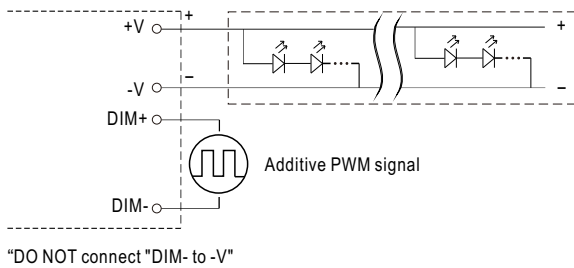

#### ◎ Applying additive resistance:

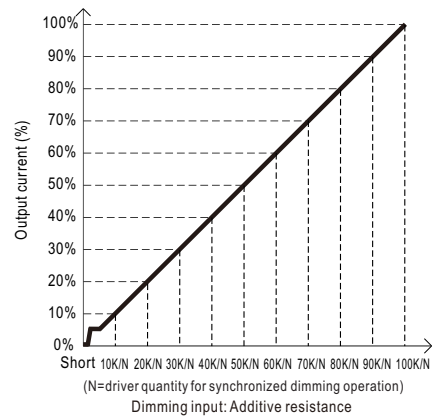
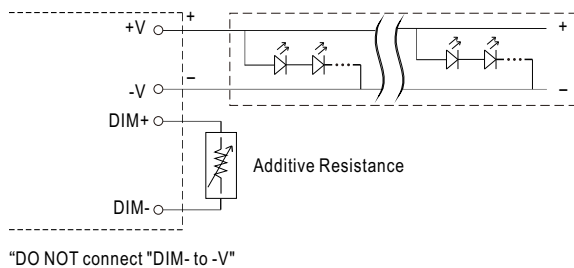

Note : 1. Min. dimming level is about 5% and the output current is not defined when  $0\% < I_{out} < 5\%$ .

2. The output current could drop down to 0% when dimming input is about  $0k\Omega$  or 0Vdc, or 10V PWM signal with 0% duty cycle.

※ **Smart timer dimming function (for Dxx-Type by User definition)**

MEAN WELL Smart timer dimming primarily provides the adaptive proportion dimming profile for the output constant current level to perform up to 14 consecutive hours. 3 dimming profiles hereunder are defined accounting for the most frequently seen applications. If other options may be needed, please contact MEAN WELL for details.

Ex : ☉ D01-Type: the profile recommended for residential lighting

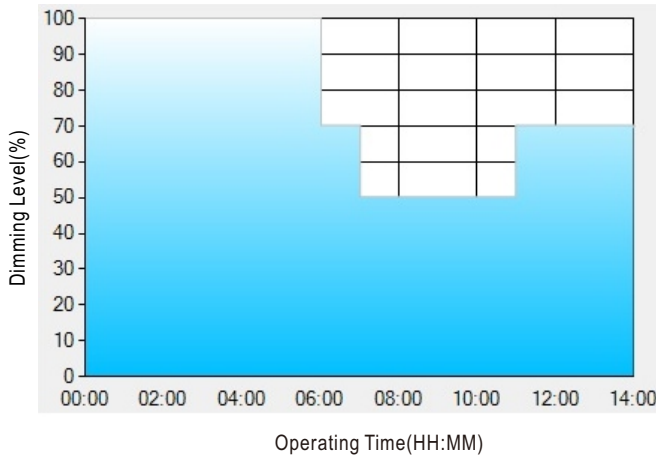

Set up for D01-Type in Smart timer dimming software program:

	T1	T2	T3	T4
TIME**	06:00	07:00	11:00	---
LEVEL**	100%	70%	50%	70%

\*\* : TIME matches Operating Time in the diagram whereas LEVEL matches Dimming Level.

Example: If a residential lighting application adopts D01-Type, when turning on the power supply at 6:00pm, for instance:

- [1] The power supply will switch to the constant current level at 100% starting from 6:00pm.
  - [2] The power supply will switch to the constant current level at 70% in turn, starting from 0:00am, which is 06:00 after the power supply turns on.
  - [3] The power supply will switch to the constant current level at 50% in turn, starting from 1:00am, which is 07:00 after the power supply turns on.
  - [4] The power supply will switch to the constant current level at 70% in turn, starting from 5:00am, which is 11:00 after the power supply turns on.
- The constant current level remains till 8:00am, which is 14:00 after the power supply turns on.

Ex : ☉ D02-Type: the profile recommended for street lighting

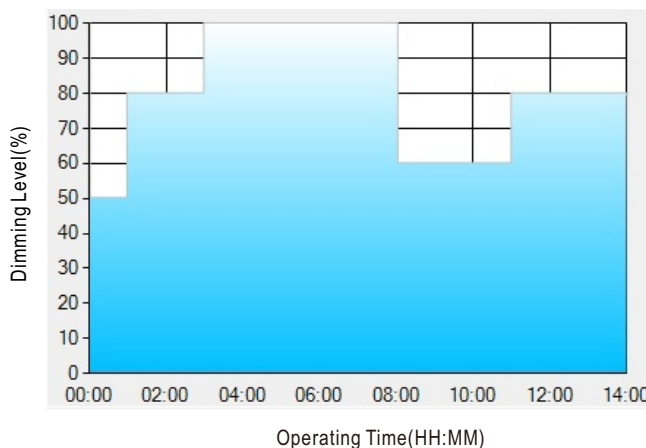

Set up for D02-Type in Smart timer dimming software program:

	T1	T2	T3	T4	T5
TIME**	01:00	03:00	8:00	11:00	---
LEVEL**	50%	80%	100%	60%	80%

\*\* : TIME matches Operating Time in the diagram whereas LEVEL matches Dimming Level.

Example: If a street lighting application adopts D02-Type, when turning on the power supply at 5:00pm, for instance:

- [1] The power supply will switch to the constant current level at 50% starting from 5:00pm.
- [2] The power supply will switch to the constant current level at 80% in turn, starting from 6:00pm, which is 01:00 after the power supply turns on.
- [3] The power supply will switch to the constant current level at 100% in turn, starting from 8:00pm, which is 03:00 after the power supply turns on.
- [4] The power supply will switch to the constant current level at 60% in turn, starting from 1:00am, which is 08:00 after the power supply turns on.
- [5] The power supply will switch to the constant current level at 80% in turn, starting from 4:00am, which is 11:00 after the power supply turns on. The constant current level remains till 6:30am, which is 14:00 after the power supply turns on.

Ex: © D03-Type: the profile recommended for tunnel lighting

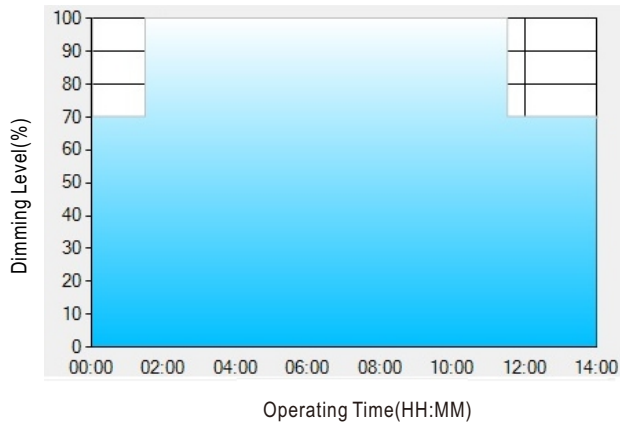

Set up for D03-Type in Smart timer dimming software program:

	T1	T2	T3
TIME**	01:30	11:00	---
LEVEL**	70%	100%	70%

\*\* : TIME matches Operating Time in the diagram whereas LEVEL matches Dimming Level.

Example: If a tunnel lighting application adopts D03-Type, when turning on the power supply at 4:30pm, for instance:

[1] The power supply will switch to the constant current level at 70% starting from 4:30pm.

[2] The power supply will switch to the constant current level at 100% in turn, starting from 6:00pm, which is 01:30 after the power supply turns on.

[3] The power supply will switch to the constant current level at 70% in turn, starting from 5:00am, which is 11:00 after the power supply turns on.

The constant current level remains till 6:30am, which is 14:00 after the power supply turns on.

### OUTPUT LOAD vs TEMPERATURE(Notes.9)

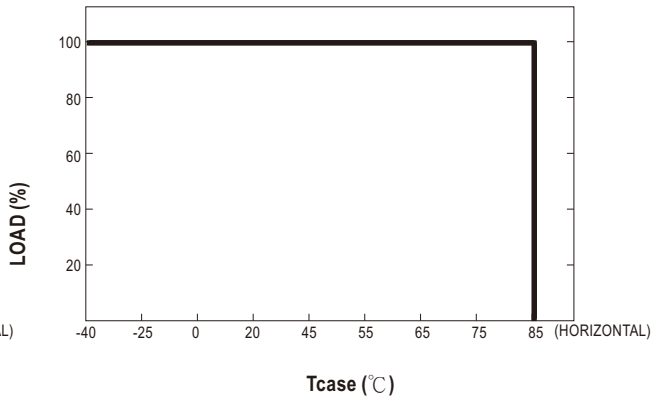
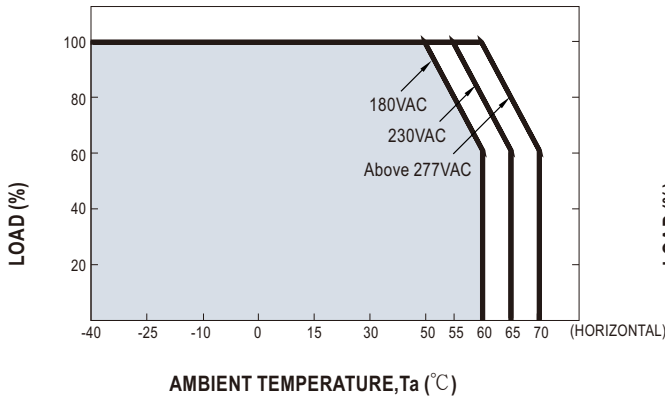

If HVG-480 operates in Constant Current mode with the rated current, the maximum workable Ta is 55°C (Typ. 230VAC)

### STATIC CHARACTERISTIC

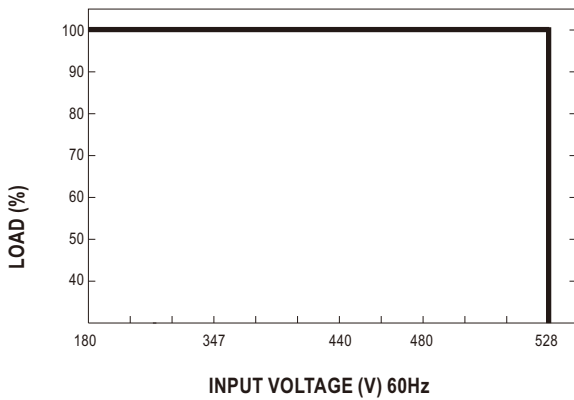

### POWER FACTOR (PF) CHARACTERISTIC

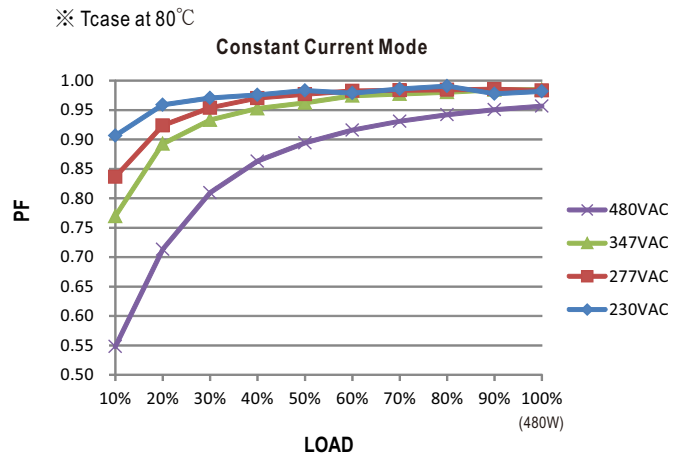

### TOTAL HARMONIC DISTORTION (THD)

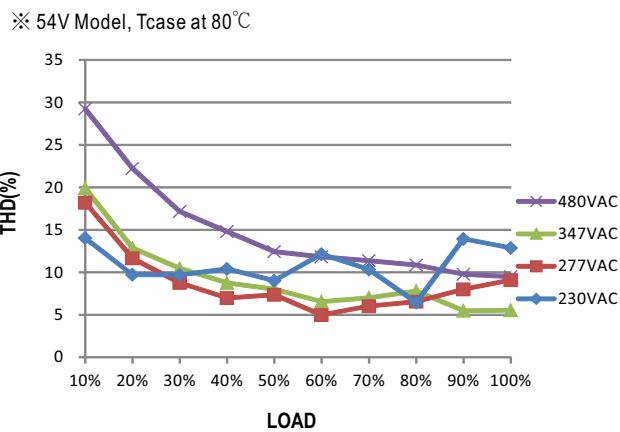

### EFFICIENCY vs LOAD

HVGC-480 series possess superior working efficiency that up to 95% can be reached in field applications.

※ 54V Model, Tcase at 80°C

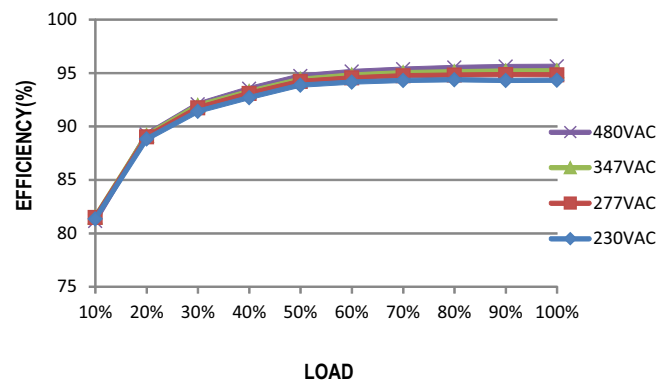



■ LIFE TIME

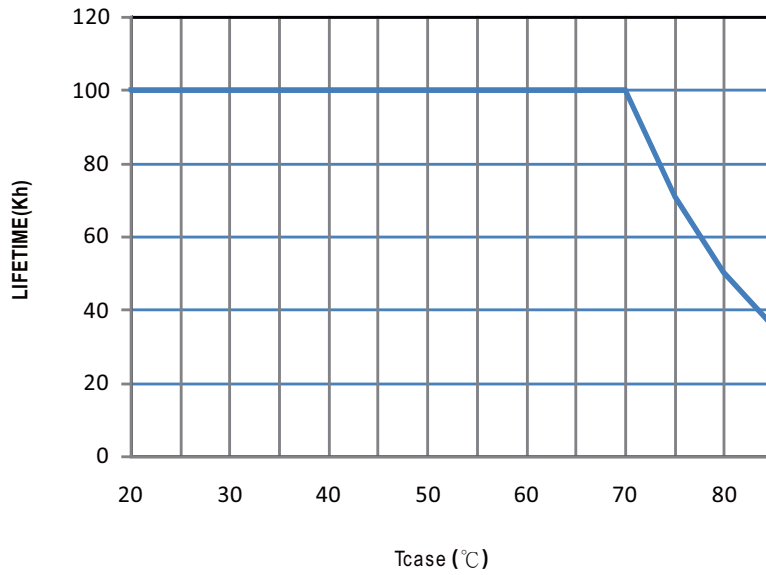



**MECHANICAL SPECIFICATION**

Case No. 251 Unit:mm

※ A-Type

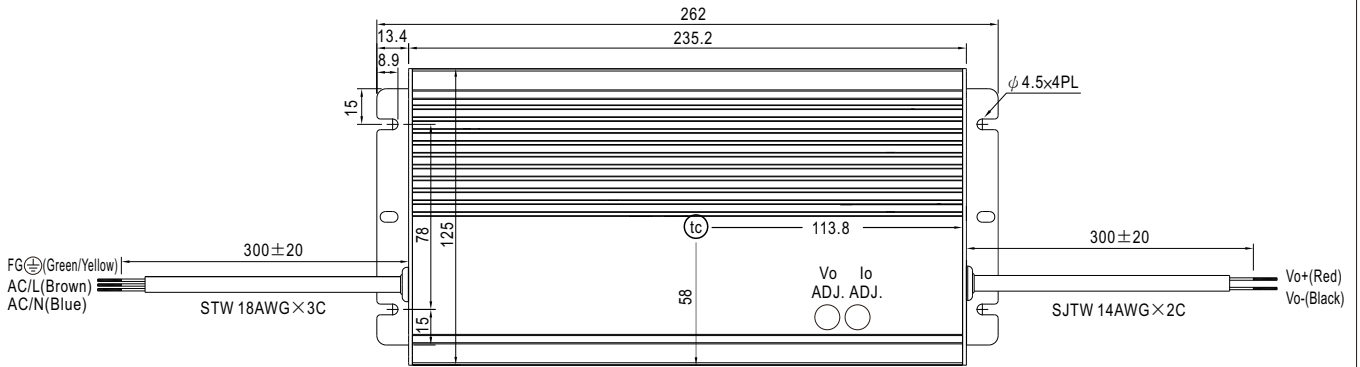

•  $t_c$  : Max. Case Temperature

※ AB-Type

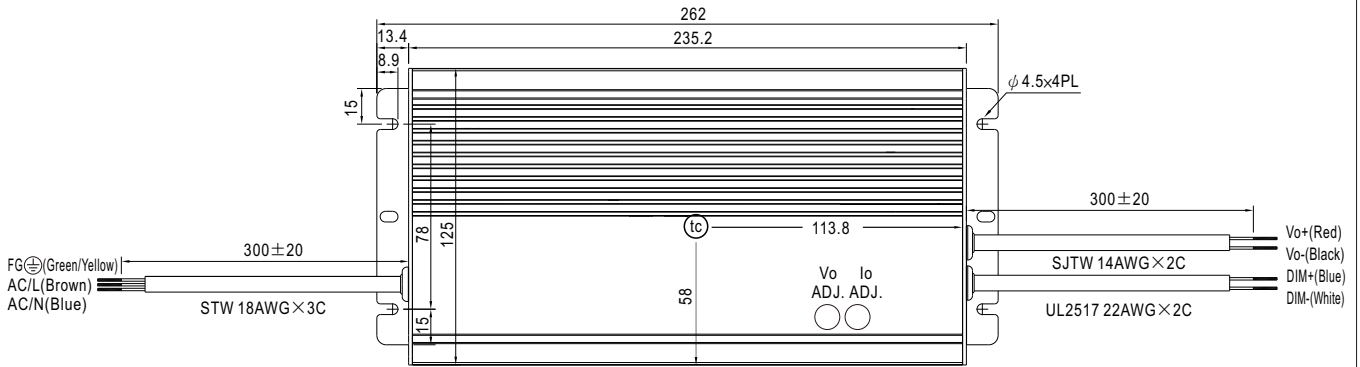

•  $t_c$  : Max. Case Temperature



※B/D2-Type

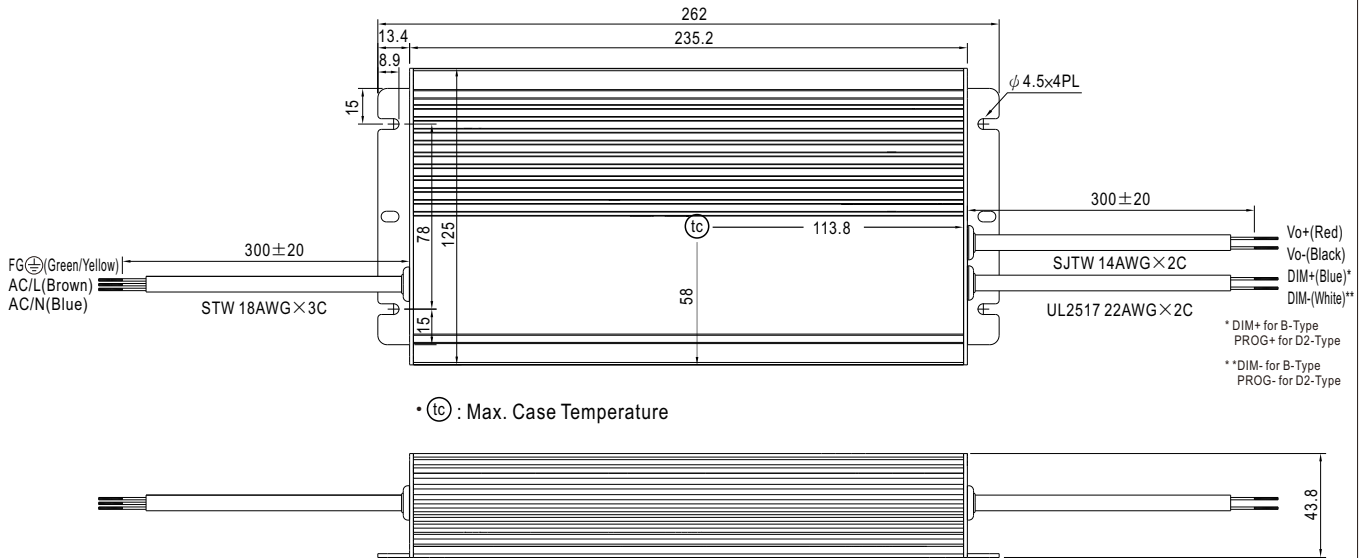

## ■ INSTALLATION MANUAL

Please refer to : <http://www.meanwell.com/manual.html>