

CGA4J2C0G2A272J125AA

TDK Item Description : CGA4J2C0G2A272JT***



Equivalent C2012C0G2A272J for Automotive

Application & Main Feature

Automotive Grade (Mid Voltage (100 to 630V))

Series

CGA4(2012) [EIA CC0805]

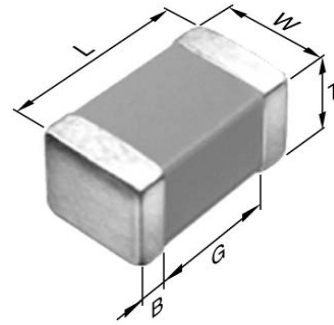

Dimensions

- L 2.00mm +/-0.2mm
- W 1.25mm +/-0.2mm
- T 1.25mm +/-0.2mm
- B 0.20mm Min.
- G 0.50mm Min.

Temperature Characteristic

C0G (-55 to 125 degC 0+/-30ppm/degC)

Rated Voltage

2A (100Vdc)

Capacitance

2.7nF

Capacitance Tolerance

J (+/-5%)

Q Factor

1000 Min.

Insulation Resistance

10Gohm Min.

AEC-Q200

Yes

|Z|, ESR vs. Freq. Characteristics

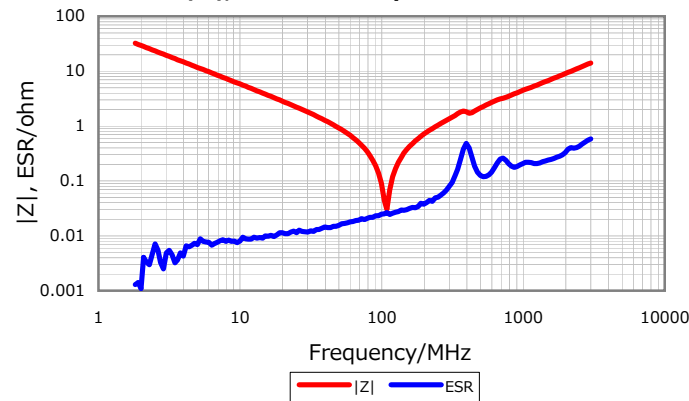

DC Bias Characteristic

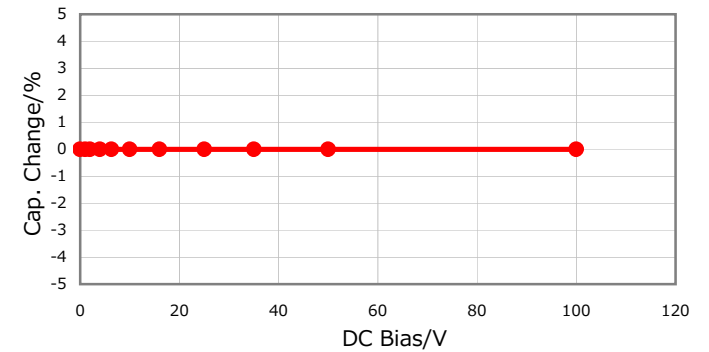

Cap. vs. Freq. Characteristic

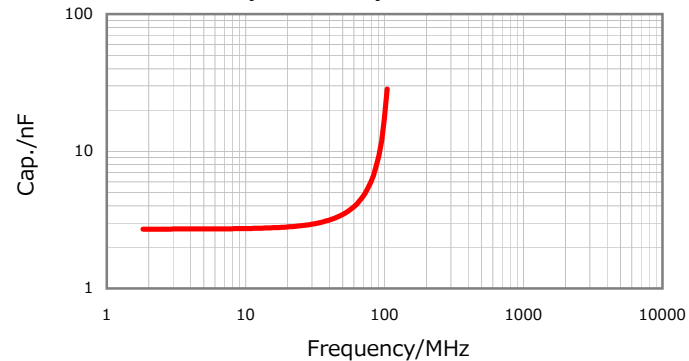

Temperature Characteristics

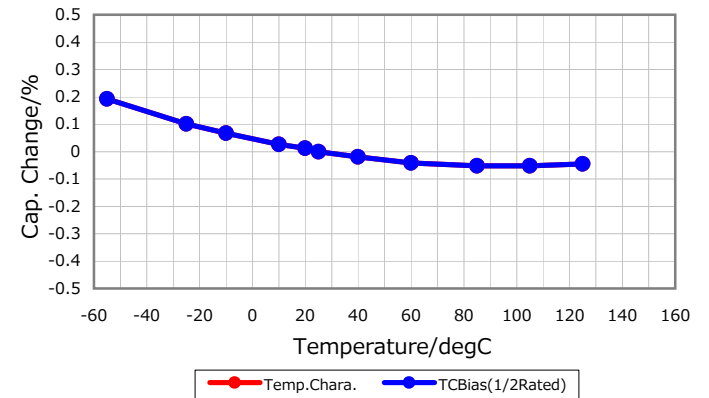

Characterization Sheet (Multilayer Ceramic Chip Capacitors)



All specifications are subject to change without notice.

January 4, 2016