

IGT203

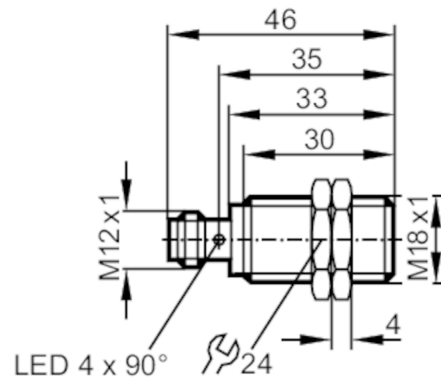

Inductive sensor

IGB3008BBPKG/M/V4A/US-104-DPS



Product characteristics

Electrical design		PNP
Output function		normally open
Sensing range	[mm]	8
Housing		threaded type
Dimensions	[mm]	M18 x 1 / L = 46

Application

Special feature		Gold-plated contacts; Increased sensing range
Application		regular cleaning processes

Electrical data

Operating voltage	[V]	10...36 DC
Current consumption	[mA]	10; (24 V)
Protection class		II
Reverse polarity protection		yes

Outputs

Electrical design		PNP
Output function		normally open
Max. voltage drop switching output DC	[V]	2.5
Permanent current rating of switching output DC	[mA]	100
Switching frequency DC	[Hz]	600
Short-circuit protection		yes
Type of short-circuit protection		pulsed
Overload protection		yes

Detection zone

Sensing range	[mm]	8
Operating distance	[mm]	0...6.48
Increased sensing range		yes

IGT203



Inductive sensor

IGB3008BBPKG/M/V4A/US-104-DPS

Accuracy / deviations		
Correction factor	steel: 1 / stainless steel: 0.7 / brass: 0.4 / aluminium: 0.4 / copper: 0.3	
Hysteresis	[% of Sr]	1...20
Operating conditions		
Ambient temperature	[°C]	0...100
Protection	IP 68; IP 69K; ("COP")	
Tests / approvals		
EMC	EN 61000-4-2 ESD	4 kV CD / 8 kV AD
	EN 61000-4-3 HF radiated	10 V/m
	EN 61000-4-4 Burst	2 kV
	EN 61000-4-6 HF conducted	10 V
	EN 55011	class B
MTTF	[years]	1727
UL approval	Ta	0...40 °C
	Enclosure type	Type 1
	voltage supply	Limited Voltage/Current
	File number UL	E174191
Mechanical data		
Weight	[g]	44.7
Housing	threaded type	
Mounting	flush mountable	
Dimensions	[mm]	M18 x 1 / L = 46
Thread designation	M18 x 1	
Materials	threaded sleeve: stainless steel (1.4404 / 316L); sensing face: PEEK; lock nuts: stainless steel	
Displays / operating elements		
Display	switching status	4 x 90° LED, yellow
Accessories		
Items supplied	lock nuts: 2	
Remarks		
Pack quantity	1 pcs.	
Electrical connection - plug		
Connector: 1 x M12; Contacts: gold-plated		



IGT203



Inductive sensor

IGB3008BBPKG/M/V4A/US-104-DPS

Connection

