

Evaluation Board for the **AD7134** 24-Bit, 4-Channel, Simultaneous Sampling, 1.5 MSPS Precision Alias Free ADC

FEATURES

Fully featured evaluation board for the **AD7134**
PC control in conjunction with the **SDP-H1** board
PC software control and data analysis
Standalone hardware capability
Two **AD7134** ADCs to demonstrate multidevice simultaneous sampling

EVALUATION KIT CONTENTS

EVAL-AD7134FMCZ board
AD7134

DOCUMENTS NEEDED

AD7134 data sheet

EQUIPMENT NEEDED

Evaluation kit
SDP-H1 board
DC or ac signal source (audio precision or a similar high performance signal source)
PC running Windows® with a USB 2.0 port and the evaluation tool installed

SOFTWARE NEEDED

AD7134 evaluation software

GENERAL DESCRIPTION

The EVAL-AD7134FMCZ evaluation kit features the **AD7134** 24-bit, 4-channel, simultaneous sampling, 1.5 MSPS precision alias free analog-to-digital converter (ADC). Two on-board **AD7134** ADCs are included to demonstrate multidevice simultaneous sampling. The EVAL-AD7134FMCZ draws power from the system demonstration platform (SDP) **EVAL-SDP-CH1Z** (**SDP-H1**) board, and the on-board dc-to-dc regulators regulate an external supply of 8 V to 14 V down to 5 V, 1.8 V, and 1.2 V to supply the **AD7134** and peripheral components. Both on-board ADCs have a separate reference of 4.096 V generated by the on-board **ADR444**. The ADCs have three clock input options and can be clocked by a crystal input, a microelectromechanical system (MEMS) oscillator, or a complementary metal-oxide semiconductor (CMOS) clock.

The EVAL-AD7134FMCZ connects to the PC USB port via the **SDP-H1** board.

The **AD7134** evaluation software running on a PC provides full accessibility to the **AD7134** device register map, as well as a data analysis interface to display key parameters and graphics from the conversion result in both time and frequency domains.

For full details on the **AD7134**, see the **AD7134** data sheet, which must be consulted in conjunction with this user guide when using the EVAL-AD7134FMCZ.

EVAL-AD7134FMCZ PHOTOGRAPH

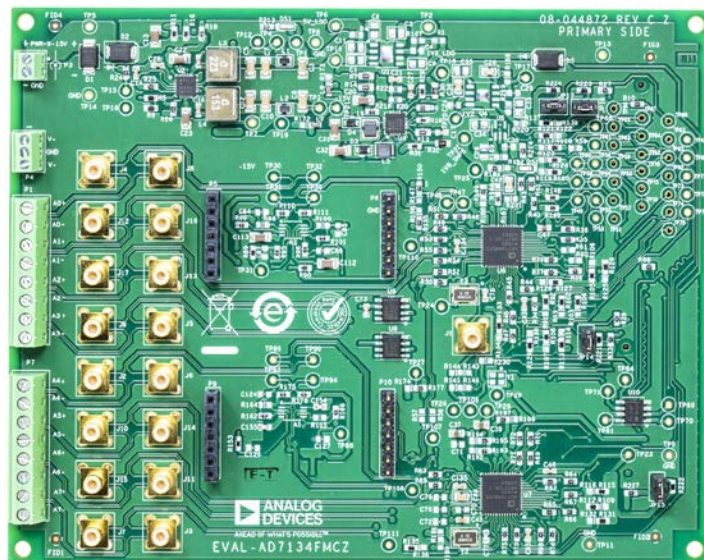

Figure 1.

TABLE OF CONTENTS

Features	1	Serial Data Interface.....	7
Evaluation Kit Contents.....	1	8-Channel Data.....	7
Documents Needed.....	1	Daisy-Chaining and Minimal Input/Output Configuration...	7
Equipment Needed.....	1	Configuration Control Modes.....	8
Software Needed.....	1	Pin Control Mode	8
General Description.....	1	SPI Control Mode	8
EVAL-AD7134FMCZ Photograph.....	1	Evaluation Board Software Quick Start Procedures.....	10
Revision History	2	Software Installation	10
Evaluation Board Quick Start Procedure.....	3	Using the Software for Testing.....	11
Known Limitations and Issues.....	3	Evaluation Board Schematics and Artwork.....	13
Evaluation Board Hardware.....	4	Ordering Information.....	20
Analog Inputs and Front-End Circuit	4	Bill of Materials.....	20
Power Supply Options	5		
Connectors and Sockets	6		

REVISION HISTORY

4/2020—Revision 0: Initial Version

EVALUATION BOARD QUICK START PROCEDURE

The EVAL-AD7134FMCZ default configuration can be modified according to the evaluation requirement.

The [AD7134](#) evaluation software must be installed before setting up the EVAL-AD7134FMCZ. See the Software Installation section for more details.

To set up the EVAL-AD7134FMCZ, take the following steps:

1. Ensure that the [SDP-H1](#) board is powered off and disconnected from the USB port of the PC, and then download and install the [AD7134](#) evaluation software.
2. When the [AD7134](#) evaluation software installation is complete, restart the PC. See the Software Installation section for more details on the [AD7134](#) evaluation software installation.
3. Connect the J4 connector of the [SDP-H1](#) board to the P8 connector of the powered down EVAL-AD7134FMCZ, as shown in Figure 2. Ensure that the boards are connected firmly together.
4. Connect the 12 V dc adaptor to the [SDP-H1](#) board. The EVAL-AD7134FMCZ draws power from the [SDP-H1](#) board and does not require any separate power connection.
5. Connect the [SDP-H1](#) board to the PC using the USB cable provided with the [SDP-H1](#) board. The PC can search for the [SDP-H1](#) board drivers automatically. If prompted by

the operating system, choose to automatically search for the drivers for the [SDP-H1](#) board.

6. Launch the [AD7134](#) evaluation software from the shortcut on the desktop, as shown in Figure 13.

KNOWN LIMITATIONS AND ISSUES

The known limitations and issues for the EVAL-AD7134FMCZ include the following:

- GPIO functionality cannot be exercised in SPI mode. The DCLKRATE1/GPIO1, DCLKRATE2/GPIO2, PWRMODE/GPIO3, FILTER0/GPIO4, FILTER1/GPIO5, FRAME0/GPIO6, and FRAME1/GPIO7 pins are only used for pin control mode configuration usage.
- The [AD7134](#) evaluation software does not support free running DCLK mode, minimal input/output mode, daisy-chaining mode, 16-bit data mode, 16-bit data with CRC, or 24-bit data with CRC.
- Evaluation software only supports a fixed DCLK frequency value of 48 MHz.
- CLKSEL_1 and CLKSEL_2 in Figure 19 connect to 1V8CLKVDD using R133 and R135. It is recommended to wire CLKSEL_1 and CLKSEL_2 to IOVDD instead of 1V8CLKVDD.



Figure 2. EVAL-AD7134FMCZ and [SDP-H1](#) Board Connection

20095-003

EVALUATION BOARD HARDWARE

ANALOG INPUTS AND FRONT-END CIRCUIT

The EVAL-AD7134FMCZ features two AD7134 devices that have a total of eight ADC channels operating in parallel to each other. A differential input signal feeds to the front-end circuit via either the Subminiature Version B (SMB) connectors or the terminal blocks. The input signal for Channel 0 and Channel 4 can be fed either directly via the front end, or via an amplifier mezzanine card (AMC) by using the solder link options shown in Table 1 and Table 2. The signal is fed directly for all other channels.

Table 1. Input Connection Options for Channel 0

Input	Mounted	Not Mounted	Comments
Direct	R150, R155	R147, R156	Default
Front End	R147, R156	R150, R155	Mount R86, R87
AMC		R150, R147, R155, R156	Open R86 and R87

Table 2. Input Connection Options for Channel 4

Input	Mounted	Not Mounted	Comments
Direct	R158, R170	R157, R171	Default
Front End	R157, R171	R158, R170	Mount R152 and R151
AMC		R157, R158, R170, R171	Open R152 and R151

The amplifier inputs do not terminate for any particular source impedances. The on-board, common-mode voltage (V_{CM}) source on the AD7134 biases the input signal. The default condition is $V_{CM} = V_{REF}/2$, where V_{REF} is the reference voltage.

Another option available for the front-end circuit is using an AMC, which is available for Channel 0 and Channel 4. An AMC uses the P5 and P6 connectors for Channel 0, and the P9 and P10 connectors for Channel 4 to connect to the EVAL-AD7134FMCZ.

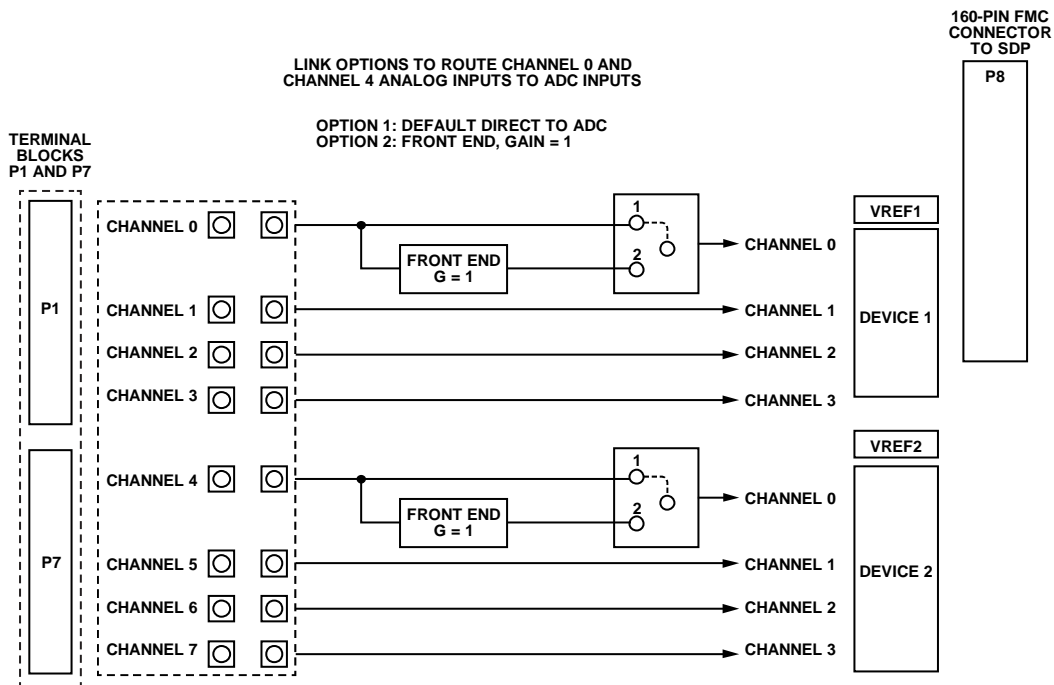

Figure 3. Analog Front-End Block

POWER SUPPLY OPTIONS

Device Power Supply

The AD7134 can be powered with external supplies, or the integrated low dropout (LDO) regulators can generate the 1.8 V rails to supply the AVDD1V8, DVDD1V8, and CLKVDD supplies.

See Table 3 for setting the desired power rail option. The suffix *_1* in the name of the power rail is for Device 1 and the suffix *_2* is for Device 2. The IOVDD pin supplies the interface logic and is powered up by the SDP-H1 board via the field-programmable gate array (FPGA) mezzanine card (FMC) connector.

Front-End Circuit Power Supply

Options available to power the analog front-end circuit include the following:

- 5 V supply
- ±15 V supply
- P4 external connector

Table 3. Power Rail Options

Power Rail	Link	Internal LDO Regulator	External Supply (Default)
1V8CLKVDD	R226, R227	Not connected	Mounted
1V8DVDD_1	R183	Not connected	Mounted
1V8AVDD_1	R191	Not connected	Mounted
LDOIN_1	R187	Not connected	Mounted
1V8DVDD_2	R199	Not connected	Mounted
1V8AVDD_2	R197	Not connected	Mounted
LDOIN_2	R201	Not connected	Mounted

Table 4. Front-End Circuit Power Options

Power Rail	Source (V)	Mounted	Not Mounted	Default
+PWRAFE	5	R172	L7	No
	15	L7	R172	Yes
-PWRAFE	0	R173	L8	No
	-15	L8	R173	Yes

Table 5. Clock Options

Clock Connection	Mounted	Not Mounted	Comments
Individual Crystals	Not applicable	R143, R144, R145, R146	Default
MEMS Clock	R144, R145	R143, R146	Remove Y2, Y3, C77, and C78; mount Y1
SDP CLK	R144, R145	R143, R146	Remove Y2, Y3, C77, and C78; close R230
XCLKOUT Pin of Device 1 to XTAL2/CLKIN Pin of Device 2	R144, R146	R143, R145	Remove Y2, Y3, C77, and C78
XCLKOUT Pin of Device 2 to XTAL2/CLKIN Pin of Device 1	R143, R145	R144, R146	Remove Y2, Y3, C77, and C78

Table 6. LED Functions

LED	Description
DS1	Power indication LED. When this LED is illuminated, it indicates that power is present on the EVAL-AD7134FMCZ.
DS2	Power indication LED. When this LED is illuminated, it indicates a 5 V power to ADCs.

When using the P4 external connector, ensure that the L7, L8, R172, and R173 are not connected. These power supply options can be selected using the options in Table 4.

Clock

The AD7134 can either accept the master clock signal as a CMOS input or generate the master clock using the integrated oscillator with an external crystal.

See Table 5 for the different clock options to provide the master clock to the two AD7134 devices on the EVAL-AD7134FMCZ.

Reference

The AD7134 has a 4.096 V reference supply generated by the ADR444, which is a low noise reference.

LED

Status indicator LEDs display the state of the EVAL-AD7134FMCZ when illuminated, as described in Table 6.

CONNECTORS AND SOCKETS

The inputs and outputs can connect to the EVAL-AD7134FMCZ using the major connectors and sockets shown in Table 7.

Table 7. Connectors and Sockets

Connector	Function	Connector Type
J1	SMB connector for XTAL2_1 external clock input	Straight printed circuit board (PCB) mount SMB jack
J2 to J17	Analog input SMB terminals for Channel 0 to Channel 7	Straight PCB mount SMB jacks
P1, P7	8-pin connectors for the eight differential analog inputs	Fixed terminal blocks, 8-pin, 3.81 mm, 90°
P3	Benchtop power supply voltage input	Fixed terminal blocks, 2-pin 2.54 mm, 90°
P4	Benchtop power supply front-end voltage input and ground (0 V) to this connector	Fixed terminal blocks, 3-pin, 2.54 mm, 90°
P5, P9	Optional external connectors for driver, daughter board, Channel 0, and Channel 4	7-way, 2.54 mm vertical sockets
P6, P10	Optional external connectors for driver, daughter board, Channel 0, and Channel 4	7-way, 2.54 mm through-hole headers
P8	Connection to SDP-H1 board	160-pin, 10 mm, male, VITA 57 connector

SERIAL DATA INTERFACE

8-CHANNEL DATA

The EVAL-AD7134FMCZ has two AD7134 devices with a total of eight ADC channels running in parallel. The conversion output data is sent to the SDP-H1 board using 10 interface lines, which consist of eight data lines (four from each device), a clock signal (DCLK), and a frame control signal (controlled by ODR). Table 8 lists the two mode connections, and Figure 4 shows the two data interfaces.

Take care when configuring the ADCs. The DCLK and ODR must only be driven by one ADC at a time.

Ensure that JP16 and JP17 are not kept open together. Also ensure that JP14 and JP15 are not kept open together.

Table 8. Device Mode Options

Device 1	Device 2	Mode
Master Mode with DCLK Output	Slave	ODR and DCLK are generated by Device 1 and act as inputs for all other devices.
Slave Mode with DCLK Input	Slave	ODR and DCLK are generated by the digital host.

DAISY-CHAINING AND MINIMAL INPUT/OUTPUT CONFIGURATION

To configure the device in single-channel and two-channel daisy-chain configurations, use the R580 and R590 links. To set the device in minimal input/output mode, use the R600 and R610 links. The R580, R590, R600, and R610 links are not inserted on the board. Refer to the AD7134 data sheet for more details.

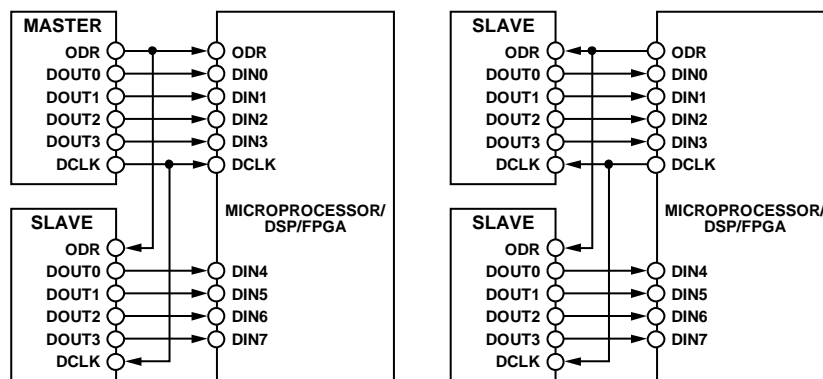

Figure 4. Data Interfaces

20895-005

CONFIGURATION CONTROL MODES

The AD7134 can be controlled either by configuring the pins or via the serial port interface (SPI), which is controlled using the PIN/SPI pin. The AD7134 is set either to SPI control mode or to pin control mode. The DEC0/DCLKIO, CLKSEL, MODE, and DEC1/DCLKMODE pins must be configured for pin control mode and SPI control mode. See Table 9 for the possible jumper configurations for these modes.

The configurations mentioned in Table 9 are mandatory for both pin control mode and SPI control mode. Use 10 k Ω resistors for the jumper links to set a specific pin.

PIN CONTROL MODE

The R132 resistor mounted with 10 k Ω enables pin control mode. R131 is not connected. When in pin control mode, use the hardware pins shown in Table 9 and Table 10 to set the device configuration and to run the AD7134 in standalone mode. See Table 10 for the pin control mode configuration options. Use 10 k Ω resistors for the resistors to set a pin.

SPI CONTROL MODE

The R131 resistor mounted with 10 k Ω enables SPI control mode. R132 is not connected. Use the SPI registers to set up the device for the desired configuration. The 4-wire or 3-wire SPI can be used to configure the device for all configurations except the PIN/SPI, DEC0/DCLKIO, CLKSEL, MODE, and DEC1/DCLKMODE pins.

Table 9. Jumper Configurations for Pin Control Mode and SPI Control Mode

Device	Pin Name	Jumper	High	Low	Default
Device 1 and Device 2	PIN/SPI	R131	Mounted	Not connected	Yes
		R132	Not connected	Mounted	No
Device 1 and Device 2	DEC1/DCLKMODE	R125	Mounted	Not connected	No
		R126	Not connected	Mounted	Yes
Device 1	MODE	JP16	Open	Closed	High
Device 1	CLKSEL	R133	Mounted	Not connected	Yes
		R134	Not connected	Mounted	No
Device 1	DEC0/DCLKIO	JP14	Open	Closed	High
Device 2	MODE	JP17	Open	Closed	Low
Device 2	CLKSEL	R135	Mounted	Not connected	Yes
		R136	Not connected	Mounted	No
Device 2	DEC0/DCLKIO	JP15	Open	Closed	Low

Table 10. Pin Control Mode Configurations

Device	Pin Name	Jumper	High	Low	Default
Device 1 and Device 2	DCLKRATE0/GPIO0	R91	Mounted	Not connected	No
		R92	Not connected	Mounted	Yes
Device 1 and Device 2	DCLKRATE1/GPIO1	R93	Mounted	Not connected	No
		R102	Not connected	Mounted	Yes
Device 1 and Device 2	DCLKRATE2/GPIO2	R103	Mounted	Not connected	No
		R104	Not connected	Mounted	Yes
Device 1 and Device 2	PWRMODE/GPIO3	R105	Mounted	Not connected	Yes
		R106	Not connected	Mounted	No
Device 1 and Device 2	FILTER0/GPIO4	R107	Mounted	Not connected	No
		R108	Not connected	Mounted	Yes
Device 1 and Device 2	FILTER1/GPIO5	R109	Mounted	Not connected	No
		R112	Not connected	Mounted	Yes
Device 1 and Device 2	FRAME0/GPIO6	R113	Mounted	Not connected	Yes
		R114	Not connected	Mounted	No
Device 1 and Device 2	FRAME1/GPIO7	R115	Mounted	Not connected	Yes
		R116	Not connected	Mounted	No
Device 1 and Device 2	FORMAT1/SCLK	R137	Mounted	Not connected	Yes
		R138	Not connected	Mounted	No

Device	Pin Name	Jumper	High	Low	Default
Device 1	FORMAT0/ $\overline{\text{CS}}$	R117	Mounted	Not connected	No
		R118	Not connected	Mounted	Yes
Device 2	FORMAT0/ $\overline{\text{CS}}$	R119	Mounted	Not connected	No
		R120	Not connected	Mounted	Yes
		R121	Mounted	Not connected	Yes
Device 1 and Device 2	DEC3/SDO	R122	Not connected	Mounted	No
		R123	Mounted	Not connected	No
Device 1 and Device 2	DEC2/SDI	R124	Not connected	Mounted	Yes
		R125	Mounted	Not connected	No
Device 1 and Device 2	DEC1/DCLKMODE	R126	Not connected	Mounted	Yes

EVALUATION BOARD SOFTWARE QUICK START PROCEDURES

SOFTWARE INSTALLATION

The AD7134 evaluation software installation package for the EVAL-AD7134FMCZ contains the evaluation application and the drivers for the SDP-H1 board.

Download the 32-bit National Instruments run-time engine Version 2019 SP1. Install this on the PC before installing the evaluation software.

Download the evaluation software from the AD7134 product page and install on a PC before using the EVAL-AD7134FMCZ.

Ensure that the SDP-H1 board is not connected to the PC during the installation process. To install the AD7134 evaluation software and SDP-H1 drivers, take the following steps:

1. Extract the zip file provided and double click the **setup.exe** file to begin the AD7134 evaluation software installation. Ensure that administrator access is available for the AD7134 evaluation software installation in the PC properties.
2. Click **Yes** in the **User Account Control** dialog box to permit the installer to create necessary directories and files (see Figure 5).

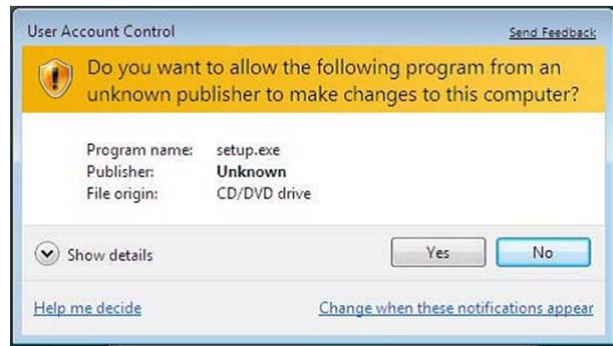

Figure 5. User Account Control Dialog Box

3. When the installer initializes, the **Destination Directory** dialog box appears (see Figure 6). Enter the desired path for installation and then click **Next**. The default path is **C:\Program Files (x86)\Analog Devices**.

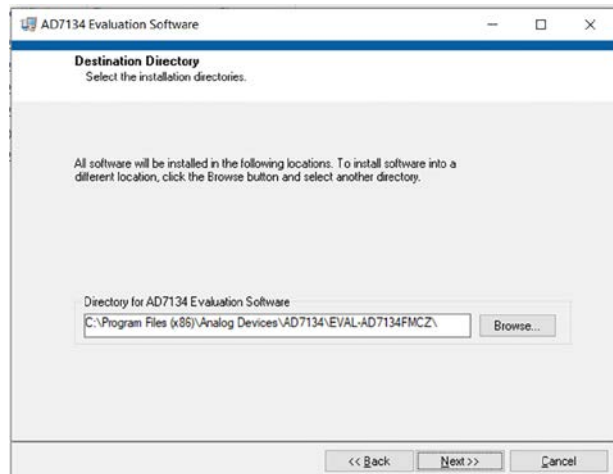

Figure 6. Setting Installation Destination Directories

4. The **License Agreement** dialog box appears, as shown in Figure 7. Read the agreement, select **I accept the License Agreement**, and then click **Next**.

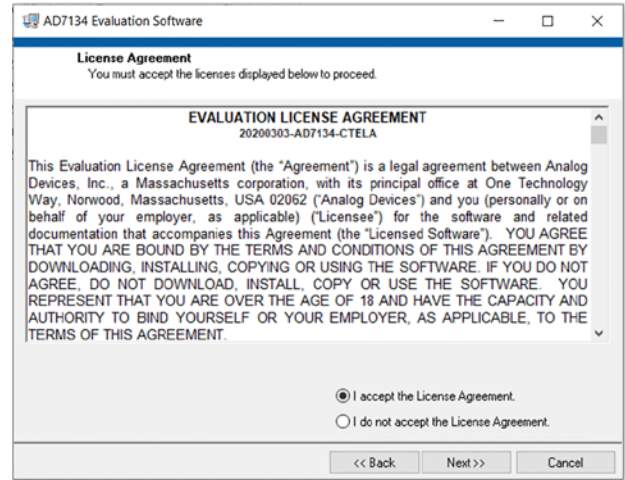

Figure 7. License Agreement

5. A summary of the installation appears, as shown in Figure 8. Click **Next** to continue.

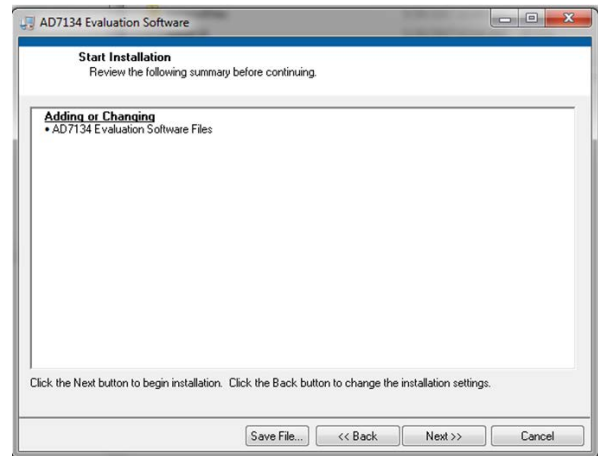

Figure 8. Installation Summary

6. A dialog box appears confirming a complete installation of the AD7134 evaluation software. Click **Next** to begin the SDP-H1 driver installation.
7. Ensure that the SDP-H1 board is disconnected from the PC and click **Next** when the SDP driver wizard appears (see Figure 9).

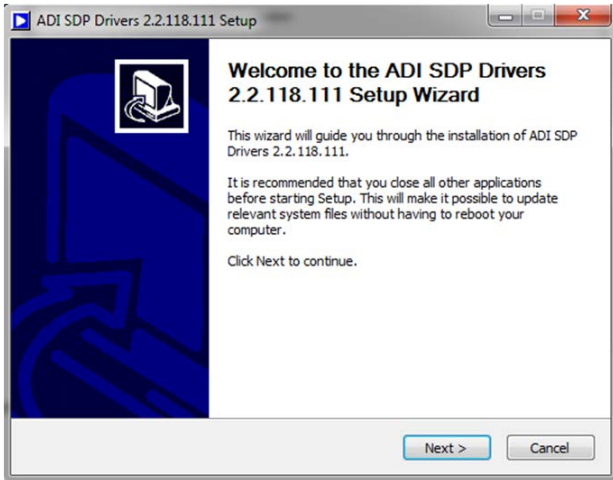

Figure 9. SDP-H1 Driver Setup

- Enter the desired path for the SDP-H1 drivers and click **Install** (see Figure 10).

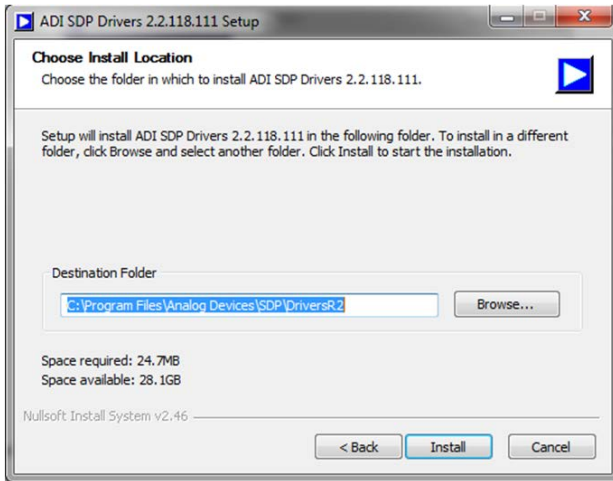

Figure 10. SDP-H1 Drivers Path

- The **Windows Security** dialog box appears (see Figure 11). Click **Install** to allow the **Windows Security** dialog box to install the SDP-H1 drivers.

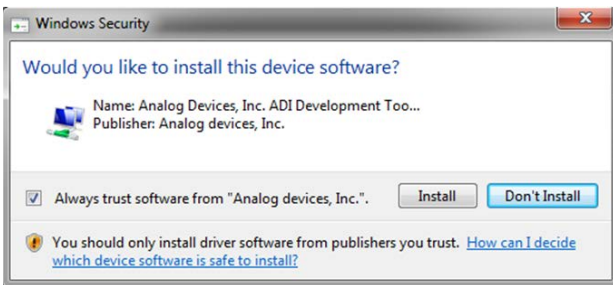

Figure 11. Windows Security Dialog Box

- When the driver installation is complete (see Figure 12), click **Close** to exit the installer and then restart the PC before using the EVAL-AD7134FMCZ.

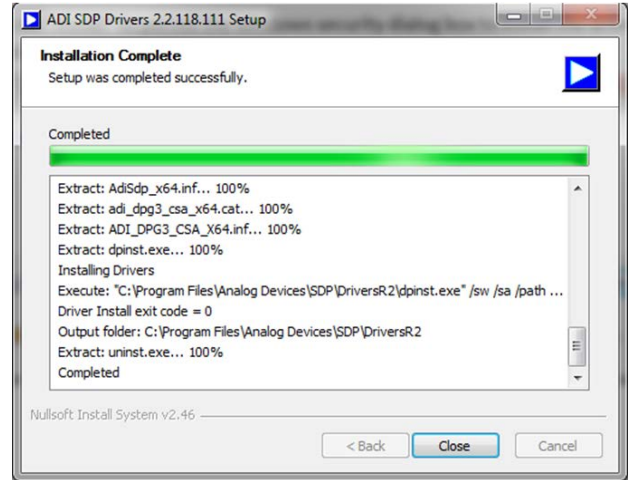

Figure 12. SDP-H1 Driver Installation Complete

USING THE SOFTWARE FOR TESTING

When the AD7134 evaluation software and SDP-H1 driver installation is complete, double click the EVAL-AD7134FMCZ evaluation software shortcut on the desktop (see Figure 13). When the shortcut opens, the application is ready to accept commands from the user. The application has four tabs: **Status**, **Registers**, **Waveform**, and **Analysis**.

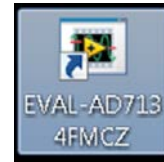

Figure 13. EVAL-AD7134FMCZ Evaluation Software Shortcut

Status Tab

When the application opens and starts running, the **Status** tab shows the set configuration of Device 1 and Device 2 by default (see Figure 14). The application initializes the ADCs and loads the register map for a default configuration. This process takes a few seconds to complete.

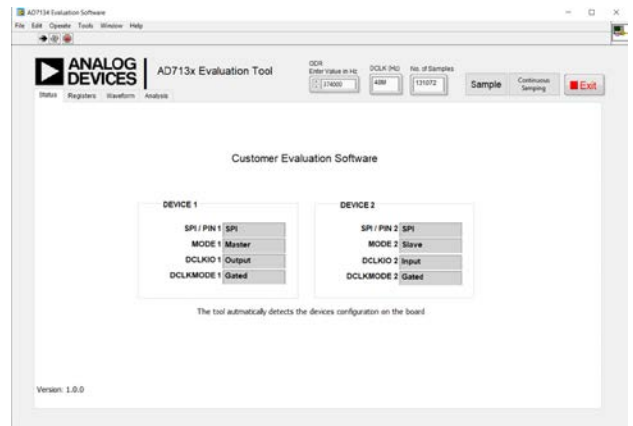

Figure 14. Status Tab

Registers Tab

All ADC register content appears as lists in the **Registers** tab (see Figure 15). The **Device Select** dropdown menu sets the device that corresponds to the register contents that appear in the **Registers** list. When a register is selected from the **Registers** list, the corresponding bit fields appear in the **Bit Field Definition** list. A description of the desired bit field is available in the **Bit Field Description** box. To update the contents of a register, click the individual bits in the **Write Value** box and then click the **Update** button to enter the contents. To update the contents of the **Registers** list with the current values contained in the ADC, click **Read All Registers**. Use the **Save** and **Load** buttons to write and read a register map file, respectively.

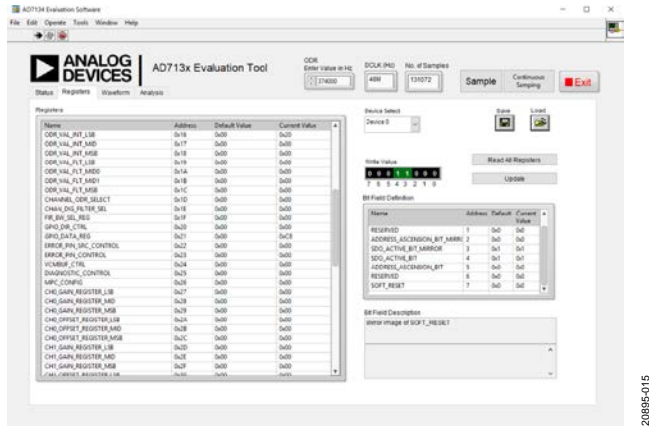

Figure 15. Registers Tab

Waveform Tab

The **Waveform** tab displays the data captured (see Figure 16). Select the check box next to the desired channel to see that specific channel data. To obtain specific measurement parameters of a channel, select the desired measurement from the **Analysis Channel** dropdown menu. Click **Sample** to obtain a set of values. Click **Continuous Sampling** to view continuous data capture.

The user can enter an output data rate (ODR) value into the **ODR Enter Value in Hz** box. The **DCLK (Hz)** box value is set to 48 MHz when Device 1 is in master mode and Device 2 is in slave mode, as shown in Figure 16. When both devices are in slave mode, the DCLK value is fixed to 48 MHz. Enter values into the **No. of Samples** box to set the number of samples captured per channel.



Figure 16. Waveform Tab

Analysis Tab

The **Analysis** tab shows the frequency spectrum and the required parameters pertaining to the channel selected in the **Analysis Channel** dropdown menu (see Figure 17).

To abort execution, click **Exit** in the top right corner of the window and close the application.

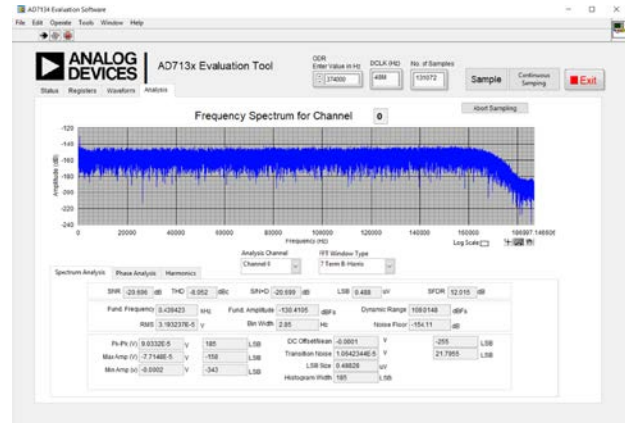
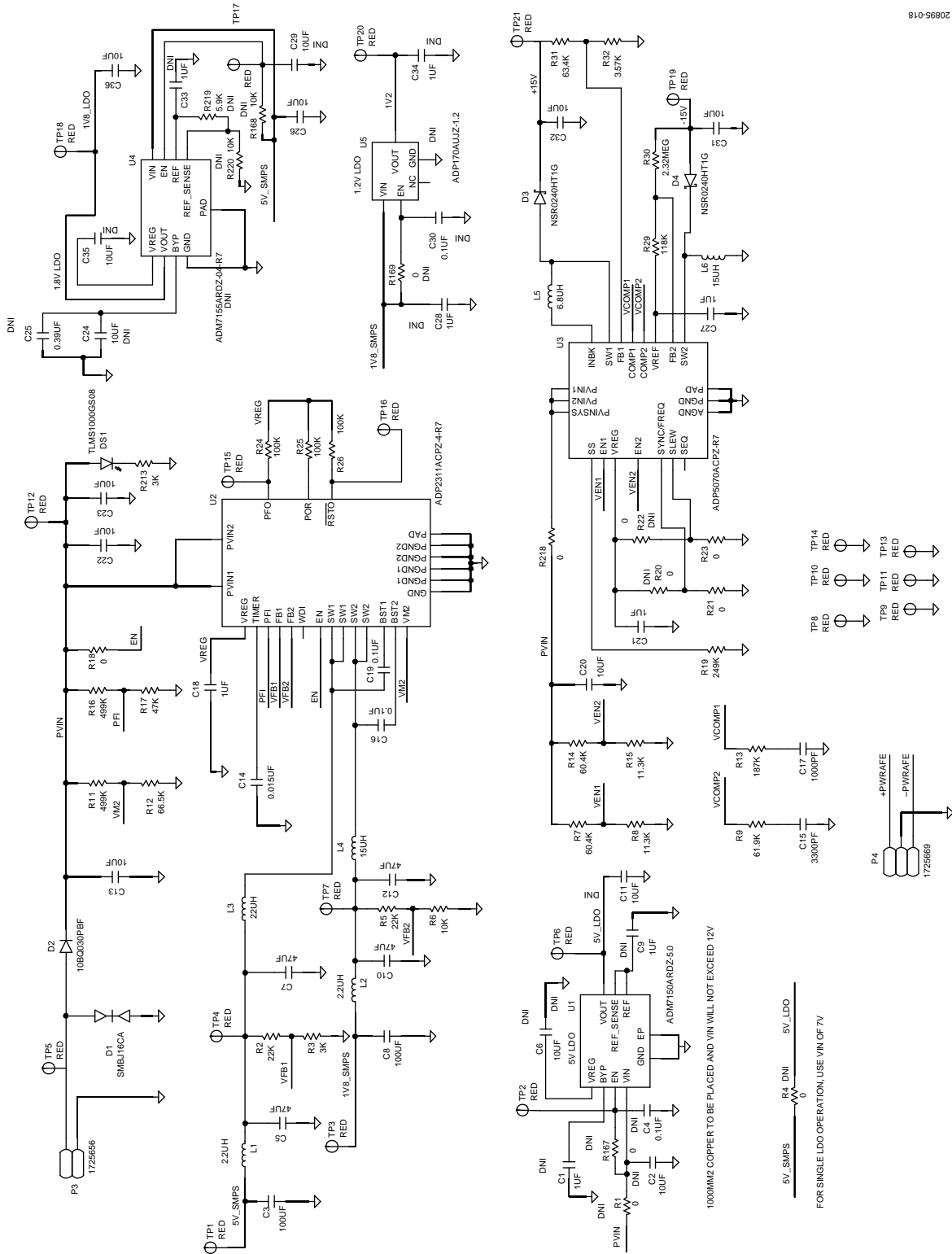

Figure 17. Analysis Tab

EVALUATION BOARD SCHEMATICS AND ARTWORK



20895-018

Figure 18. Power Supplies

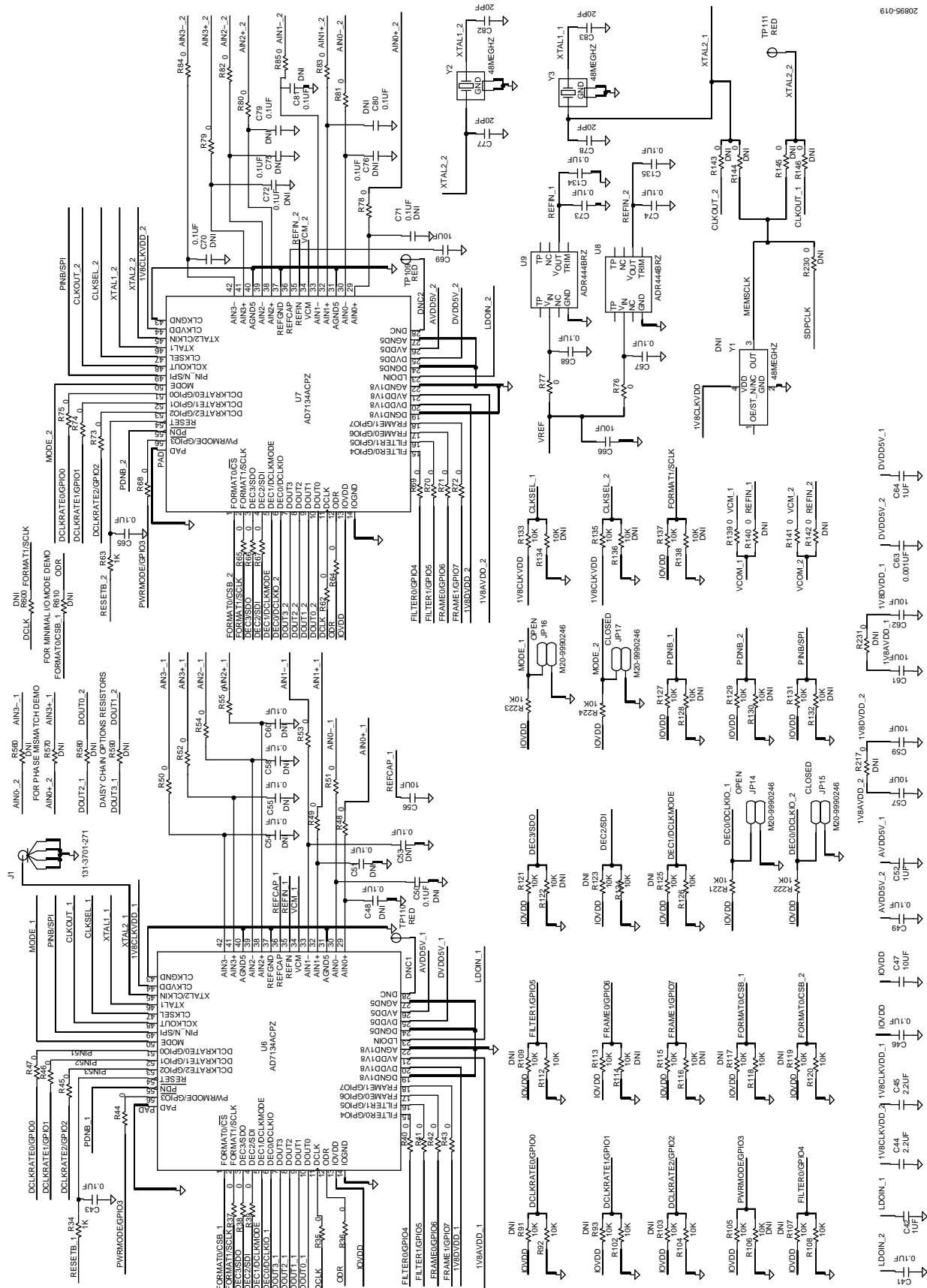

Figure 19. ADC Main Page

20895-020

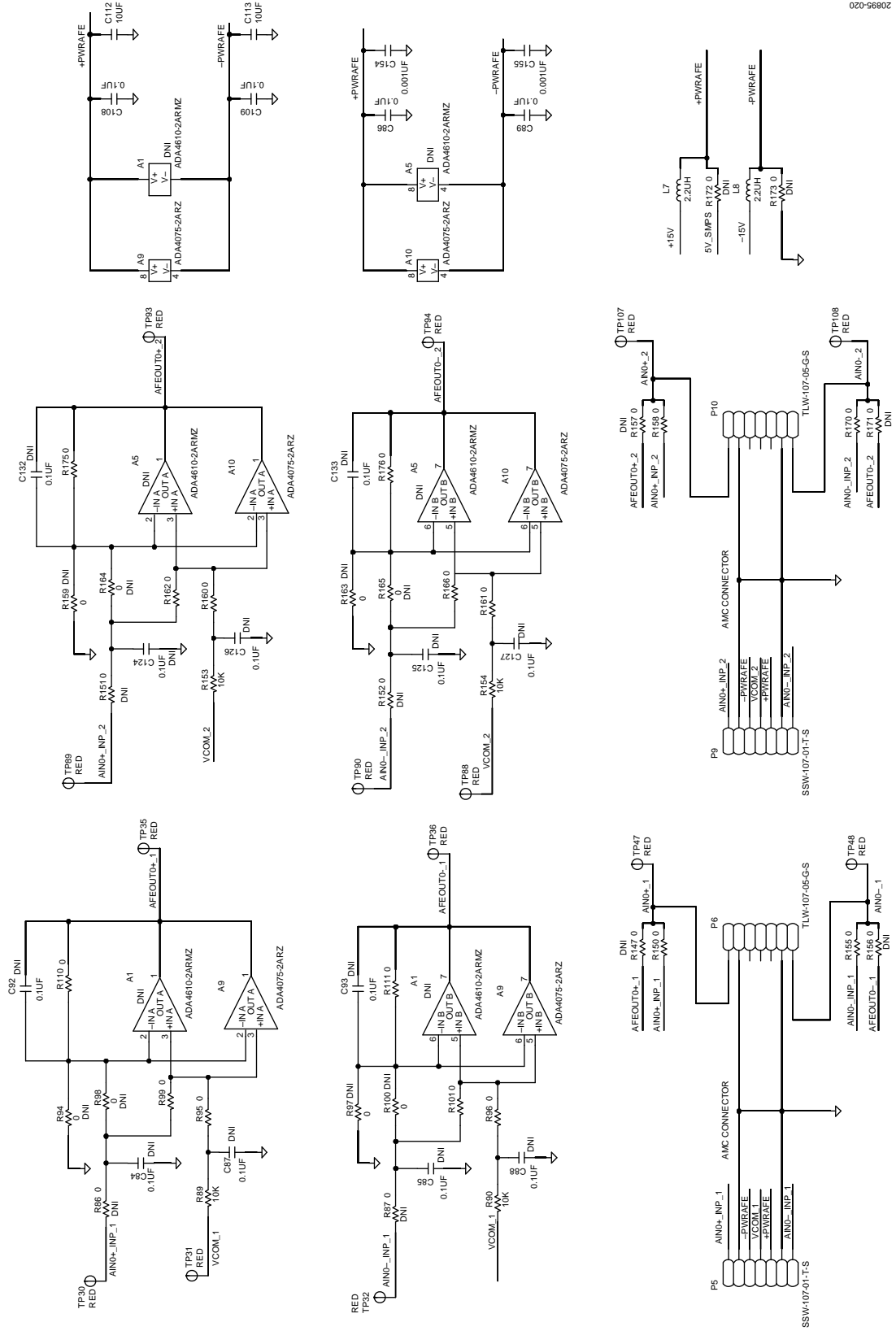

Figure 20. Front-End Section

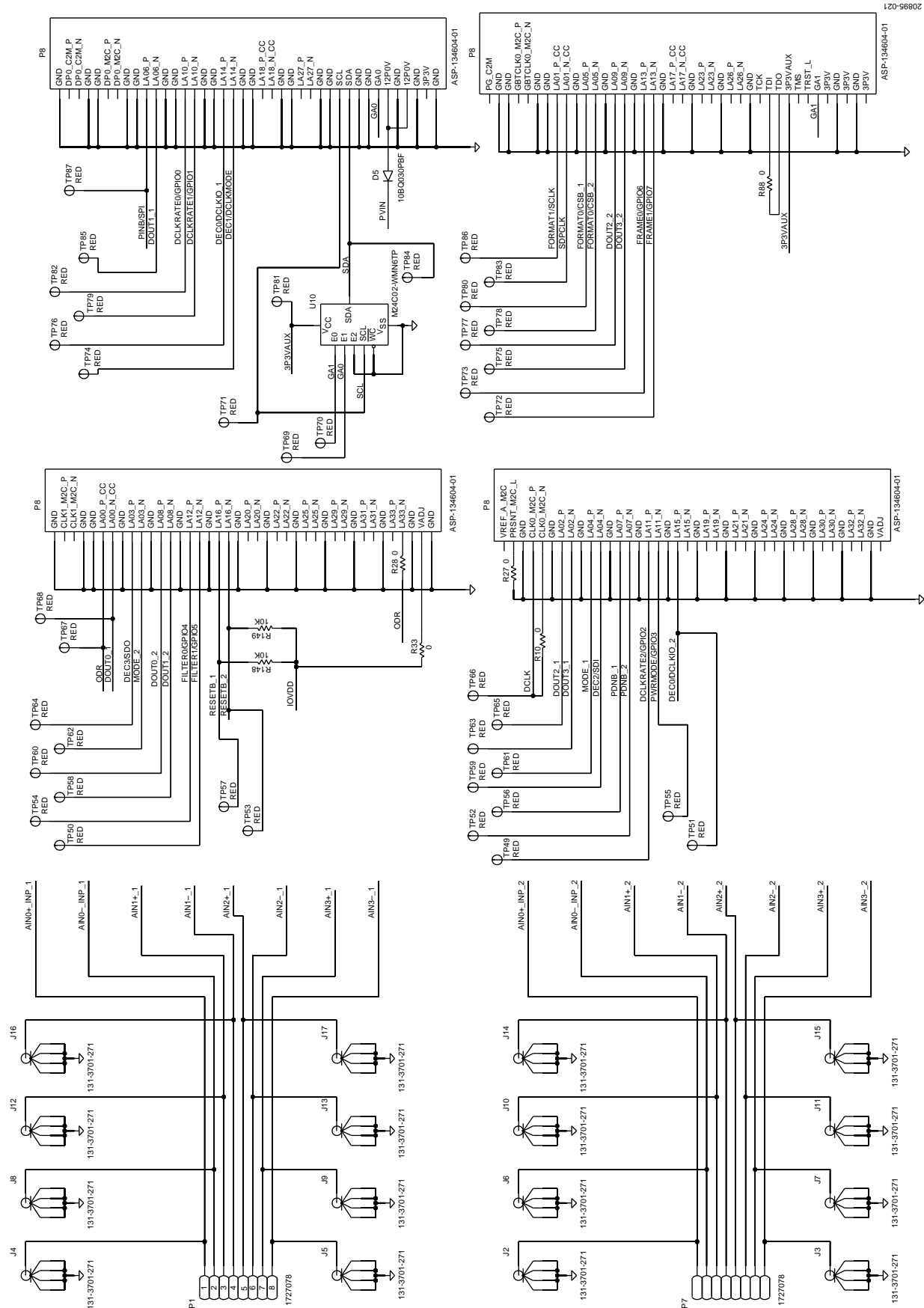

Figure 21. Input and Output Connectors
Rev. 0 | Page 16 of 22

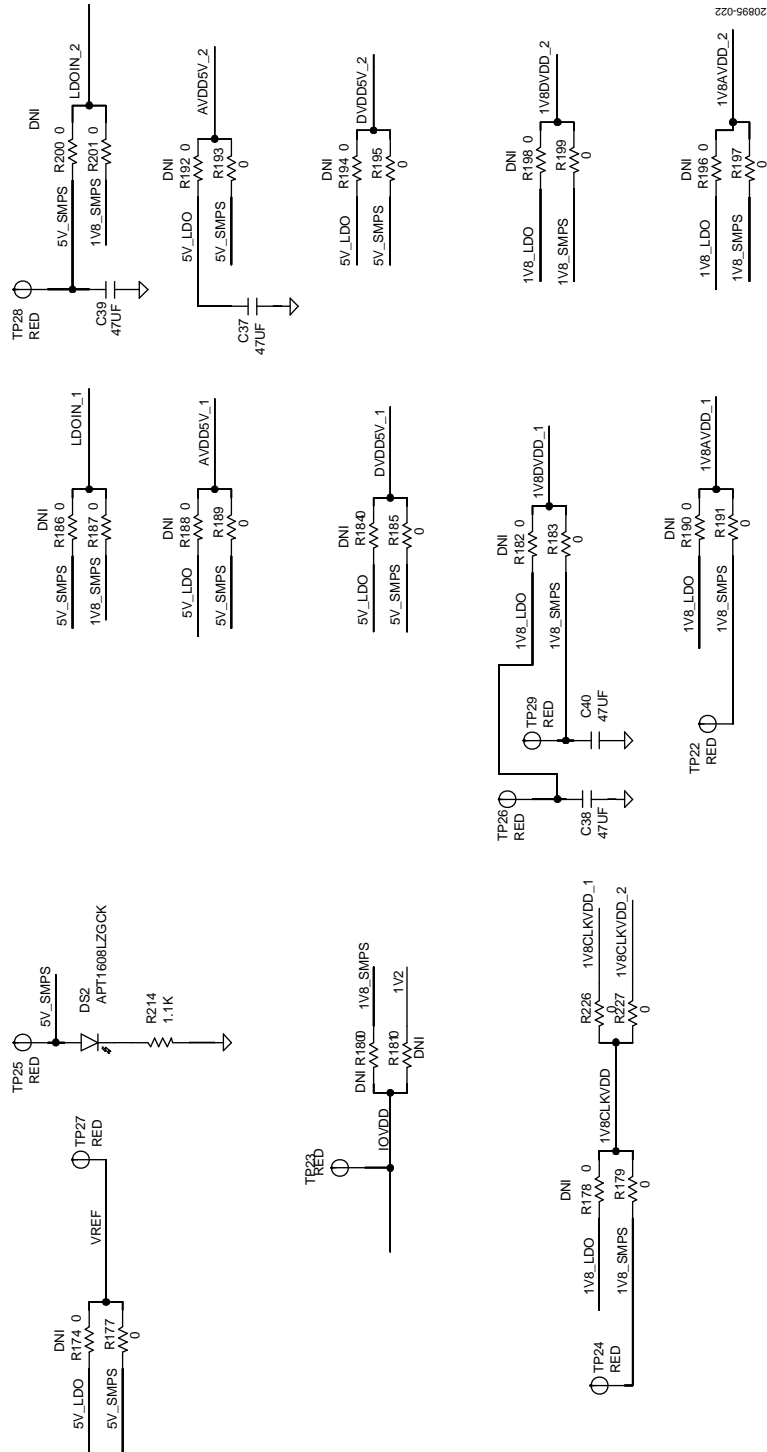

Figure 22. Power Link Options

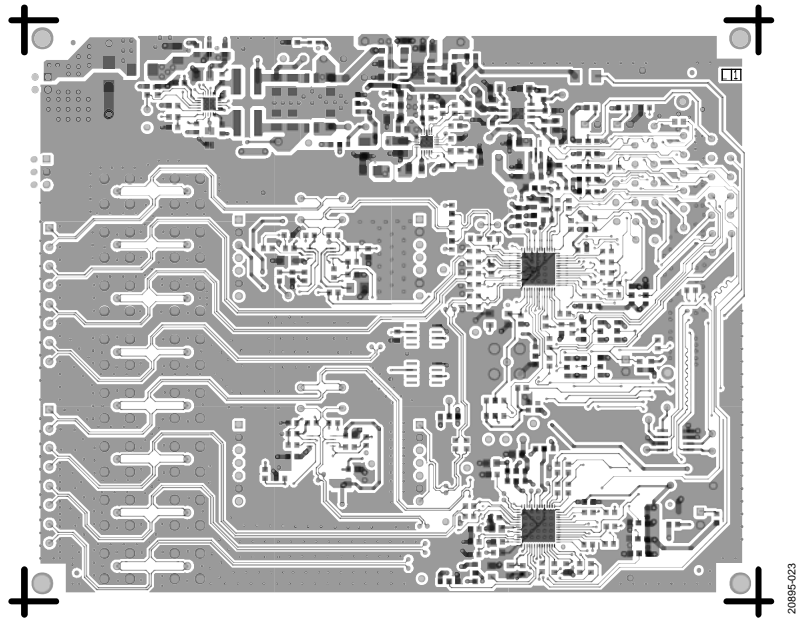

Figure 23. Layer 1, Primary Layer

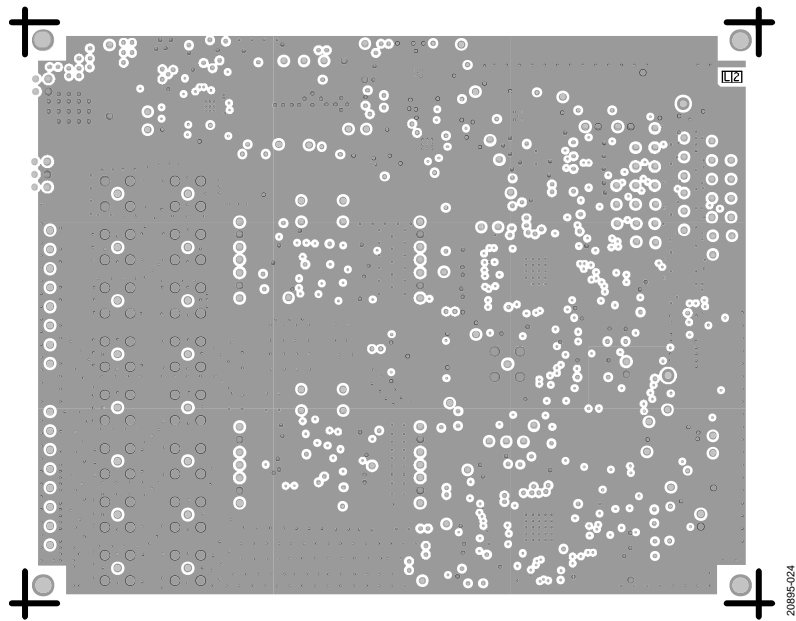

Figure 24. Layer 2, Ground Layer

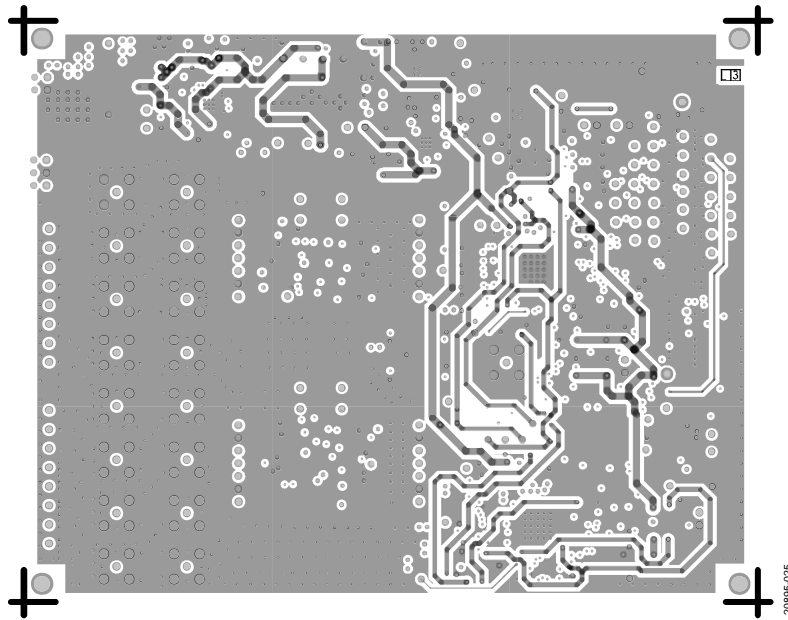

Figure 25. Layer 3, Supply Layer

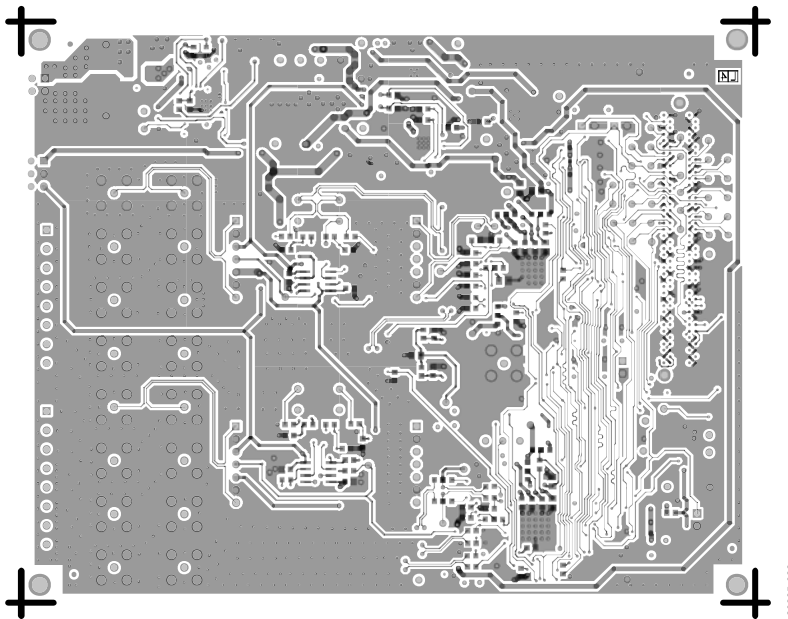

Figure 26. Layer 4, Bottom Layer

ORDERING INFORMATION

BILL OF MATERIALS

Table 11.

Qty	Reference Designator	Description	Manufacturer	Part Number
1	PCB	PCB Revision C	Analog Devices	EVAL-AD7134FMCZ
2	A9, A10	IC, ultralow noise amplifiers at lower power	Analog Devices	ADA4075-2ARZ
3	C1, C9, C28	Ceramic capacitors, X5R, general-purpose	Murata	GRM216R61E105KA12D
6	C112, C113, C57, C59, C61, C62	Ceramic capacitors, X7R, general-purpose	Murata	GRM31CR71E106KA12L
4	C5, C7, C10, C12	Ceramic capacitors, X5R, general-purpose	Murata	GRM31CR60J476ME19L
18	C4, C16, C19, C41, C43, C46, C49, C65, C67, C68, C73, C74, C108, C109, C134, C135, C150, C151	Ceramic capacitors, X7R, general-purpose	Murata	GRM188R71H104JA93D
8	C2, C6, C11, C26, C36, C56, C66, C69	Ceramic capacitors, X5R, general-purpose	Murata	GRM21BR61D106KE15L
3	C63, C154, C155	Ceramic capacitors, C0G (NP0), general-purpose	Murata	GRM1885C1H102JA01D
5	C13, C22, C23, C31, C32	Ceramic capacitors, X5R, general-purpose	Murata	GRM31CR61E106KA12L
1	C14	Ceramic capacitor, X7R, general-purpose	Murata	GRM188R71H153KA01D
1	C15	Ceramic capacitor, X7R	Yageo	2238 586 15629
1	C17	Ceramic capacitor, C0G, 0603	TDK	C1608C0G2A102J
1	C18	Ceramic capacitor, X5R, general-purpose	Murata	GRM188R61C105KA93D
1	C20	Ceramic capacitor, X7R	TDK	C3216X7R1C106M160AC
2	C21, C27	Ceramic capacitors, X5R, general-purpose	Murata	GRM188R61E105KA12D
2	C3, C8	Ceramic capacitors, X5R, general-purpose	Murata	GRM31CR60J107ME39L
4	C37 to C40	Ceramic capacitors, high value multilayer, X5R, 0805	Taiyo Yuden	JMK212BJ476MG-T
4	C42, C47, C52, C64	Ceramic capacitors, X7R	AVX	0603YC105KAT2A
2	C44, C45	Ceramic capacitors, X7R, general-purpose	Murata	GRM188R71A225KE15D
1	D1	Diode, transient voltage suppressor (TVS), bidirectional	Littelfuse	SMBJ16CA
2	D2, D5	Diodes, Schottky, rectifier, surface-mount diode (SMD)	International Rectifier	10BQ030PBF
2	D3, D4	Diodes, Schottky, barrier	ON Semiconductor	NSR0240HT1G
1	DS1	LED, SMD, 0603, red	Vishay	TLMS1000-GS08
1	DS2	LED, chip lamp, green, 525 nm (clear)	Kingbright Electronic	APT1608LZGCK
17	J1 to J17	PCB connectors, SMB, PC mount, jack receptacle	Cinch Connectivity Solutions, Inc.	131-3701-271
2	SL25, SL26	Resistors, spacer jumper solder pads, Link 2 to Link 3	TDK	GLFR1608T2R2M-LR
14	SL1 to SL3, SL5 to SL7, SL15 to SL18, SL21 to SL24	Resistors, spacer jumper solder pads, Link 2 to Link 3	Panasonic	ERJ-3GEY0R00V
9	JP1 to JP3, JP5, JP6, JP9, JP10, JP12, JP13	Resistors, spacer jumpers, 10 k Ω , Link 2 to Link 3	Panasonic	ERJ-3EKF1002V
4	SL8 to SL10, SL20	Resistors, spacer jumper solder pads, Link 1 to Link 2	Panasonic	ERJ-3GEY0R00V
10	JP4, JP7, JP8, JP11, JP27 to JP32	Resistors, spacer jumpers, 10 k Ω , Link 1 to Link 2	Panasonic	ERJ-3EKF1002V
2	JP14, JP16	PCB connectors, header, single-row, 2-way, open	Harwin	M20-9990246
2	JP15, JP17	PCB connectors, header, single-row, 2-way, closed	Harwin	M20-9990246
2	L1, L2	Thick film chip resistors	Panasonic	ERJ-6GEY0R00V
1	L3	Inductor, shielded power, 5.6 A, 0.05512 Ω , dc resistance (DCR)	Coilcraft Inc.	XAL6060-223MEB
1	L4	Inductor shielded power, 5.8 A, 0.03977 Ω DCR	Coilcraft Inc.	XAL6060-153MEB
1	L5	Inductor, shielded power	Murata	LQH32PN6R8NN0L
1	L6	Inductor, shielded power	Coilcraft Inc.	ME3220-153KLB
2	P1, P7	PCB connectors, terminal block, 8-position, green	Phoenix Contact	1727078
2	P6, P10	PCB connectors, header, low profile	Samtec	TLW-107-05-G-S

Qty	Reference Designator	Description	Manufacturer	Part Number
1	P3	PCB connector, terminal block, 2-position	Phoenix Contact	1725656
1	P4	PCB connector, terminal block, 2.54 mm, 3-position	Phoenix Contact	1725669
2	P5, P9	PCB connectors, 0.025 in, square post socket	Samtec	SSW-107-01-T-S
1	P8	PCB connector, single-ended array, male, 160-position, use alternate symbol for RF application	Samtec	ASP-134604-01
20	R18, R21, R23, R86, R87, R95, R96, R99, R101, R110, R111, R151, R152, R160 to R162, R166, R175, R176, R218	Film resistors, SMD, 0603	Panasonic	ERJ-3GEY0R00V
2	R11, R16	Precision thick film chip resistors	Panasonic	ERJ-3EKF4993V
1	R12	General-purpose chip resistor	Yageo	RC0603FR-0766K5
1	R13	Precision thick film chip resistor	Panasonic	ERJ-6ENF1873V
2	R7, R14	Precision thick film chip resistors	Panasonic	ERJ-6ENF6042V
2	R8, R15	Precision thick film chip resistors	Panasonic	ERJ-3EKF1132V
47	R33, R35 to R55, R62, R64 to R85, R226, R227	Standard thick film chip resistors	Vishay	CRCW06030000Z0EAHP
1	R17	General-purpose chip resistor	Yageo	RC0603FR-0747KL
1	R19	Precision thick film chip resistor	Panasonic	ERJ-3EKF2493V
2	R2, R5	Thick film chip resistors	Vishay	CRCW060322K0FKEA
2	R3, R213	Film resistors, SMD, 0603	Panasonic	ERJ-3GEYJ302V
1	R214	Thick film chip resistor	Bourns	CR0603-FX-1101ELF
3	R24 to R26	Thick film chip resistors	Bourns	CR0603-FX-1003ELF
1	R29	Precision thick film chip resistor	Panasonic	ERJ-3EKF1183V
1	R30	General-purpose chip resistor	Yageo	RC0805FR-072M32L
1	R31	Precision thick film chip resistor, R0603	Panasonic	ERJ-3EKF6342V
1	R32	Thick film chip resistor, standard	Vishay	CRCW08053K57FKEA
2	R34, R63	Thick film chip resistors	Multicomp (SPC)	MC0063W060311K
6	R89, R90, R148, R149, R153, R154	Film resistors, SMD, 0603	Panasonic	ERJ-3EKF1002V
5	R6, R221 to R224	Pulse proof, thick film chip resistors	Vishay	CRCW060310K0FKEAHP
1	R9	Precision thick film chip resistor	Panasonic	ERJ-3EKF6192V
85	TP1 to TP32, TP35, TP36, TP47 to TP90, TP93, TP94, TP107 to TP111	PCB connectors, test point, red	Keystone Electronics	5000
1	U10	IC, 2 kb, serial I ² C bus, electrically erasable programmable read only memory (EEPROM)	STMicroelectronics	M24C02-WMN6TP
1	U2	IC, 18 V, dual, 1 A synchronized, switching regulator	Analog Devices	ADP2311ACPZ
1	U3	IC, dc-to-dc switch regulator with independent positive and negative outputs	Analog Devices	ADP5070ACPZ-R7
2	U6, U7	IC, 24-bit, continuous time Σ - Δ ADCs	Analog Devices	AD7134ACPZ
2	U8, U9	Ultralow noise LDO regulators, junction field effect transistor (XFET) voltage references with current sink and source	Analog Devices	ADR444BRZ
2	Y2, Y3	IC crystal oscillators, 20 pF load capacitance	ECS	ECS-480-20-30B-DU

NOTES

I²C refers to a communications protocol originally developed by Philips Semiconductors (now NXP Semiconductors).

**ESD Caution**

ESD (electrostatic discharge) sensitive device. Charged devices and circuit boards can discharge without detection. Although this product features patented or proprietary protection circuitry, damage may occur on devices subjected to high energy ESD. Therefore, proper ESD precautions should be taken to avoid performance degradation or loss of functionality.

Legal Terms and Conditions

By using the evaluation board discussed herein (together with any tools, components documentation or support materials, the "Evaluation Board"), you are agreeing to be bound by the terms and conditions set forth below ("Agreement") unless you have purchased the Evaluation Board, in which case the Analog Devices Standard Terms and Conditions of Sale shall govern. Do not use the Evaluation Board until you have read and agreed to the Agreement. Your use of the Evaluation Board shall signify your acceptance of the Agreement. This Agreement is made by and between you ("Customer") and Analog Devices, Inc. ("ADI"), with its principal place of business at One Technology Way, Norwood, MA 02062, USA. Subject to the terms and conditions of the Agreement, ADI hereby grants to Customer a free, limited, personal, temporary, non-exclusive, non-sublicensable, non-transferable license to use the Evaluation Board FOR EVALUATION PURPOSES ONLY. Customer understands and agrees that the Evaluation Board is provided for the sole and exclusive purpose referenced above, and agrees not to use the Evaluation Board for any other purpose. Furthermore, the license granted is expressly made subject to the following additional limitations: Customer shall not (i) rent, lease, display, sell, transfer, assign, sublicense, or distribute the Evaluation Board; and (ii) permit any Third Party to access the Evaluation Board. As used herein, the term "Third Party" includes any entity other than ADI, Customer, their employees, affiliates and in-house consultants. The Evaluation Board is NOT sold to Customer; all rights not expressly granted herein, including ownership of the Evaluation Board, are reserved by ADI. CONFIDENTIALITY. This Agreement and the Evaluation Board shall all be considered the confidential and proprietary information of ADI. Customer may not disclose or transfer any portion of the Evaluation Board to any other party for any reason. Upon discontinuation of use of the Evaluation Board or termination of this Agreement, Customer agrees to promptly return the Evaluation Board to ADI. ADDITIONAL RESTRICTIONS. Customer may not disassemble, decompile or reverse engineer chips on the Evaluation Board. Customer shall inform ADI of any occurred damages or any modifications or alterations it makes to the Evaluation Board, including but not limited to soldering or any other activity that affects the material content of the Evaluation Board. Modifications to the Evaluation Board must comply with applicable law, including but not limited to the RoHS Directive. TERMINATION. ADI may terminate this Agreement at any time upon giving written notice to Customer. Customer agrees to return to ADI the Evaluation Board at that time. LIMITATION OF LIABILITY. THE EVALUATION BOARD PROVIDED HEREUNDER IS PROVIDED "AS IS" AND ADI MAKES NO WARRANTIES OR REPRESENTATIONS OF ANY KIND WITH RESPECT TO IT. ADI SPECIFICALLY DISCLAIMS ANY REPRESENTATIONS, ENDORSEMENTS, GUARANTEES, OR WARRANTIES, EXPRESS OR IMPLIED, RELATED TO THE EVALUATION BOARD INCLUDING, BUT NOT LIMITED TO, THE IMPLIED WARRANTY OF MERCHANTABILITY, TITLE, FITNESS FOR A PARTICULAR PURPOSE OR NON-INFRINGEMENT OF INTELLECTUAL PROPERTY RIGHTS. IN NO EVENT WILL ADI AND ITS LICENSORS BE LIABLE FOR ANY INCIDENTAL, SPECIAL, INDIRECT, OR CONSEQUENTIAL DAMAGES RESULTING FROM CUSTOMER'S POSSESSION OR USE OF THE EVALUATION BOARD, INCLUDING BUT NOT LIMITED TO LOST PROFITS, DELAY COSTS, LABOR COSTS OR LOSS OF GOODWILL. ADI'S TOTAL LIABILITY FROM ANY AND ALL CAUSES SHALL BE LIMITED TO THE AMOUNT OF ONE HUNDRED US DOLLARS (\$100.00). EXPORT. Customer agrees that it will not directly or indirectly export the Evaluation Board to another country, and that it will comply with all applicable United States federal laws and regulations relating to exports. GOVERNING LAW. This Agreement shall be governed by and construed in accordance with the substantive laws of the Commonwealth of Massachusetts (excluding conflict of law rules). Any legal action regarding this Agreement will be heard in the state or federal courts having jurisdiction in Suffolk County, Massachusetts, and Customer hereby submits to the personal jurisdiction and venue of such courts. The United Nations Convention on Contracts for the International Sale of Goods shall not apply to this Agreement and is expressly disclaimed.