

ALS30C682NT450

Aliases (A331TW682M450C)

ALS30, Aluminum Electrolytic, 6,800 uF, 20%, 450 VDC, -40/+85°C

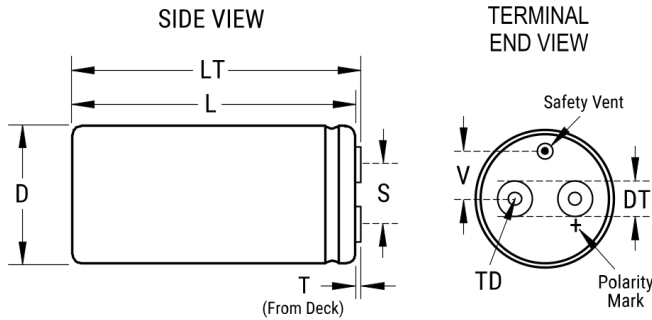

Click [here](#) for the 3D model.

Dimensions

D	77mm +/-1mm
L	220mm +/-2mm
T	5.5mm +/-0.5mm
S	31.8mm +/-0.5mm
DT	13mm +/-0.5mm
LT	Available On Request
TD	10mm MIN
V	19mm NOM

Packaging Specifications

Sleeving	Yes
Packaging	Bulk, Box

General Information

Series	ALS30
Dielectric	Aluminum Electrolytic
Description	Screw Terminal, Aluminum Electrolytic
RoHS	Yes
AEC-Q200	No
Component Weight	1450 g
Notes	Dimensions D And L Include Sleeving. MS (MxH) = M12x16. Mounting Clamp (Sold Separately): V11
Shelf Life	156 Weeks

Specifications

Capacitance	6,800 uF
Capacitance Tolerance	20%
Voltage DC	450 VDC, 495 VDC (Surge)
Temperature Range	-40/+85°C
Rated Temperature	85°C
Life	20000 Hrs (Rated Voltage And Ripple Current At 85C), 40000 Hrs (Rated Voltage At 85C)
Resistance	21 mOhms (100Hz 20C), 14 mOhms (10kHz 20C)
Ripple Current	27.4 Amps (100Hz 85C), 38.8 Amps (10kHz 85C)
Leakage Current	6000 uA (5min 20°C)