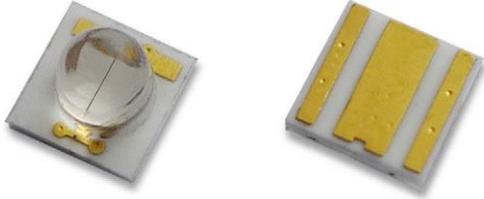


## UV SMD LED with Silicone Lens



### DESCRIPTION

VLMU3500-...-060... series is a ceramic based high power UV LED with silicone lens for long life time. The package size is 3.5 mm x 3.5 mm and the radiant power up to 1250 mW at 700 mA in a wavelength range of 380 nm to 410 nm.

### PRODUCT GROUP AND PACKAGE DATA

- Product group: LED
- Package: SMD ceramic high power
- Product series: high power UV LED
- Angle of half intensity:  $\pm 30^\circ$
- Lead-finishing: Au

### SAFETY ADVICES

Depending on the mode of operation, these devices emit highly concentrated non visible ultraviolet light which can be hazardous to the human eye. Products which incorporate these devices have to follow the safety precautions given in IEC 62471 "Photobiological Safety of Lamps and Lamp Systems".

### FEATURES

- Ceramic SMT package with silicone lens
- Dimension (L x W x H) in mm: 3.5 x 3.5 x 2.9
- Forward current: up to 700 mA
- Radiant power (typ.): 780 mW at 500 mA, 1037 mW at 700 mA
- Materials:
  - Die: InGaN
  - Resin: silicone (water clear)
  - Leads / terminations finish: gold plated (Au)
- Grouping parameters:
  - Radiant power
  - Peak wavelength
  - Forward voltage
- Reflow soldering method
- MSL2 according to J-STD-020
- Packaging: MOQ = 100 pieces; 12 mm tape with 100 pieces per reel,  $\varnothing$  180 mm (7")
- Material categorization: for definitions of compliance please see [www.vishay.com/doc?999912](http://www.vishay.com/doc?999912)



### APPLICATIONS

- Industrial curing
- Photocatalytic purification
- Poster printing curing
- Counterfeit money detector
- Blood detector
- Nail curing
- Teeth curing

### PARTS TABLE

PART	COLOR	RADIANT POWER (mW)			at I <sub>F</sub> (mA)	WAVELENGTH (nm)			at I <sub>F</sub> (mA)	FORWARD VOLTAGE (V)			at I <sub>F</sub> (mA)	TECHNOLOGY
		MIN.	TYP.	MAX.		MIN.	TYP.	MAX.		MIN.	TYP.	MAX.		
VLMU3500-385-060	Ultraviolet	620	780	940	500	380	385	390	500	2.8	3.4	4.0	500	InGaN
VLMU3500-385-060-L	Ultraviolet	620	780	940	500	380	385	390	500	2.8	3.4	4.0	500	InGaN
VLMU3500-395-060	Ultraviolet	620	780	940	500	390	395	400	500	2.8	3.4	4.0	500	InGaN
VLMU3500-395-060-L	Ultraviolet	620	780	940	500	390	395	400	500	2.8	3.4	4.0	500	InGaN
VLMU3500-405-060	Ultraviolet	620	780	940	500	400	405	410	500	2.8	3.4	4.0	500	InGaN
VLMU3500-405-060-L	Ultraviolet	620	780	940	500	400	405	410	500	2.8	3.4	4.0	500	InGaN

**ABSOLUTE MAXIMUM RATINGS** ( $T_{amb} = 25\text{ }^{\circ}\text{C}$ , unless otherwise specified)  
**VLMU3500-...-060...**

PARAMETER	TEST CONDITION	SYMBOL	VALUE	UNIT
DC forward current		$I_F$	700	mA
Power dissipation		$P_V$	2.8	W
Electrostatic discharge	HBM: MIL-STD-883 C 3B	ESD	8000	V
Junction temperature		$T_j$	+125	$^{\circ}\text{C}$
Operating temperature range		$T_{amb}$	-40 to +85	$^{\circ}\text{C}$
Storage temperature range		$T_{stg}$	-40 to +100	$^{\circ}\text{C}$
Solder temperature		$T_{sol}$	260	$^{\circ}\text{C}$
Thermal resistance - junction to solder point		$R_{thJS}$	8	$^{\circ}\text{C}/\text{W}$

**OPTICAL AND ELECTRICAL CHARACTERISTICS** ( $T_{amb} = 25\text{ }^{\circ}\text{C}$ , unless otherwise specified)  
**VLMU3500-...-060..., ULTRAVIOLET**

PARAMETER	TEST CONDITION	DEVICE TYPE	SYMBOL	MIN.	TYP.	MAX.	UNIT
Forward voltage	$I_F = 500\text{ mA}$		$V_F$	2.8	3.4	4	V
Radiant power	$I_F = 350\text{ mA}$		$\phi_e$	445	560	675	mW
	$I_F = 500\text{ mA}$			620	780	940	
	$I_F = 700\text{ mA}$			824	1037	1250	
Radiant intensity	$I_F = 350\text{ mA}$		$I_e$	-	395	-	mW/sr
	$I_F = 500\text{ mA}$			-	550	-	
	$I_F = 700\text{ mA}$			-	730	-	
Peak wavelength	$I_F = 500\text{ mA}$	VLMU3500-385-060...	$\lambda_p$	380	385	390	nm
		VLMU3500-395-060...		390	395	400	nm
		VLMU3500-405-060...		400	405	410	nm
Angle of half intensity	$I_F = 500\text{ mA}$		$\phi$	-	$\pm 30$	-	$^{\circ}$
Reverse current	$V_R = 5\text{ V}$		$I_R$	-	-	10	$\mu\text{A}$

**Note**

- Tolerances:  $\pm 11\%$  for  $\phi_e$ ,  $\pm 0.1\text{ V}$  for  $V_F$ ,  $\pm 1\text{ nm}$  for  $\lambda_p$

**RADIANT POWER CLASSIFICATION** ( $I_F = 500\text{ mA}$ )

GROUP	MIN.	MAX.	UNIT
U062	620	660	mW
U066	660	700	
U070	700	740	
U074	740	780	
U078	780	820	
U082	820	860	
U086	860	900	
U090	900	940	

**PEAK WAVELENGTH CLASSIFICATION** ( $I_F = 500\text{ mA}$ )

GROUP	MIN.	MAX.	UNIT
Q380	380	385	nm
Q385	385	390	
Q390	390	395	
Q395	395	400	
Q400	400	405	
Q405	405	410	

<b>FORWARD VOLTAGE CLASSIFICATION</b> ( $I_F = 500 \text{ mA}$ )			
GROUP	MIN.	MAX.	UNIT
V2830	2.8	3.0	V
V3032	3.0	3.2	
V3234	3.2	3.4	
V3436	3.4	3.6	
V3638	3.6	3.8	
V3840	3.8	4.0	

**Note**

- In order to ensure availability, single groups for radiant intensity, wavelength, and forward voltage will not be orderable. Only one group for radiant intensity, wavelength, and forward voltage will be shipped in any one reel

**MARKING EXAMPLE FOR SELECTION CODE ON LABEL**

Selection code: U074Q385V3436

- U074:  $\phi_e$ , range 740 mW to 780 mW
- Q385:  $\lambda_p$ , range 385 nm to 390 nm
- V3436:  $V_F$ , range 3.4 V to 3.6 V

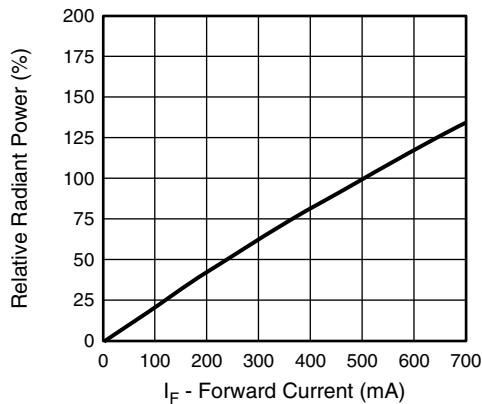
**TYPICAL CHARACTERISTICS** ( $T_{amb} = 25 \text{ }^\circ\text{C}$ , unless otherwise specified)


Fig. 1 - Relative Radiant Power vs. Forward Current

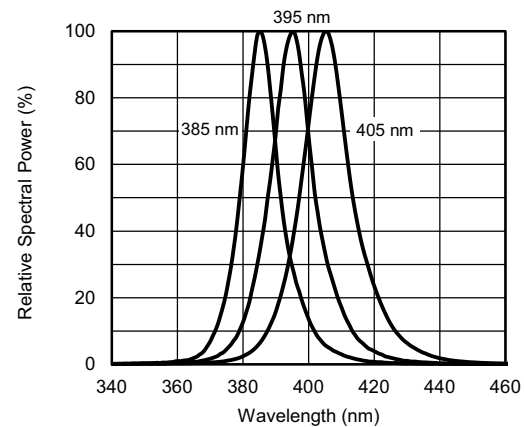


Fig. 3 - Relative Spectral Power vs. Wavelength

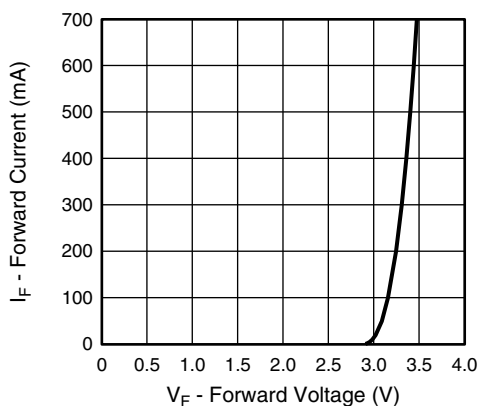


Fig. 2 - Forward Current vs. Forward Voltage

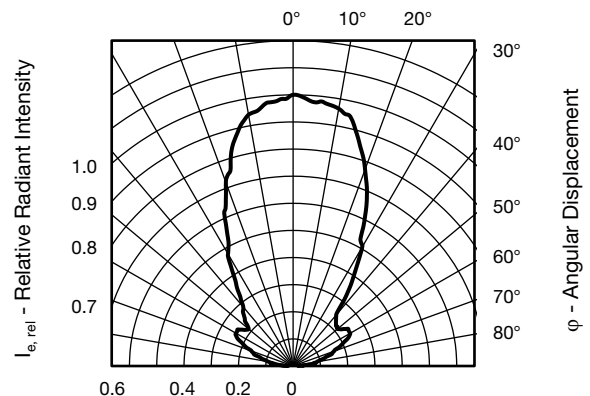


Fig. 4 - Relative Intensity vs. Angular Displacement

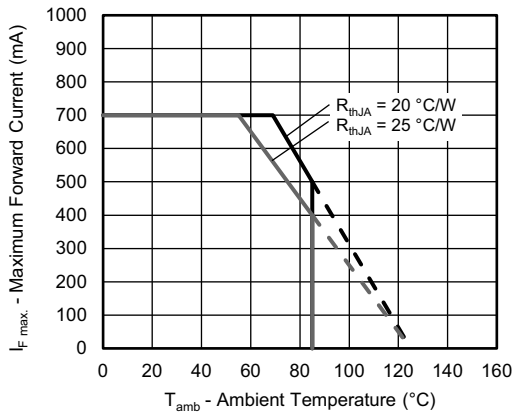


Fig. 5 - Maximum Forward Current vs. Ambient Temperature

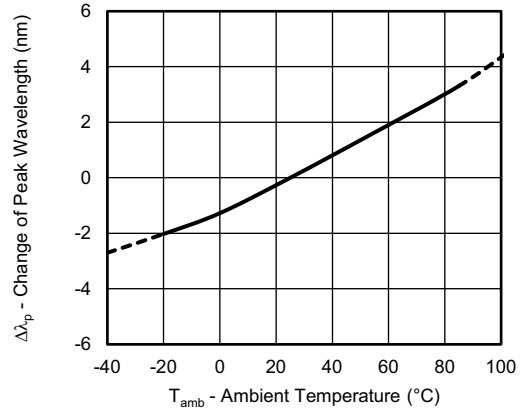


Fig. 7 - Change of Peak Wavelength vs. Ambient Temperature

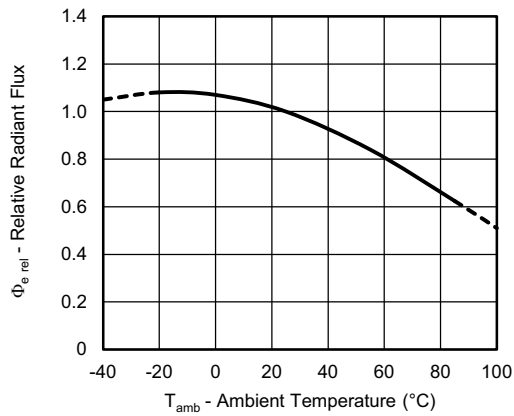


Fig. 6 - Relative Radiant Flux vs. Ambient Temperature

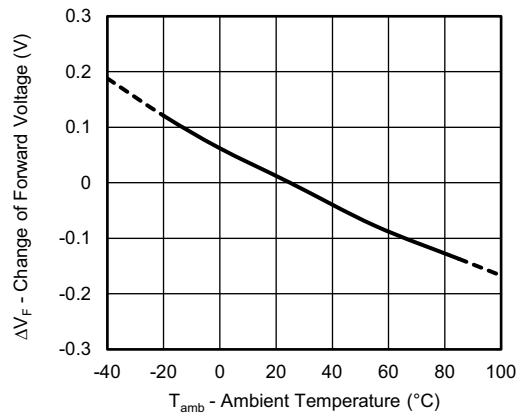
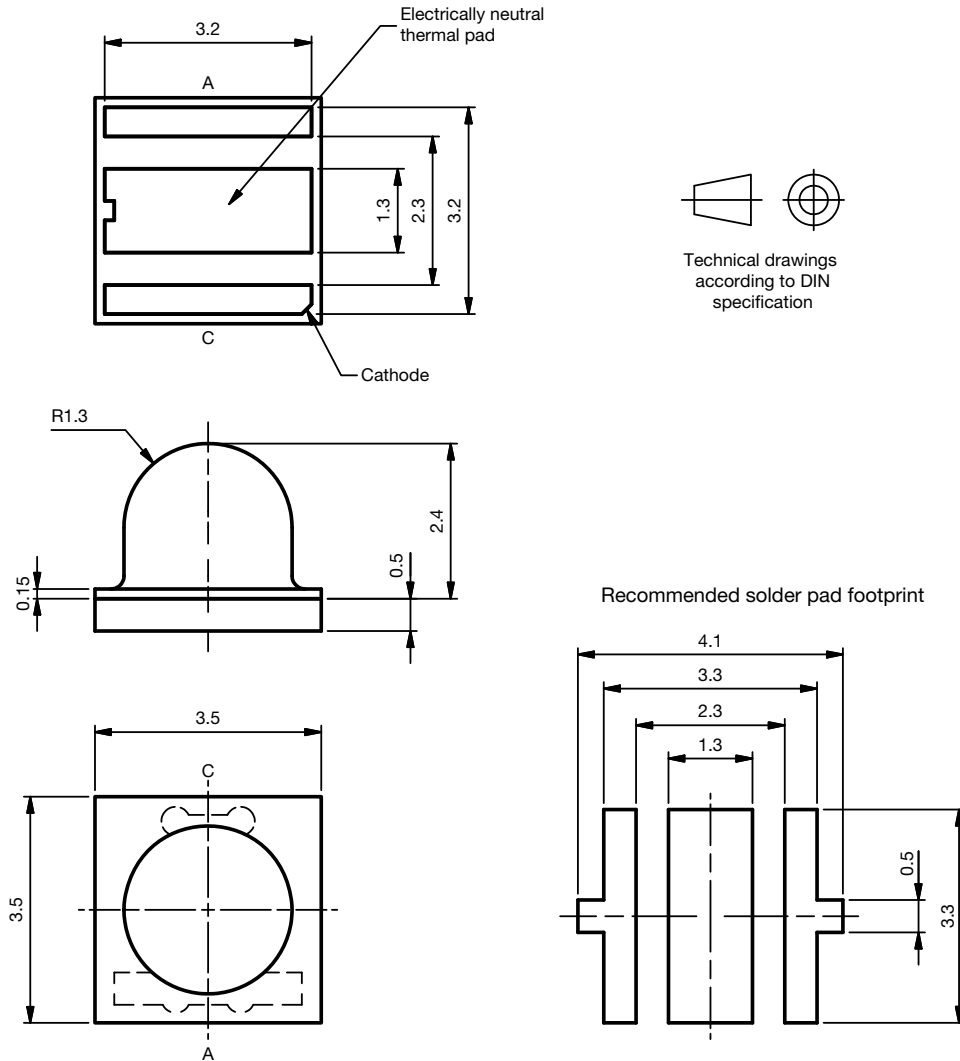


Fig. 8 - Change of Forward Voltage vs. Ambient Temperature

**PACKAGE DIMENSIONS** in millimeters



Drawing-No.: 6.541-5108.01-4  
Issue: 3VK; 26.11.2019

Not indicated tolerances  $\pm 0.13$

**WIRING**

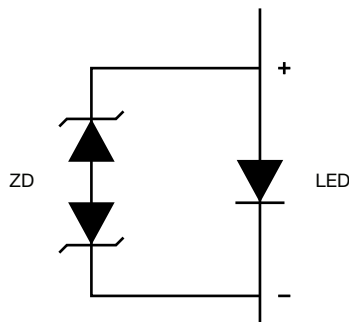
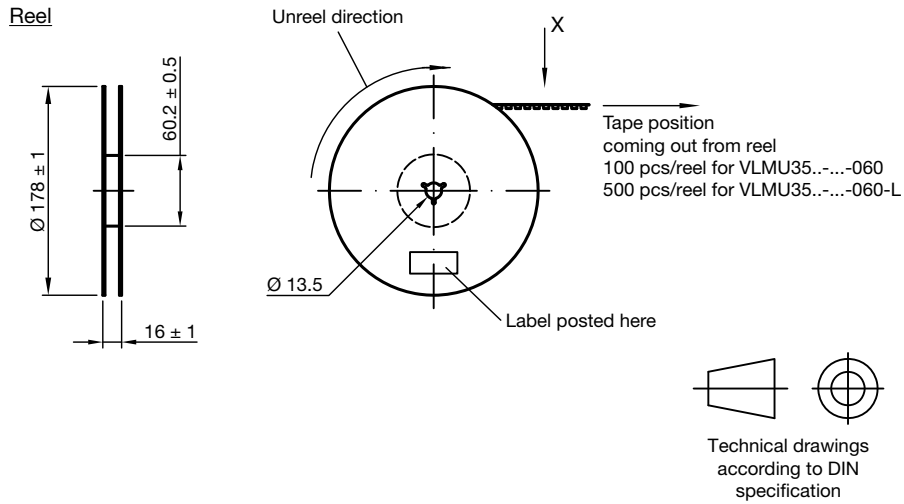
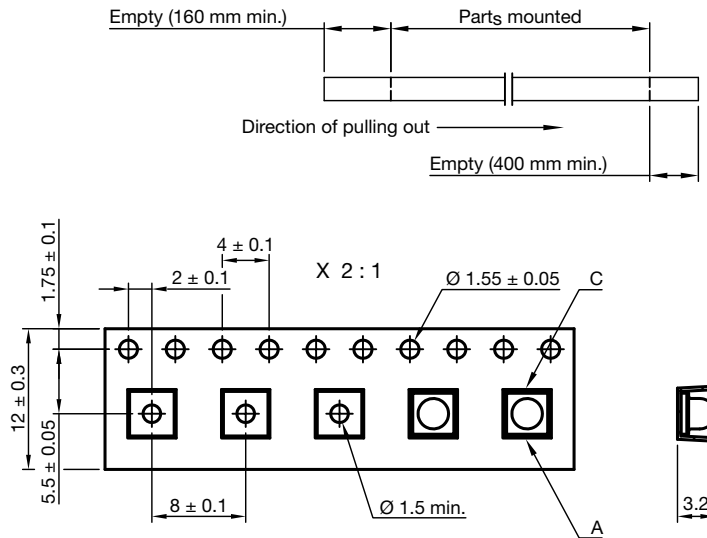


Fig. 9 - Wiring Diagram

**TAPE AND REEL DIMENSIONS** in millimeters



**Leader and trailer tape:**



Drawing-No.: 9.800-5131.01-4  
Issue: 2VK; 20.02.2020

**HANDLING RECOMMENDATIONS**

In order to achieve excellent lifetime, the package of these UV-LEDs consists of a ceramic substrate in combination with a UV stable silicone as lens material. Compared to standard materials silicone is generally softer and it tends more to attract dust:

- Minimize the level of dirt and dust particles in contact with the LED
- Small amounts of particles on the LEDs, although noticeable from a cosmetic point of view, do not affect the performance in terms of brightness, reliability and quality
- If cleaning is required, a short rinsing with isopropyl alcohol, not longer than 15 seconds, is recommended. Do not use ultrasonic cleaning, it may damage the LED
- Do not apply mechanical stress on the silicone lens
- Avoid any piercing of the silicone lens by sharp objects
- It is recommended to use a suitable pick and place tool for the removal of the LED from blister tape without applying stress to the lens. The recess of the pick-up needle has to be larger than the silicone lens
- For manual handling using tweezers make sure that the LED will be touched carefully at the sidewall of the ceramic substrate, but not at the silicone lens

**SOLDERING PROFILE**

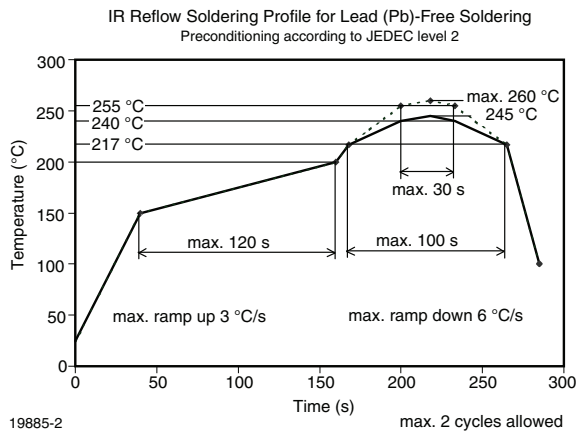
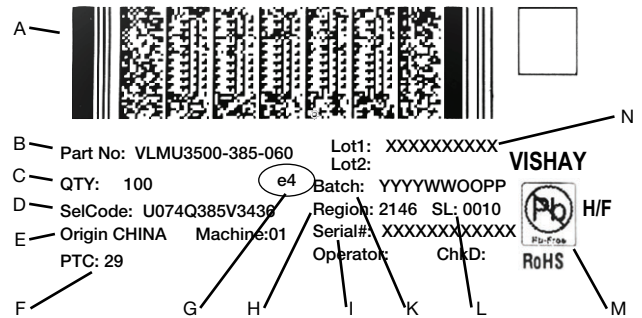


Fig. 10 - Vishay Lead (Pb)-free Reflow Soldering Profile (accord. to J-STD-020C)

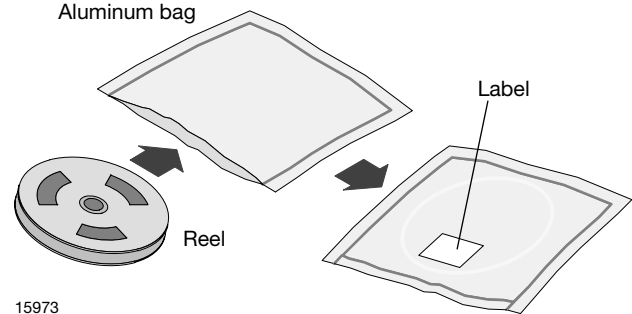
**BAR CODE PRODUCT LABEL (example only)**



- A. 2D barcode
- B. Part No: Vishay part number
- C. QTY: quantity
- D. SelCode: selection bin code
- E. Country of origin
- F. PTC: production plant code
- G. Termination finish
- H. Region code
- I. Serial#: serial number
- K. Batch Number: year, week, country code, plant code
- L. SL: sales location
- M. Environmental symbols: RoHS, lead (Pb)-free, halogen-free
- N. Lot numbers

**DRY PACKING**

The reel is packed in an anti-humidity bag to protect the devices from absorbing moisture during transportation and storage.



**FINAL PACKING**

The sealed reel is packed into a cardboard box. A secondary cardboard box is used for shipping purposes.



**RECOMMENDED METHOD OF STORAGE**

Dry box storage is recommended as soon as the aluminum bag has been opened to prevent moisture absorption. The following conditions should be observed, if dry boxes are not available:

- Storage temperature 10 °C to 30 °C
- Storage humidity ≤ 60 % RH max.

After more than 1 year under these conditions moisture content will be too high for reflow soldering.

In case of moisture absorption, the devices will recover to the former condition by drying under the following condition:

192 h at 40 °C + 5 °C / - 0 °C and < 5 % RH (dry air / nitrogen) or

24 h at 60 °C + 5 °C and < 5 % RH for all device containers or

24 h at 100 °C + 5 °C not suitable for reel or tubes.

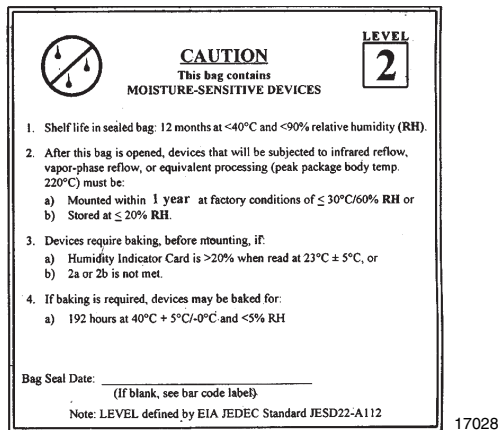
An EIA JEDEC® standard JESD22-A112 level 2 label is included on all dry bags.

**ESD PRECAUTION**

Proper storage and handling procedures should be followed to prevent ESD damage to the devices especially when they are removed from the antistatic shielding bag. Electrostatic sensitive devices warning labels are on the packaging.

**VISHAY SEMICONDUCTORS STANDARD BAR CODE LABELS**

The Vishay Semiconductors standard bar code labels are printed at final packing areas. The labels are on each packing unit and contain Vishay Semiconductors specific data.



Example of JESD22-A112 level 2 label





## Disclaimer

ALL PRODUCT, PRODUCT SPECIFICATIONS AND DATA ARE SUBJECT TO CHANGE WITHOUT NOTICE TO IMPROVE RELIABILITY, FUNCTION OR DESIGN OR OTHERWISE.

Vishay Intertechnology, Inc., its affiliates, agents, and employees, and all persons acting on its or their behalf (collectively, "Vishay"), disclaim any and all liability for any errors, inaccuracies or incompleteness contained in any datasheet or in any other disclosure relating to any product.

Vishay makes no warranty, representation or guarantee regarding the suitability of the products for any particular purpose or the continuing production of any product. To the maximum extent permitted by applicable law, Vishay disclaims (i) any and all liability arising out of the application or use of any product, (ii) any and all liability, including without limitation special, consequential or incidental damages, and (iii) any and all implied warranties, including warranties of fitness for particular purpose, non-infringement and merchantability.

Statements regarding the suitability of products for certain types of applications are based on Vishay's knowledge of typical requirements that are often placed on Vishay products in generic applications. Such statements are not binding statements about the suitability of products for a particular application. It is the customer's responsibility to validate that a particular product with the properties described in the product specification is suitable for use in a particular application. Parameters provided in datasheets and / or specifications may vary in different applications and performance may vary over time. All operating parameters, including typical parameters, must be validated for each customer application by the customer's technical experts. Product specifications do not expand or otherwise modify Vishay's terms and conditions of purchase, including but not limited to the warranty expressed therein.

Hyperlinks included in this datasheet may direct users to third-party websites. These links are provided as a convenience and for informational purposes only. Inclusion of these hyperlinks does not constitute an endorsement or an approval by Vishay of any of the products, services or opinions of the corporation, organization or individual associated with the third-party website. Vishay disclaims any and all liability and bears no responsibility for the accuracy, legality or content of the third-party website or for that of subsequent links.

Except as expressly indicated in writing, Vishay products are not designed for use in medical, life-saving, or life-sustaining applications or for any other application in which the failure of the Vishay product could result in personal injury or death. Customers using or selling Vishay products not expressly indicated for use in such applications do so at their own risk. Please contact authorized Vishay personnel to obtain written terms and conditions regarding products designed for such applications.

No license, express or implied, by estoppel or otherwise, to any intellectual property rights is granted by this document or by any conduct of Vishay. Product names and markings noted herein may be trademarks of their respective owners.