

## 1A, 200V - 600V Miniature Ultrafast Glass Passivated Bridge Rectifiers

### FEATURES

- Ideal for automated placement, for compact PCB design
- High surge current capability
- Ultrafast reverse recovery time for high frequency
- Negligible leakage current
- Compliant to RoHS Directive 2011/65/EU and in accordance to WEEE 2002/96/EC
- Halogen-free according to IEC 61249-2-21

**ABS**

### TYPICAL APPLICATIONS

General purpose rectification for AC/DC bridge full wave rectification for SMPS. PFC function for LED lighting ballast. Also suitable for secondary stage of high frequency inverters.

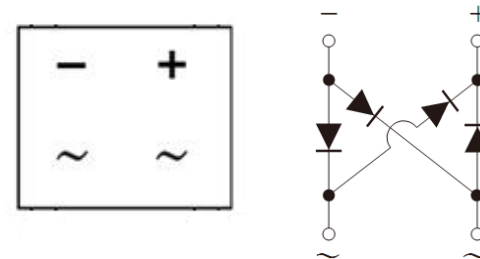

### MECHANICAL DATA

**Case:** Molded plastic body

Molding compound, UL flammability classification rating 94V-0

Moisture sensitivity level: level 1, per J-STD-020

Part no. with suffix "H" means AEC-Q101 qualified

Packing code with suffix "G" means green compound (halogen-free)

**Terminal:** Matte tin plated leads, solderable per JESD22-B102

Meet JESD 201 class 2 whisker test

**Polarity:** Polarity as marked on the body

**Weight:** 0.09 g (approximately)

MAXIMUM RATINGS AND ELECTRICAL CHARACTERISTICS (T <sub>A</sub> =25°C unless otherwise noted)					
PARAMETER	SYMBOL	EABS1D	EABS1G	EABS1J	UNIT
Maximum repetitive peak reverse voltage	V <sub>RRM</sub>	200	400	600	V
Maximum RMS voltage	V <sub>RMS</sub>	140	280	420	V
Maximum DC blocking voltage	V <sub>DC</sub>	200	400	600	V
Maximum average forward rectified current	I <sub>F(AV)</sub>	1			A
Peak forward surge current, 8.3 ms single half sine-wave superimposed on rated load	I <sub>FSM</sub>	40			A
Rating for fusing (t<8.3ms)	I <sup>2</sup> t	6.64			A <sup>2</sup> s
Maximum instantaneous forward voltage (Note 1) I <sub>F</sub> = 1 A	V <sub>F</sub>	0.95	1.20	1.70	V
Maximum reverse current @ rated V <sub>R</sub> T <sub>J</sub> =25°C T <sub>J</sub> =125°C	I <sub>R</sub>	1 200			μA
Maximum reverse recovery time (Note 2)	t <sub>rr</sub>	35			ns
Typical thermal resistance	R <sub>θJL</sub> R <sub>θJA</sub>	25 80			°C/W
Operating junction temperature range	T <sub>J</sub>	- 55 to +150			°C
Storage temperature range	T <sub>STG</sub>	- 55 to +150			°C

Note 1: Pulse test with PW=300μs, 1% duty cycle

Note 2: Reverse Recovery Test Conditions: I<sub>F</sub>=0.5A, I<sub>R</sub>=1.0A, I<sub>rr</sub>=0.25A

**ORDERING INFORMATION**

PART NO.	PART NO. SUFFIX	PACKING CODE	PACKING CODE SUFFIX	PACKAGE	PACKING
EABS1x (Note 1)	H	RE	G	ABS	1,000 / 7" Plastic reel
		RG		ABS	5,000 / 13" Paper reel

Note 1: "x" defines voltage from 200V (EABS1D) to 600V (EABS1J)

Note 2: Whole series with green compound

**EXAMPLE**

PREFERRED P/N	PART NO.	PART NO. SUFFIX	PACKING CODE	PACKING CODE SUFFIX	DESCRIPTION
EABS1DHREG	EABS1D	H	RE	G	AEC-Q101 qualified Green compound

**RATINGS AND CHARACTERISTICS CURVES**

(T<sub>A</sub>=25°C unless otherwise noted)

FIG.1 MAXIMUM FORWARD CURRENT DERATING CURVE

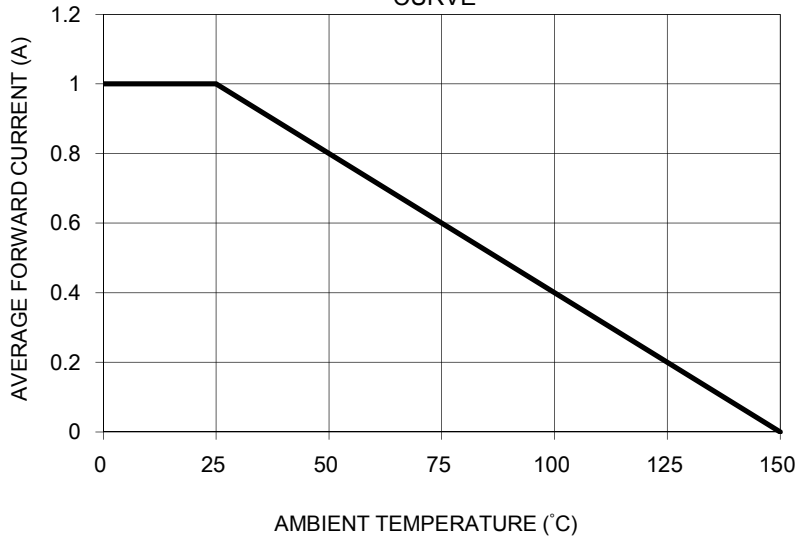

FIG. 2 TYPICAL REVERSE CHARACTERISTICS

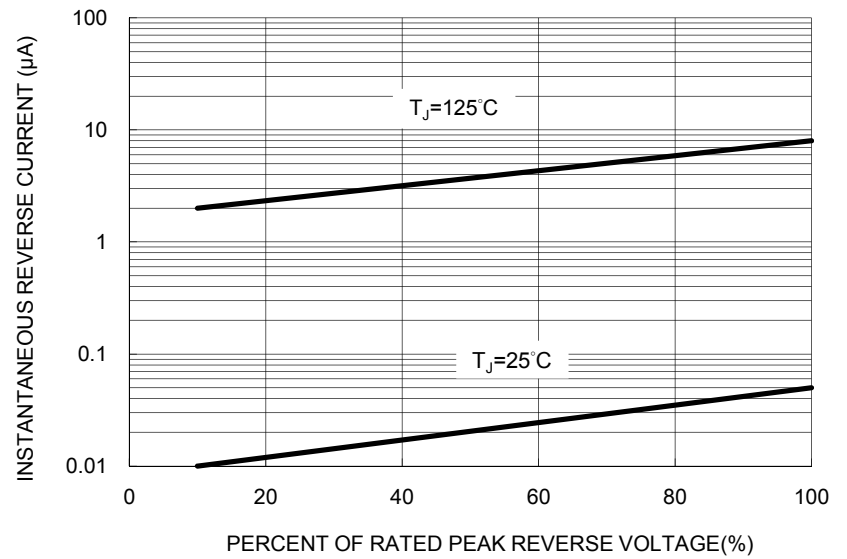

FIG. 3 MAXIMUM NON-REPETITIVE FORWARD SURGE CURRENT

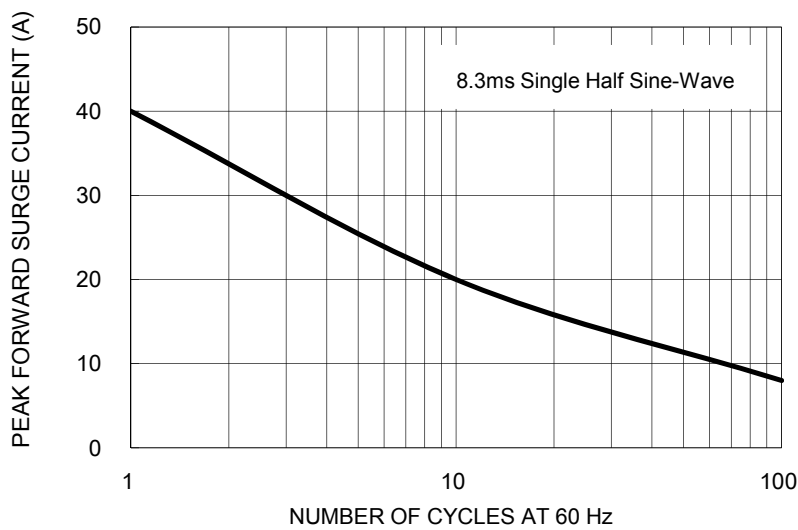

FIG. 4 TYPICAL JUNCTION CAPACITANCE

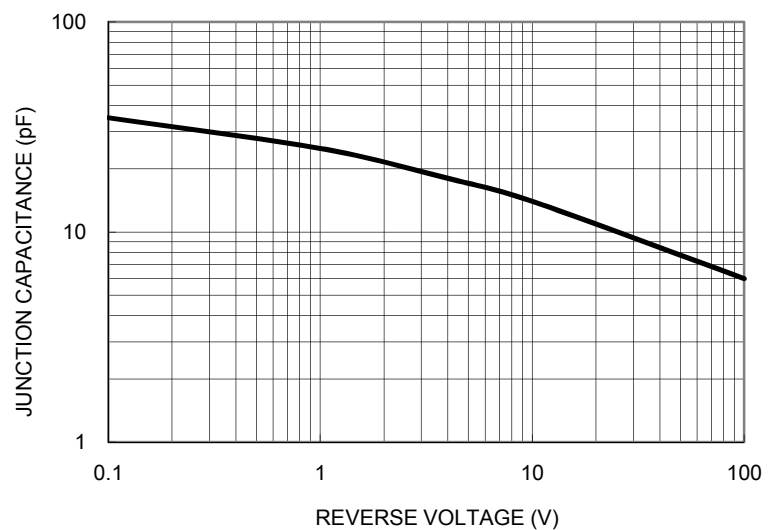
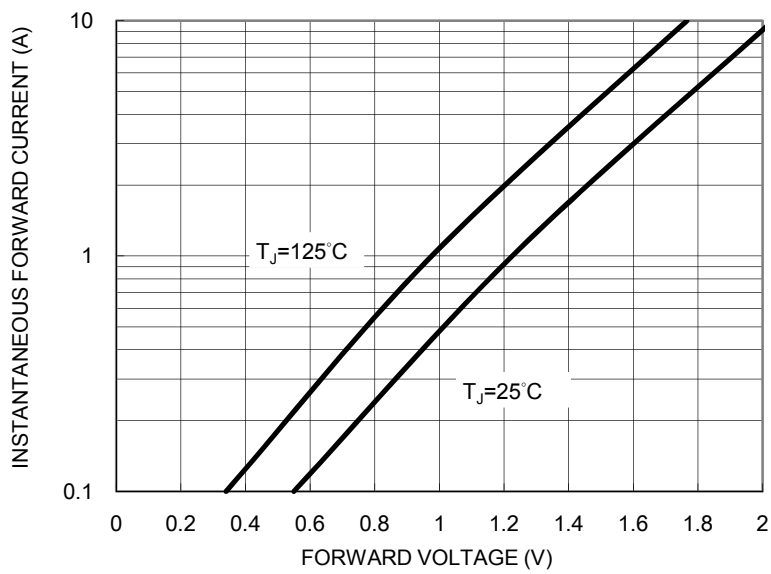
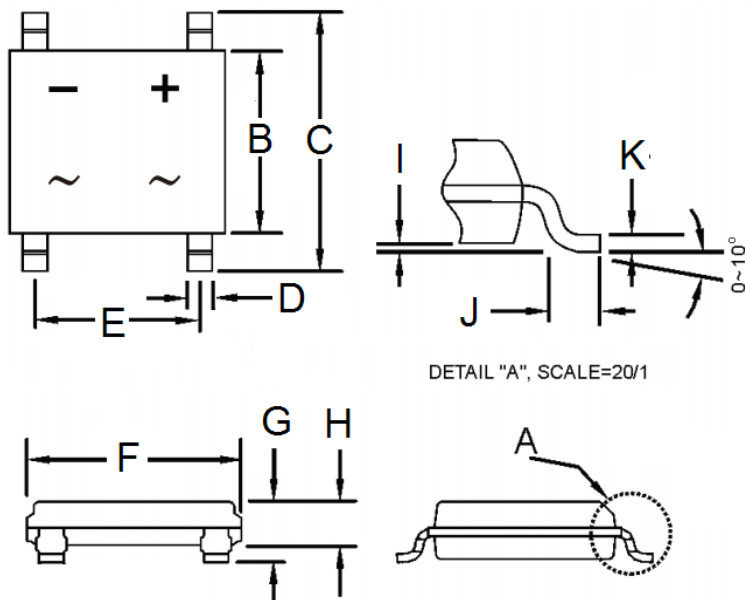

FIG. 5 TYPICAL FORWARD CHARACTERISTICS



PACKAGE OUTLINE DIMENSIONS

**ABS**



DIM.	Unit (mm)		Unit (inch)	
	Min	Max	Min	Max
B	4.30	4.50	0.169	0.177
C	6.25	6.65	0.246	0.262
D	0.60	0.70	0.024	0.028
E	3.90	4.10	0.154	0.161
F	4.90	5.10	0.193	0.200
G	1.40	1.60	0.055	0.063
H	1.35	1.45	0.053	0.057
I	0.05	0.15	0.002	0.006
J	0.30	0.70	0.012	0.028
K	0.15	0.25	0.006	0.010

SUGGESTED PAD LAYOUT

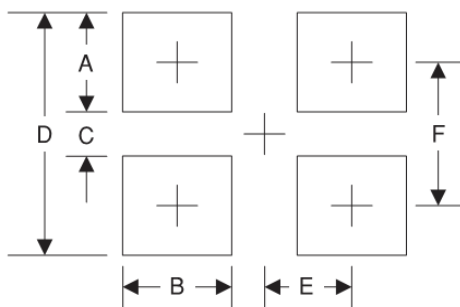

Symbol	Unit (mm)	Unit (inch)
A	1.5	0.059
B	0.9	0.035
C	4.22	0.166
D	7.22	0.284
E	2.05	0.081
F	5.72	0.225

MARKING DIAGRAM



P/N = Specific Device Code  
 YW = Date Code  
 F = Factory Code

## Notice

Specifications of the products displayed herein are subject to change without notice. TSC or anyone on its behalf, assumes no responsibility or liability for any errors or inaccuracies.

Information contained herein is intended to provide a product description only. No license, express or implied, to any intellectual property rights is granted by this document. Except as provided in TSC's terms and conditions of sale for such products, TSC assumes no liability whatsoever, and disclaims any express or implied warranty, relating to sale and/or use of TSC products including liability or warranties relating to fitness for a particular purpose, merchantability, or infringement of any patent, copyright, or other intellectual property right.

The products shown herein are not designed for use in medical, life-saving, or life-sustaining applications. Customers using or selling these products for use in such applications do so at their own risk and agree to fully indemnify TSC for any damages resulting from such improper use or sale.