

Bridge Rectifiers

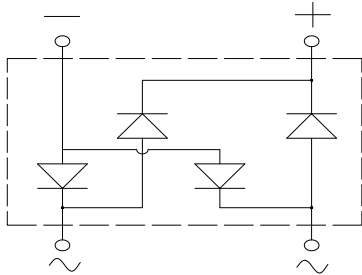
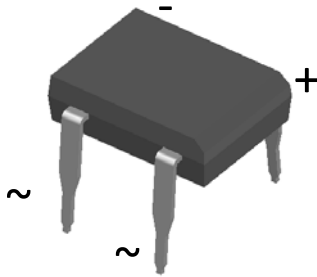

Features

- UL recognition, file #E313149
- High surge current capability
- Solder dip 275 °C max. 7 s, per JESD 22-B106

Typical Applications

General purpose use in AC/DC bridge full wave rectification for SMPS, lighting ballast, adapter, battery charger, home appliances, office equipment, and telecommunication applications.

Mechanical Data

- **Package:** DB
Molding compound meets UL 94 V-0 flammability rating, RoHS-compliant
- **Terminals:** Tin plated leads, solderable per J-STD-002 and JESD22-B102
- **Polarity:** As marked on body

■ Maximum Ratings (T_a=25°C Unless otherwise specified)

PARAMETER	SYMBOL	UNIT	DB201	DB202	DB203	DB204	DB205	DB206	DB207
Device marking code			DB201	DB202	DB203	DB204	DB205	DB206	DB207
Repetitive peak reverse voltage	V _{RRM}	V	50	100	200	400	600	800	1000
Average rectified output current @60Hz sine wave, R-load, T _a =40°C	I _o	A	2.0						
Surge(non-repetitive)forward current @60Hz half sine wave, 1 cycle, T _j =25°C	I _{FSM}	A	60						
Current squared time @1ms≤t≤8.3ms T _j =25°C, Rating of per diode	I ² t	A ² s	15						
Storage temperature	T _{stg}	°C	-55 ~+150						
Junction temperature	T _j	°C	-55 ~+150						

■ Electrical Characteristics (T_a=25°C Unless otherwise specified)

PARAMETER	SYMBOL	UNIT	TEST CONDITIONS	DB201	DB202	DB203	DB204	DB205	DB206	DB207
Maximum instantaneous forward voltage drop per diode	V _F	V	I _{FM} =1.0A	1.00						
Maximum DC reverse current at rated DC blocking voltage per diode	I _{RRM}	μA	V _{RM} =V _{RRM}	5						

■ Thermal Characteristics (T_a=25°C Unless otherwise specified)

PARAMETER	SYMBOL	UNIT	DB201	DB202	DB203	DB204	DB205	DB206	DB207
Thermal Resistance	R _{θJ-A} ⁽¹⁾	°C/W	68.0						
	R _{θJ-L}		15.0						

Note

(1)Thermal resistance from Between junction and ambient, On glass-epoxy substrate.



DB201 THRU DB207

Ordering Information (Example)

PREFERRED P/N	PACKING CODE	UNIT WEIGHT(g)	MINIIMUM PACKAGE(pcs)	INNER BOX QUANTITY(pcs)	OUTER CARTON QUANTITY(pcs)	DELIVERY MODE
DB201~DB207	B1	Approximate 0.39	50	2500	10000	Tube

Characteristics (Typical)

FIG1:Io-Ta Curve

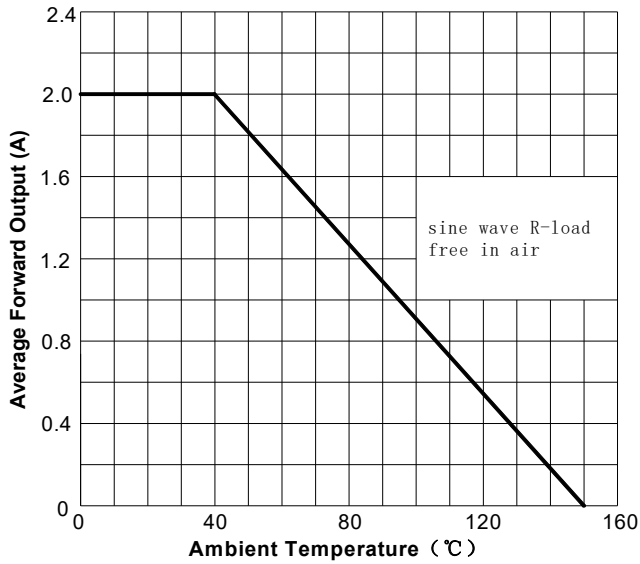

FIG2: Surge Forward Current Capability

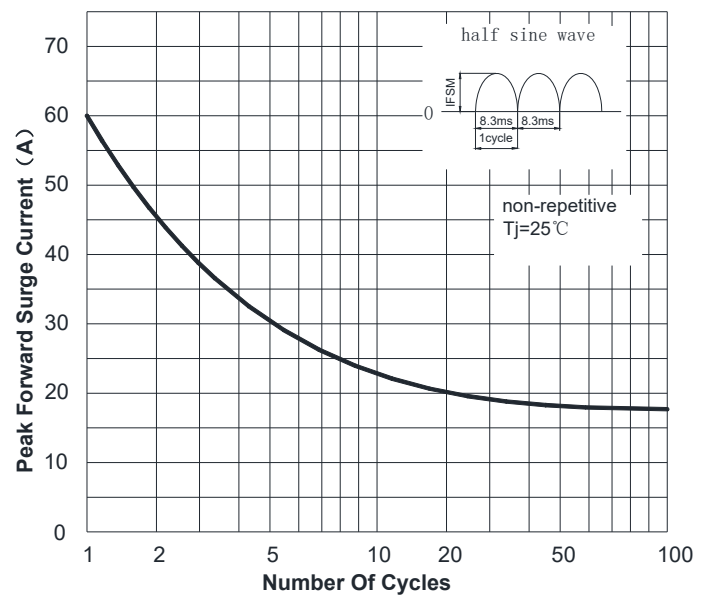

FIG3: Forward Voltage

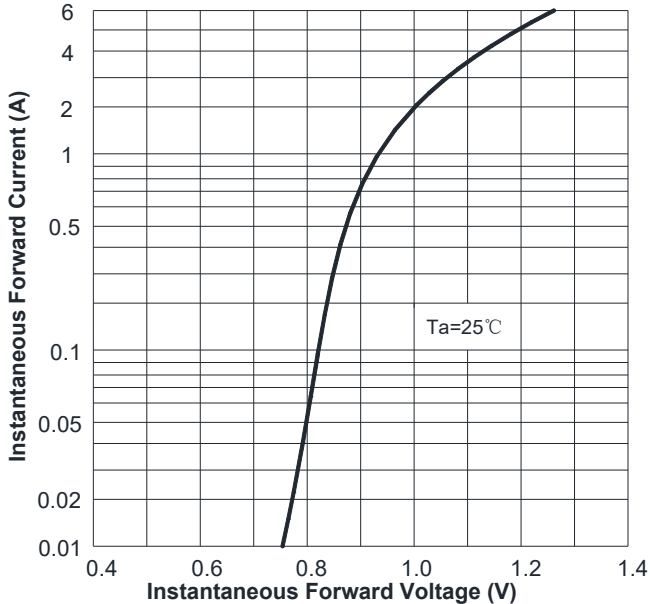
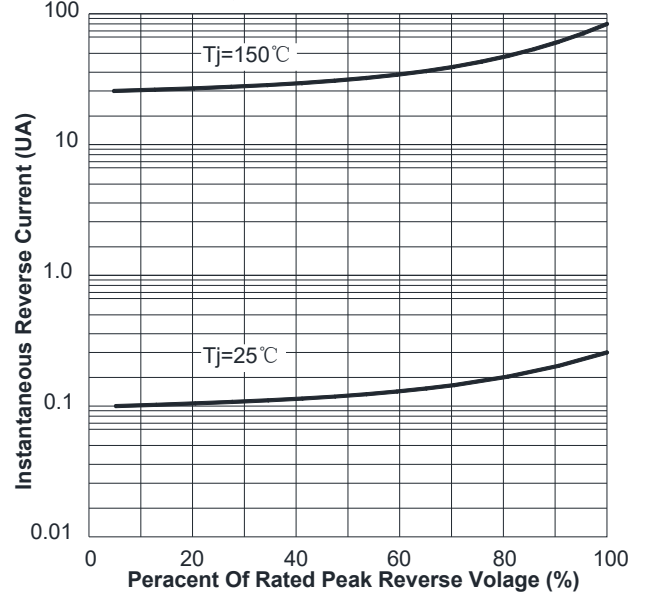

FIG4: Typical Reverse Characteristics





DB201 THRU DB207

■ Outline Dimensions

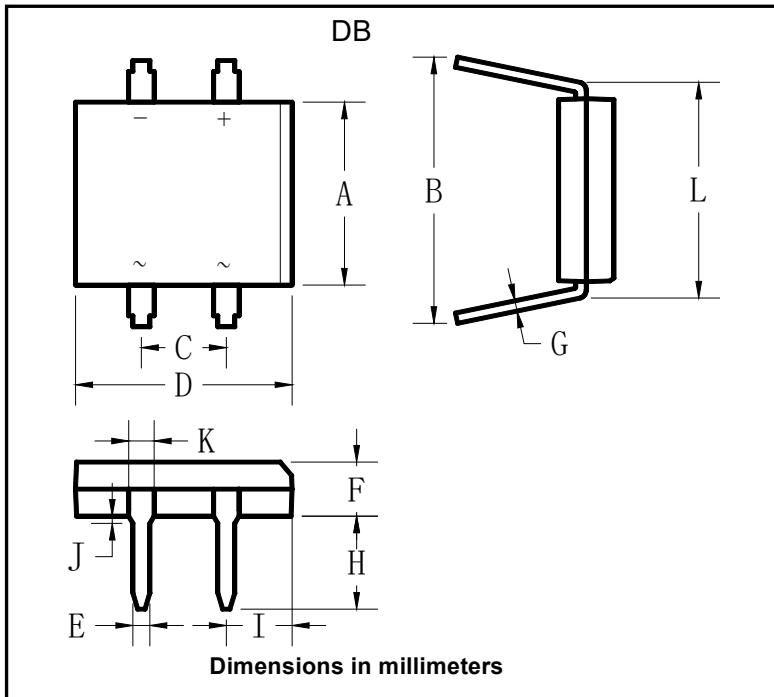

Dim	DB	
	Min	Max
A	6.20	6.50
B	7.60	8.90
C	5.00	5.20
D	8.13	8.51
E	0.46	0.58
F	2.80	3.30
G	0.22	0.33
H	3.81	4.69
I	1.39	1.90
J	1.27	2.03
K	0.89	1.14
L	7.24	8.00



Disclaimer

The information presented in this document is for reference only. Yangzhou Yangjie Electronic Technology Co., Ltd. reserves the right to make changes without notice for the specification of the products displayed herein to improve reliability, function or design or otherwise.

The product listed herein is designed to be used with ordinary electronic equipment or devices, and not designed to be used with equipment or devices which require high level of reliability and the malfunction of which would directly endanger human life (such as medical instruments, transportation equipment, aerospace machinery, nuclear-reactor controllers, fuel controllers and other safety devices), Yangjie or anyone on its behalf, assumes no responsibility or liability for any damages resulting from such improper use of sale.

This publication supersedes & replaces all information previously supplied. For additional information, please visit our website [http:// www.21yangjie.com](http://www.21yangjie.com) , or consult your nearest Yangjie's sales office for further assistance.