

REVISIONS

REV	ECO	DESCRIPTION	DATE	BY	APPR
A1	-	RELEASE DRAWING	30/AUG/21	IAN	TOMMY
A2	-	MODIFICATION TYPICAL WIRE RANGE	15/SEP/21	IAN	TOMMY

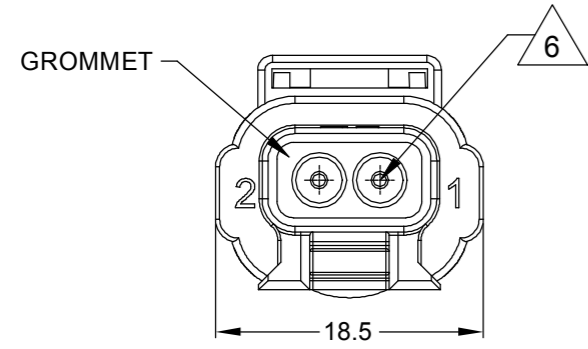
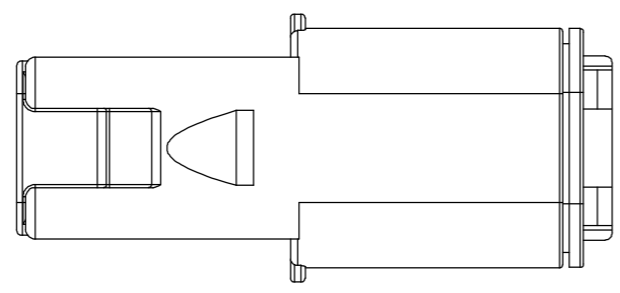
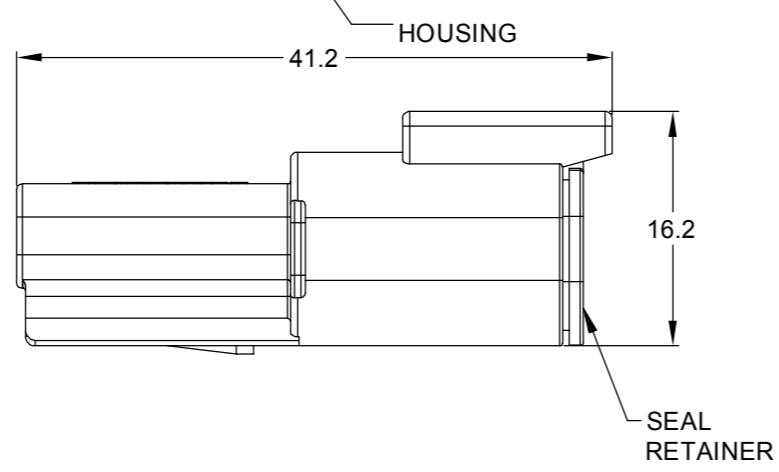
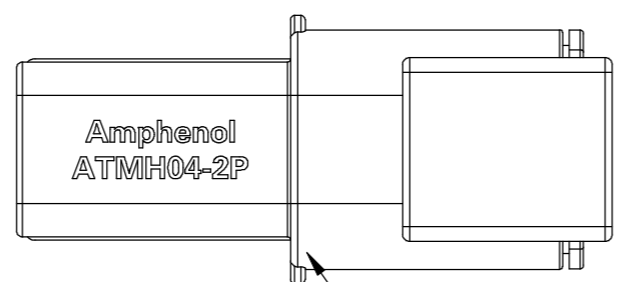
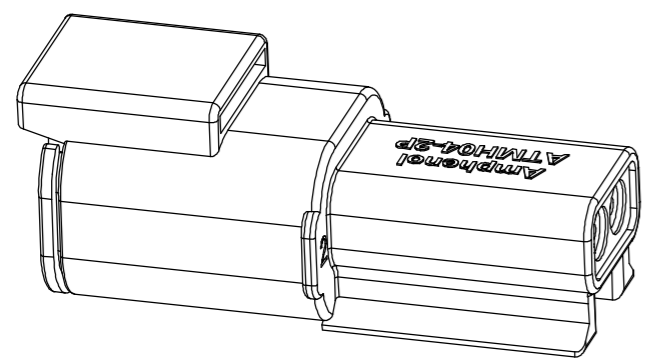

NOTES: UNLESS OTHERWISE SPECIFIED

- MATERIAL:  
HOUSING: THERMOPLASTIC, BLACK  
INTERFACE SEAL: SILICONE RUBBER, RED  
GROMMET: SILICONE RUBBER, RED  
SEAL RETAINER: THERMOPLASTIC, BLACK  
TERMINAL POSITION ASSURANCE LOCK: THERMOPLASTIC, SEE KEYS ARRANGEMENTS FOR COLOR
- MODIFICATIONS: N/A
- SPECIFICATIONS:  
3.1 CURRENT RATING: 7.5 AMPS  
3.2 OPERATING TEMPERATURE: -55°C TO +150°C  
3.3 DIELECTRIC WITHSTANDING VOLTAGE: LESS THAN 2 MILLIAMPS CURRENT LEAKAGE @ 1500 VOLTS AC.  
3.4 INSULATION RESISTANCE: 1000 MEGOHMS MIN @ 25°C.  
3.5 MOISTURE RESISTANCE:  
IP68(IM OF WATER FOR A PERIOD OF 24 HOURS, MATED CONDITION);  
IP69K(MATED CONDITION)  
3.6 MATING CYCLE DURABILITY: 100 CYCLES  
3.7 RoHS COMPLIANT

4. MATING PART: ATMH06-2SX (X = A,B,C,D KEYS)

5. ALL DIMENSIONS ARE FOR REFERENCE USE ONLY.

6 CONTACT SIZE AND REAR SEAL WIRE RANGE:

CONTACT SIZE	MIN. INSUL O.D.	MAX. INSUL O.D.	TYPICAL WIRE RANGE
20	1.35 mm (.053 in)	3.05 mm (.120 in)	16 - 22 AWG (1.5 - 0.35 mm <sup>2</sup> )

7 TERMINAL POSITION ASSURANCE (TPA) LOCK PRE-MOUNTED: AWMH-2PX (X = A,B,C,D KEYS)

KEYS ARRANGEMENTS

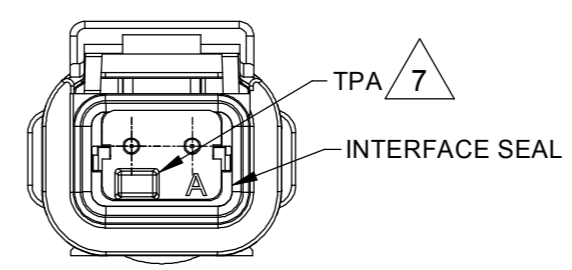

KEY-A CONFIGURATION  
ATMH04-2PA  
TPA COLOR: GRAY

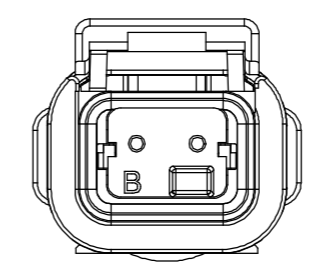

KEY-B CONFIGURATION  
ATMH04-2PB  
TPA COLOR: BLACK

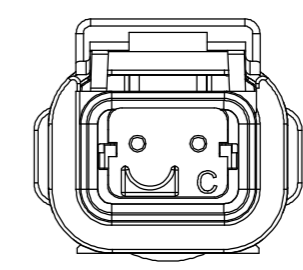

KEY-C CONFIGURATION  
ATMH04-2PC  
TPA COLOR: GREEN

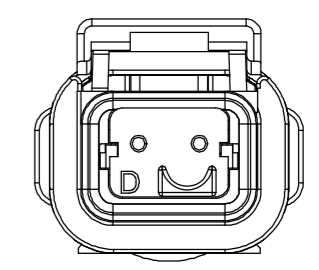

KEY-D CONFIGURATION  
ATMH04-2PD  
TPA COLOR: BROWN



QUANTITY	PART NUMBER	DESCRIPTION	ITEM
	ATMH04-2PX(SEE KEYS ARRANGEMENTS)	REF:DTMH04-2PA, DTMH04-2PB, DTMH04-2PC, DTMH04-2PD	

SIGNATURES		DATE	<h1>Amphenol</h1> <p>Sine Systems - www.amphenol-sine.com 44724 Morley Drive Clinton Township, MI 48036</p> <p>2 POS, RECEPTACLE, PIN, ATMH SERIES, KEYED, BLACK COLOR</p>
DRAWN:	IAN	15/SEP/21	
CHECKED:	SULLEN	15/SEP/21	
ENGINEER:			
APPROVAL:	TOMMY	16/SEP/21	
MATERIAL SPECIFICATIONS:			
PROCESS SPECIFICATIONS:			
NEXT ASSY:			
<small>UNLESS OTHERWISE SPECIFIED</small> 1) All dimensions are in metric(mm). 2) Tolerances are as follows: 1 PL DEC ±0.30 2 PL DEC ±0.15 3 PL DEC ±0.08 3) Note reference = $\triangle$			<small>THIS DRAWING IS SUPPLIED FOR INFORMATION ONLY. DESIGN FEATURES, SPECIFICATIONS AND PERFORMANCE DATA SHOWN HEREON ARE THE PROPERTY OF THE AMPHENOL CORPORATION. NO RIGHTS OF REPRODUCTION ARE IMPLIED. ALL DIMENSIONS ARE SUBJECT TO NORMAL MANUFACTURING VARIATIONS.</small>
SIZE	TYPE	DWG NO.	REVISION
B	C-	ATMH04-2PX	A2
SCALE:	NONE	SHEET 1 OF 1	





TITLE: 2 POS, RECEPTACLE, PIN, ATMH SERIES, KEYED, BLACK COLOR  
DWG NO.: ATMH04-2PX  
REV: A2  
SH: 1  
OF: 1

# ATM Series™ - Contact Size 20 Options



Machined Contacts, Sockets & Pins				
Part Number	Description	Size	AWG	Type
AT60-010-2031	Male Contact - Pin, Gold-plated	20	16-18	Machined
AT62-005-20141	Female Contact - Socket, Gold-plated	20	16-18	Machined
AT60-010-20141	Male Contact - Pin, Nickel-plated	20	16-18	Machined
AT62-005-2031	Female Contact - Socket, Nickel-plated	20	16-18	Machined
AT60-202-2031	Male Contact - Pin, Gold-plated	20	20-22	Machined
AT62-201-2031	Female Contact - Socket, Gold-plated	20	20-22	Machined
AT60-202-20141	Male Contact - Pin, Nickel-plated	20	20-22	Machined
AT62-201-20141	Female Contact - Socket, Nickel-plated	20	20-22	Machined

Tooling - Machined Contacts		
Part	Part Number	Description
	CA-5D12	Universal Hand Crimp Tool, Size 12/16/20 (Machined contacts only)
	CA-5E12	Pneumatic Crimp Tool, Size 12/16/20 (Machined contacts only)

Contact Removal Tools		
Part	Part Number	Description
	ATRT-100	Used for removal of contacts for A Series™ products
	AT11-240-2005	Contact Removal Tool, Plastic, Size 20

Sealing Plugs		
Part	Part Number	Description
	AT13-204-2005	Sealing Plug, Size 20, White
	AT13-204-2005-SR	Sealing Plug, Size 20, SR01 Series, Black
	ATM13-217-2005	Locking Sealing Plug, Size 20, Grey
	ATM13-217-2005-SR	Locking Sealing Plug, Size 20, SR01 Series, Blue

Stamped & Formed Contacts, Sockets & Pins				
Part Number	Description	Size	AWG	Type
AT60-20-0144	Male Contact - Pin, Gold-plated	20	16-22	Stamped & Formed
AT62-20-0144	Female Contact - Socket, Gold-plated	20	16-22	Stamped & Formed
AT60-20-0244	Male Contact - Socket, Gold-plated	20	16-22	Stamped & Formed
AT62-20-0244	Female Contact - Socket, Gold-plated	20	16-22	Stamped & Formed
AT60-20-0122	Male Contact - Pin, Nickel-plated	20	16-22	Stamped & Formed
AT62-20-0122	Female Contact - Socket, Nickel-plated	20	16-22	Stamped & Formed
AT60-20-0222	Male Contact - Socket, Nickel-plated	20	16-22	Stamped & Formed
AT62-20-0222	Female Contact - Socket, Nickel-plated	20	16-22	Stamped & Formed
AT60-20-0277	Male Contact - Socket, Tin-plated	20	16-22	Stamped & Formed
AT62-20-0277	Female Contact - Socket, Tin-plated	20	16-22	Stamped & Formed
AT60-20-0422	Male Contact - Socket, Nickel-plated	20	20-22	Stamped & Formed
AT62-20-0444	Female Contact - Socket, Gold-plated	20	20-22	Stamped & Formed

Tooling - Stamped & Formed Contacts		
Part	Part Number	Description
	MFx-3974	Crimp Die - Size 20 (S&F contacts only)
	MFx-3976	Crimp Die - Size 20 (S&F contacts only) 20-22AWG -04XX Series
	MFx-3978	Crimp Die - Size 20 (S&F contacts only) 20-22AWG -02XX Series
	ATT-20-00	Hand Crimp Tool - Size 20, 20AWG (S&F contacts only)