

REVISIONS				
REV.	DESCRIPTION OF CHANGE	DATE	BY	APPROVED
0	INITIAL LAIRD RELEASE	6/28/2021	FJG	FJG

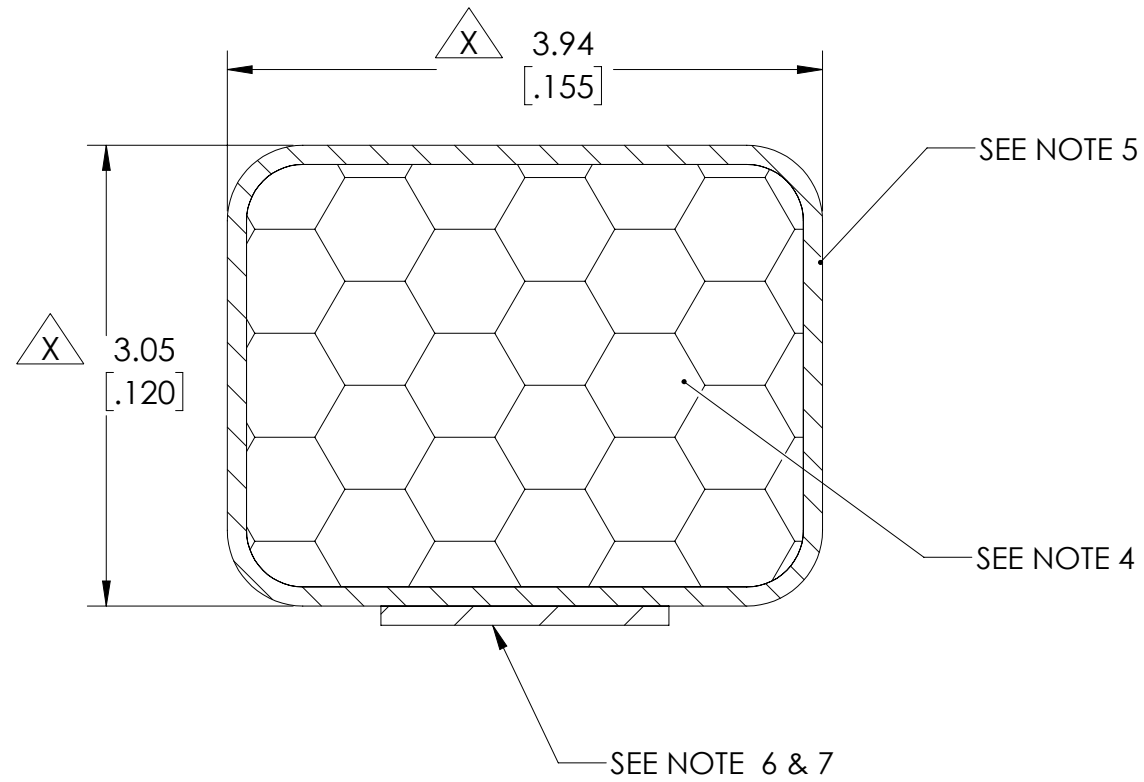

- NOTES:**
1. CRITICAL DIMENSIONS ARE DESIGNATED BY $\triangle X$
 2. REFERENCE DIMENSIONS WILL BE SHOWN IN PARENTHESES (DIM)
 3. FABRIC SEAM LOCATION MAY VARY
 4. FOAM: POLYURETHANE
 5. FABRIC: NICKEL PET-TAF FR EcoGreen
 6. TAPE: 1.91mm WIDE HI-TEMP ADHESIVE
 7. LINER: NO EXTENDED RELEASE LINER
 8. CARRIER: NO CARRIER

- ROHS -

THIS PRODUCT IS FULLY COMPLIANT TO LT-GES-001 WHICH MEETS OR EXCEEDS COMPLIANCE REQUIREMENTS OF EUROPEAN DIRECTIVE 2011/65/EU 'RESTRICTION OF USE OF HAZARDOUS SUBSTANCES'

CAD MAINTAINED DRAWING
REV. CONTROLLED DOCUMENT
MANUAL CHANGES UNAUTHORIZED
PRINTED COPIES OF THIS DOCUMENT
ARE CONSIDERED UNCONTROLLED.

3D MODEL REQUIRED FOR COMPLETE DOCUMENTATION

BLOCK TOLERANCES APPLY TO METRIC UNITS ONLY. DUAL DIMENSIONS IF SHOWN ARE FOR REFERENCE ONLY AND ARE DISPLAYED IN 3 PLACES FOR CONVERSION PURPOSES ONLY

INFORMATION CONTAINED IN THIS DOCUMENT IS CONFIDENTIAL AND PROPRIETARY TO LAIRD. IT MAY NOT BE DISCLOSED TO ANYONE WITHOUT WRITTEN AUTHORIZATION FROM LAIRD TECHNOLOGIES.

UNITS: MM [INCH]

TOLERANCES:
X.XX = ± 0.5

LENGTHS:
1 - 152 = ± 0.8
152 - 279 = ± 1.3
279 - 1219 = ± 2.5
1219 - 1778 = ± 4.8
1778 - 2438 = ± 6.4

ANGULAR:
X.X° = ± 1.0°

Laird™

3RD ANGLE PROJECTION

DESIGNED IN SOLIDWORKS

SCALE: 20:1 SHEET 1 OF 1

MATERIAL: X1R (SEE NOTES)

THICKNESS: SEE DRAWING

FINISH: N/A

SIZE: B

PART DESCRIPTION: SHIELDING GASKET

CUSTOMER: N/A

PROGRAM NAME: N/A

CUSTOMER PART NUMBER: N/A

LAIRD PART FAMILY/GROUP: FABRIC OVER FOAM

LAIRD PART NUMBER: 4209PAX1R

MODEL BY: FRANK GIBILTERRA DATE: 6/28/2021

APPROVED BY: FRANK GIBILTERRA DATE: 6/28/2021

LAIRD STD PART REF: N/A

REV: 0