

Mounting Option

08-#4-40 Unified Threaded Inserts

Contact Detail

520-P.C. Tail .025x.013(0.64x0.33) - Tail LG.=.125(3.18)

.100 [2.54] Contact Spacing x .140 [3.56] Row Spacing

THIS IS A C.A.D. GENERATED DRAWING
DO NOT MAKE MANUAL REVISIONS TO MASTER.



ISSUE NUMBER

ORIGINAL

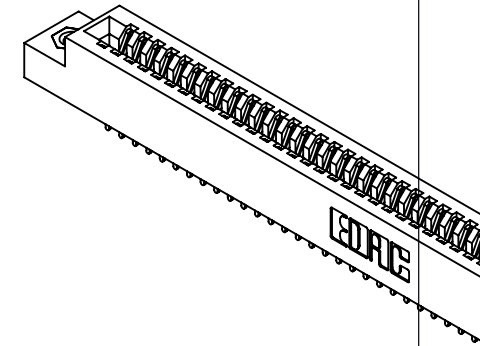
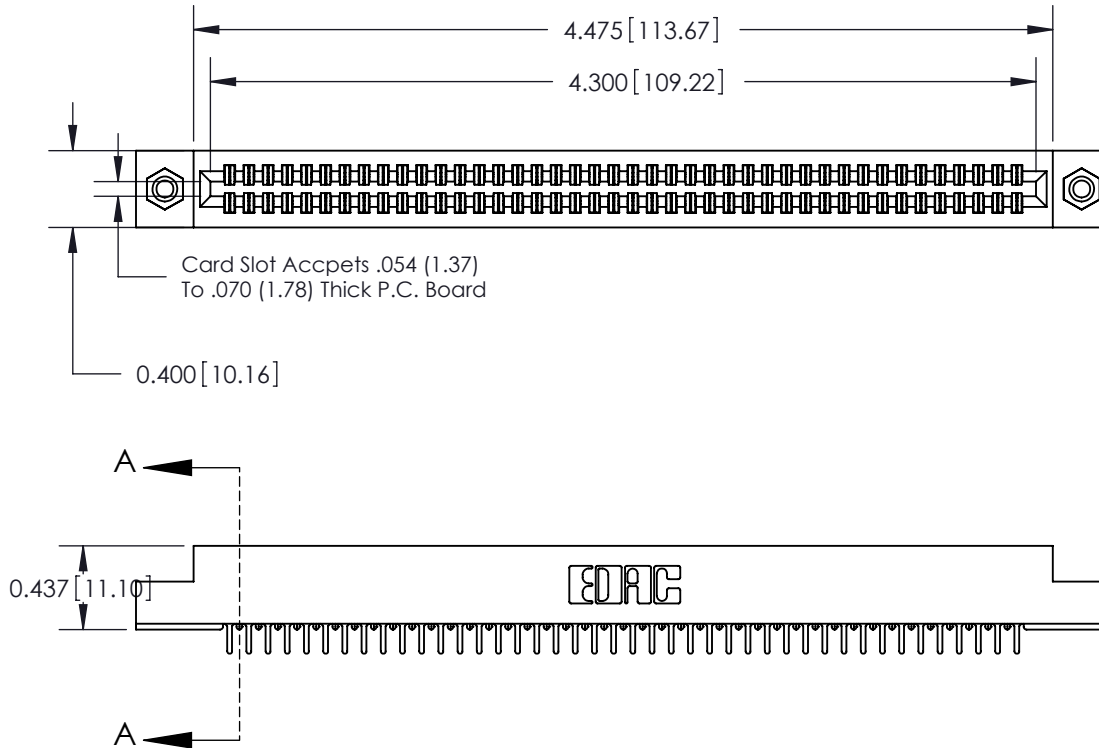

See Accompanying Pages for:

- Contact Bend Details
- Mounting Options
- Features and Specifications

341/391 Series Card Edge Connector

Part Number: 391-084-520-208



EDAC INC
TORONTO, ONTARIO
CANADA

YOUR CONNECTION TO QUALITY & SERVICE

THESE DRAWINGS AND SPECIFICATIONS
ARE THE PROPERTY OF EDAC INC. AND
SHALL NOT BE REPRODUCED, OR COPIED
OR USED AS THE BASIS FOR THE
MANUFACTURE OR SALE OF APPARATUS
WITHOUT WRITTEN PERMISSION.

ACAD REFERENCE NO. 341 ENG MASTER

DRAWN: J.LEE DATE: SEPT. 03/09

CHECKED: DATE:

SCALE: NTS SHEET 1 OF 3

DRAWING NUMBER ISSUE

341 Assembly

1



Bend Detail



555 Contact Code



556 Contact Code



560 Contact Code

Mounting Options



341/391 Series Card Edge Connector Bend Detail and Mounting Options



EDAC INC
TORONTO, ONTARIO
CANADA

YOUR CONNECTION TO QUALITY & SERVICE

THESE DRAWINGS AND SPECIFICATIONS ARE THE PROPERTY OF EDAC INC. AND SHALL NOT BE REPRODUCED, OR COPIED OR USED AS THE BASIS FOR THE MANUFACTURE OR SALE OF APPARATUS WITHOUT WRITTEN PERMISSION.

ACAD REFERENCE NO. 341 ENG MASTER

DRAWN: J.LEE DATE: SEPT. 03/09

CHECKED: DATE:

SCALE: NTS SHEET 2 OF 3

DRAWING NUMBER ISSUE

341 Assembly

1



Features

- UL Recognized
- .100 (2.54) Contact Spacing x .140 (3.56) Row Spacing
- Accepts .062 (1.57) Nominal Thickness P.C. Board
- Low Profile Insulator Body .437 (12.01)
- Contact Termination Options include P.C. Tail, Wire Hole, and Extender Board Bends
- Single or Dual Row Configurations
- Variety of Mounting Options
- Accepts Between Contact and In-Contact Polarizing Keys

Specifications

- Insulator Material: Thermoplastic Polyester, UL 94V-0
- Contact Material: Copper, Nickel, Tin Alloy CA-725
- Contact Plating: Gold on the Mating Area, Tin on the Contact Tails, Nickel Underplate
- Current Rating: 3 Amperes Continuous
- Contact Resistance: 10 Milliohms Maximum
- Dielectric Withstanding Voltage: 1200 V AC rms at Sea Level Between Adjacent Contacts
- Insulation Resistance: 5000 Megohms Minimum
- Operating Temperature: -65 to +105 Degrees C
- Insertion Force: 16 oz (4.45 N) Maximum per Contact Pair when Tested with a .070 (1.78) Thick Gauge
- Withdrawal Force: 1 oz (0.28 N) Minimum per Contact Pair when Tested with a .054 (1.37) Thick Gauge

341/391 Series Card Edge Connector Features and Specifications		ACAD REFERENCE NO. 341 ENG MASTER	
		DRAWN: J.LEE	DATE: SEPT. 03/09
 EDAC INC TORONTO, ONTARIO CANADA YOUR CONNECTION TO QUALITY & SERVICE		CHECKED:	DATE:
		SCALE: NTS	SHEET 3 OF 3
DRAWING NUMBER 341 Assembly		ISSUE 1	

THESE DRAWINGS AND SPECIFICATIONS ARE THE PROPERTY OF EDAC INC. AND SHALL NOT BE REPRODUCED, OR COPIED OR USED AS THE BASIS FOR THE MANUFACTURE OR SALE OF APPARATUS WITHOUT WRITTEN PERMISSION.