

PC 100/75 HG



Sample image

Order symbol: PC 100/75 HG

Product nbr: 6011302

UL Code: 6411302

UL Name: UL PC 100/75 HG

Description: Enclosure. PC

Remarks: Opaque cover

Including: Base with TPE gasket, screws for mounting plate/DIN-rail and cover with polyamide cover screws.

EAN: 6418074024404

El. number:

- Finland: 3422251
- Denmark: 821202292
- Sweden: 2535513

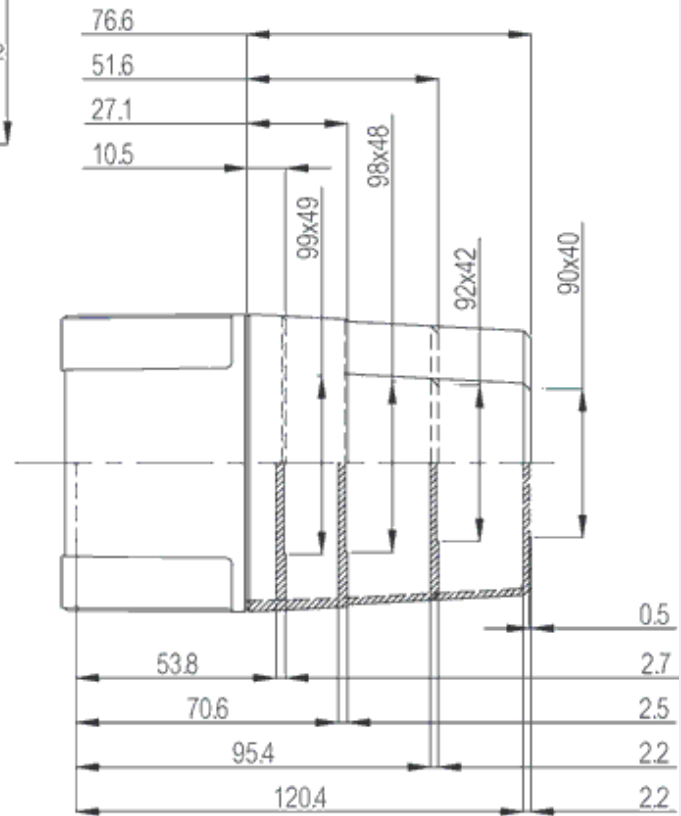
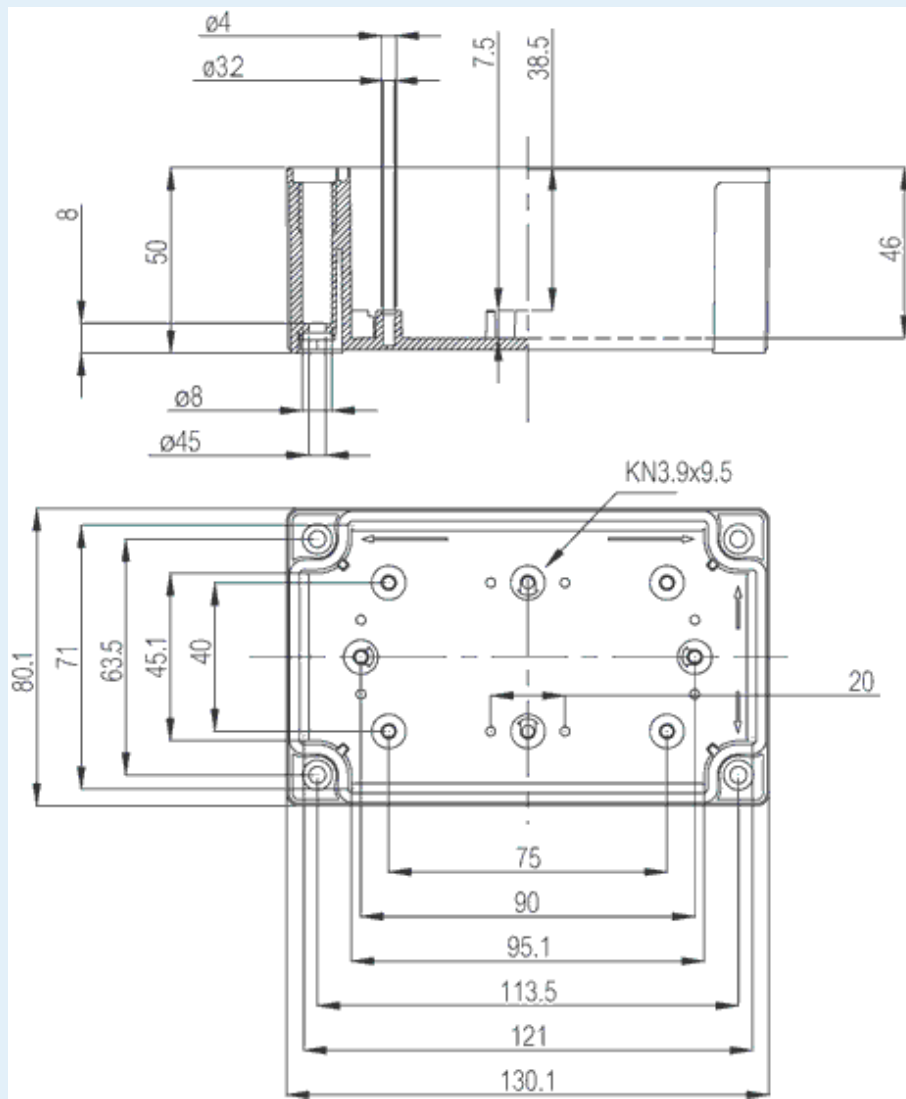

Dimensions:

	Height	Width	Depth
mm:	130	80	75
inch:	5.12	3.15	2.95

Materials:

Material:	Polycarbonate
Base colour:	RAL 7035 -light grey
Cover colour:	RAL 7035 -light grey
Gasket material:	Polyurethane

Temperatures:

Temperature °C (short term)::	-40 ... 120
Temperature °C (continuous):	-40 ... 80
Temperature °F (short term):	-40 ... 250
Temperature °F (continuous):	-40 ... 175

Accessories:

MIV 10	DIN-35 Mounting rail. for enclosures: (100 x 35 x 1)
MIV 5	DIN-35 Mounting rail. for enclosures: (50 x 35 x 1)
HFP 130	Front panel hinge series for FP A 100-125
MIN 5	DIN-15 Mounting rail. for enclosures: (50 x 15 x 1)
MIV 100	Back Panel (Galvanized steel). for enclosures: (98 x 48 x 1)
MIN 10	DIN-15 Mounting rail. for enclosures: (100 x 15 x 1)
FP 22046	Mounting foot kit (4 pcs)
FP A 100/130	Front panel (Aluminum). for enclosures: (120 x 62 x 1)

Rating:

Ingress protection (EN 60529):	IP66; IP67;
Impact Resistance (EN 62262):	IK08;
Electrical insulation:	Totally insulated
Halogen free (DIN/VDE 0472, Part 815):	1
UV resistance:	UL 508

Flammability Rating: UL 746C 5"

Glow Wire Test (IEC 695-2-1) °C: 960 °C

NEMA Class

Certificates:

Certificate FI 40847