

QT-Brightek Chip LED Series

SMD 1205 LED

Part No.: QBLP655R series

Table of Contents:

Introduction	3
Electrical / Optical Characteristic (Ta=25 °C)	4
Absolute Maximum Rating	4
Chromaticity Coordinates for White	7
Characteristic Curves.....	8
Solder Profile & Footprint.....	10
Packing	11
Labeling	12
Ordering Information	12
Revision History	13
Disclaimer	13

Introduction

Feature:

- Water clear lens (R/AG/Y/O/IG/IB)
- Package in tape and reel
- Ultra bright 1205 package
- InGaN technology for IB/IG/IW
- AlInGaP technology for R/AG/ Y/O
- Viewing angle: 140 degrees
- Reverse Mountable

Description:

These ultra-bright 655R LEDs have a height profile of 1.10mm. With a combination of high brightness output and small footprint, these LEDs are ideal for keypad backlighting and status indication.

Application:

- Status indication
- Back lighting application

Certification & Compliance:

- TS16949
- ISO9001
- RoHS Compliant



Dimension:

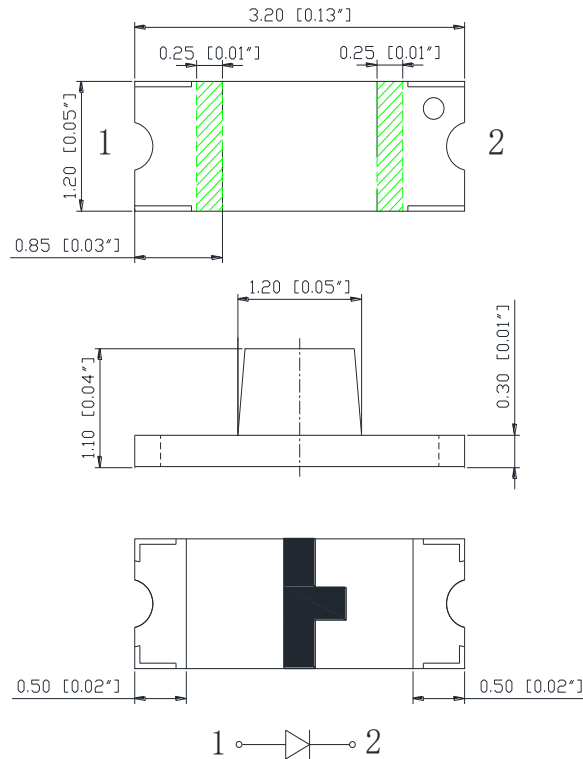

Units: mm / tolerance = +/-0.1mm

Electrical / Optical Characteristic (Ta=25 °C)

Product	Color	I _F (mA)	V _F (V)		λ _D (nm)			I _V (mcd)	
			Typ.	Max.	Min.	Typ.	Max.	Min.	Typ.
QBLP655R-R	Red	20	2.0	2.4	615	625	630	63	100
QBLP655R-Y	Yellow	20	2.0	2.5	585	590	595	40	65
QBLP655R-AG	Yellow Green	20	2.0	2.5	565	570	576	16	25
QBLP655R-O	Orange	20	2.0	2.5	600	605	610	63	100
QBLP655R-IG	True Green	20	3.1	3.7	515	520	525	200	525
QBLP655R-IB	Blue	20	3.1	3.7	465	470	475	32	60
QBLP655R-IW	White	20	3.1	3.7	-	X=0.29 Y=0.28	-	100	180

Absolute Maximum Rating

Material	P _d (mW)	I _F (mA)	I _{FP} (mA)*	V _R (V)	T _{OP} (°C)	T _{ST} (°C)	T _{SOL} (°C)**
AllInGaP (R/AG/Y/O)	75	30	125	5	-40 ~ +85	-40 ~ +100	260
InGaN (IB/IG/IW)	120	30	125	5	-40 ~ +85	-40 ~ +100	260

*Duty 1/8 @ 1kHz

**IR Reflow for no more than 10 sec @ 260 °C

Forward Voltage V_F for AllInGaP @ I_F=20mA

Bin	Min.	Max.	Unit
□	1.7	2.5	V

Forward Voltage V_F for InGaN @ I_F=20mA

Bin	Min.	Max.	Unit
f	2.8	3.1	V
g	3.1	3.4	
h	3.4	3.7	

Luminous Intensity I_V @ $I_F=20mA$

Bin	Min.	Max.	Unit
B	16	20	mcd
C	20	25	
D	25	32	
E	32	40	
F	40	50	
G	50	63	
H	63	80	
I	80	100	
J	100	125	
K	125	160	
L	160	200	
M	200	250	
N	250	320	
O	320	400	
P	400	500	
Q	500	630	
R	630	800	
S	800	1000	

Dominant Wavelength λ_D for Blue @ $I_F=20mA$

Bin	Min.	Max.	Unit
G	465	467.5	nm
H	467.5	470	
I	470	472.5	
J	472.5	475	

Dominant Wavelength λ_D for True Green @ $I_F=20mA$

Bin	Min.	Max.	Unit
S	515	517.5	nm
T	517.5	520	
U	520	522.5	
V	522.5	525	

Dominant Wavelength λ_D for Red @ $I_F=20mA$

Bin	Min.	Max.	Unit
s	615	620	nm
t	620	625	
u	625	630	

Dominant Wavelength λ_D for Yellow Green @ $I_F=20mA$

Bin	Min.	Max.	Unit
h	565	568	nm
i	568	572	
j	572	576	

Dominant Wavelength λ_D for Yellow @ $I_F=20mA$

Bin	Min.	Max.	Unit
m	585	590	nm
n	590	595	

Dominant Wavelength λ_D for Orange @ $I_F=20mA$

Bin	Min.	Max.	Unit
p	600	605	nm
q	605	610	

Note:

Tolerance of measurement of forward voltage: $\pm 0.1V$ Tolerance of measurement of luminous intensity: $\pm 15\%$ Tolerance of measurement of dominant wavelength: $\pm 2nm$

Chromaticity Coordinates for White

Chromaticity Chart

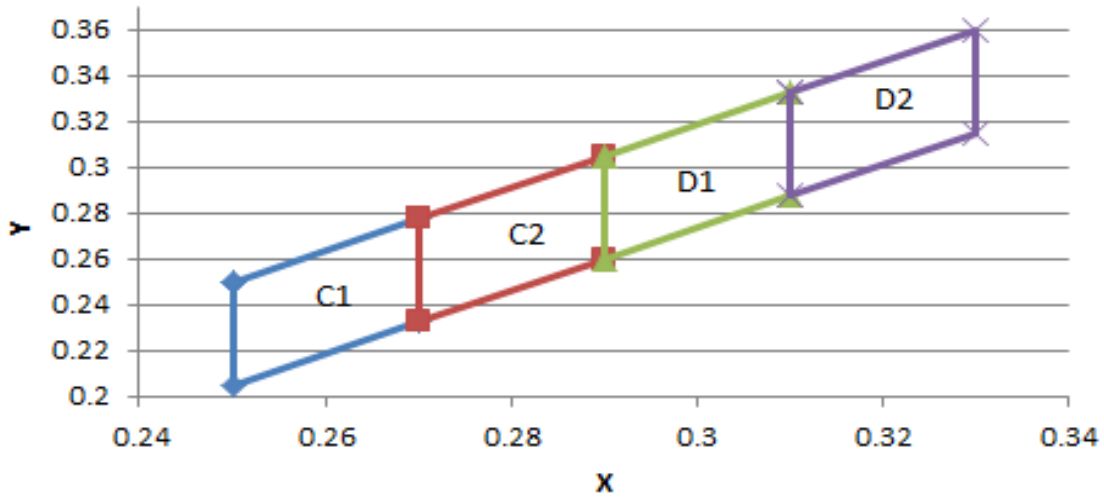

Rank	Chromaticity coordinates				
		X	0.2500	0.2700	0.2700
C1	Y	0.2500	0.2775	0.2325	0.2050
C2	X	0.2700	0.2900	0.2900	0.2700
	Y	0.2775	0.3050	0.2600	0.2325
D1	X	0.2900	0.3100	0.3100	0.2900
	Y	0.3050	0.3325	0.2875	0.2600
D2	X	0.3100	0.3300	0.3300	0.3100
	Y	0.3325	0.3600	0.3150	0.2875

Note:
Tolerance of measurement of color coordinates: ± 0.01

Characteristic Curves

AllnGaP (R/AG/Y/O)

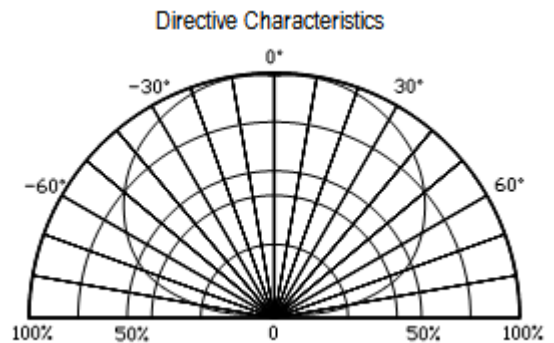
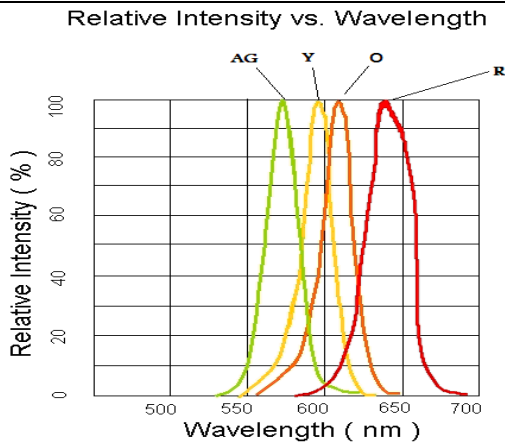
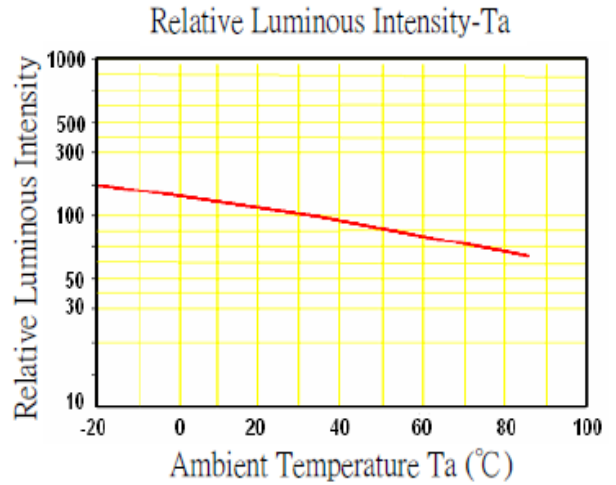
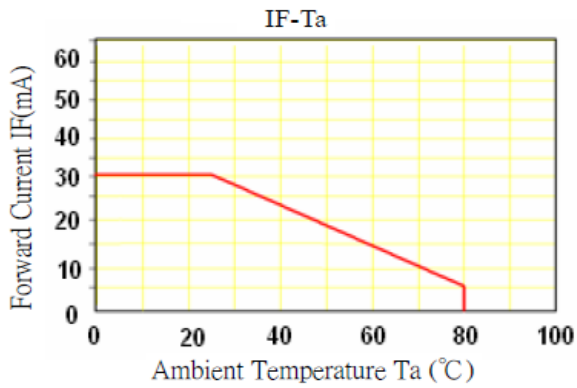
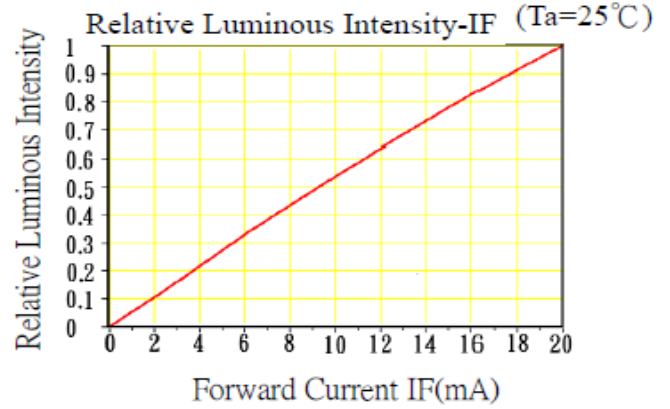
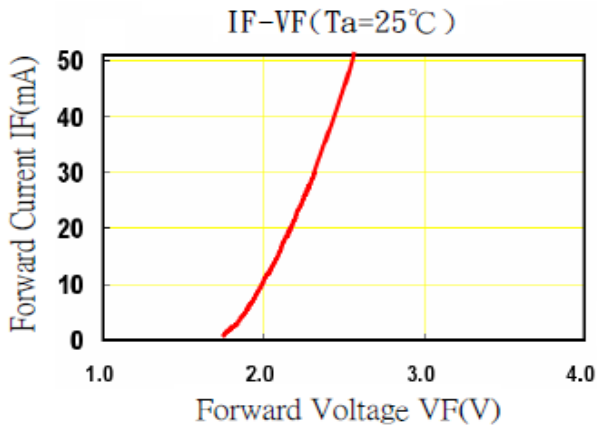

InGaN (IB/IG/IW)

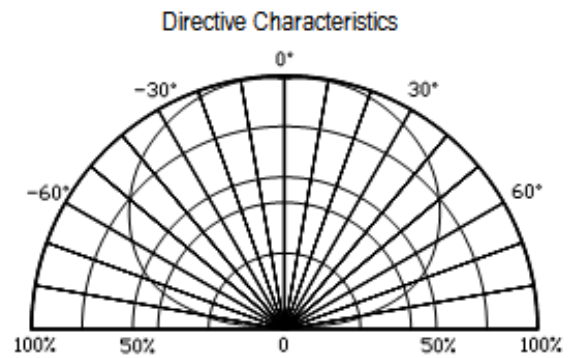
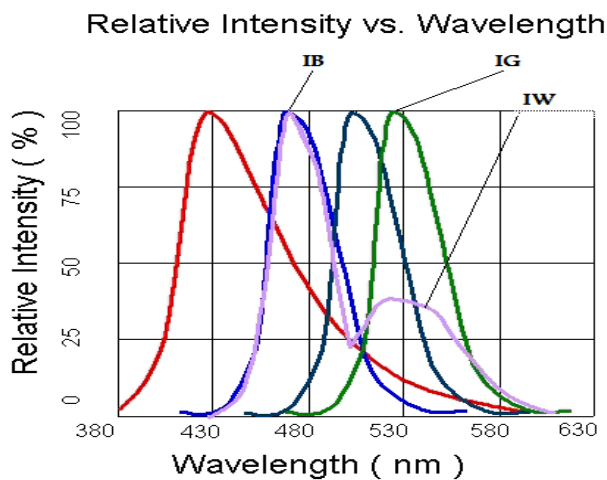
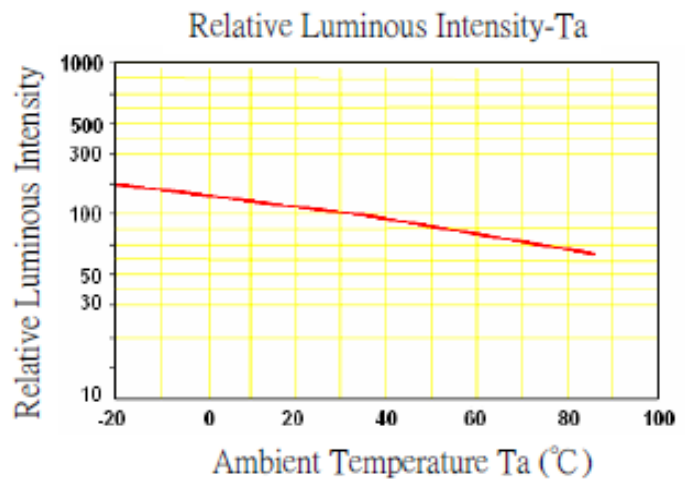
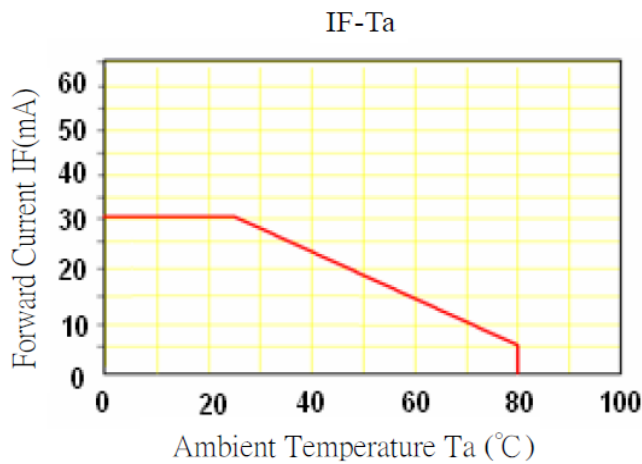
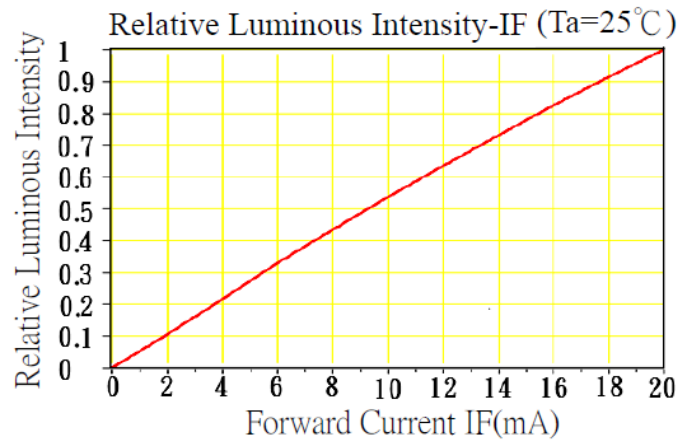
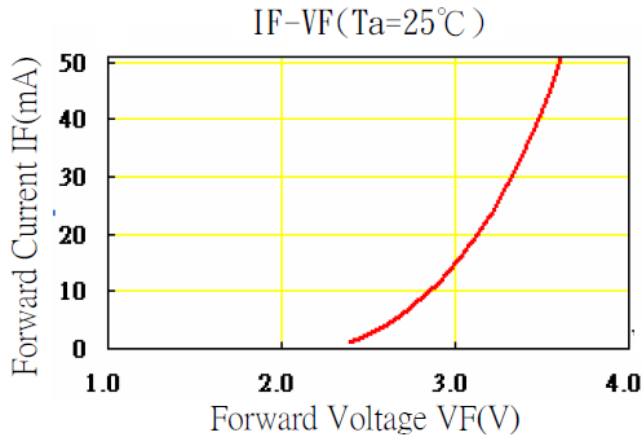

Solder Profile & Footprint

-The recommended reflow soldering profile is as follows (temperatures indicated are as measured on the surface of the LED resin):

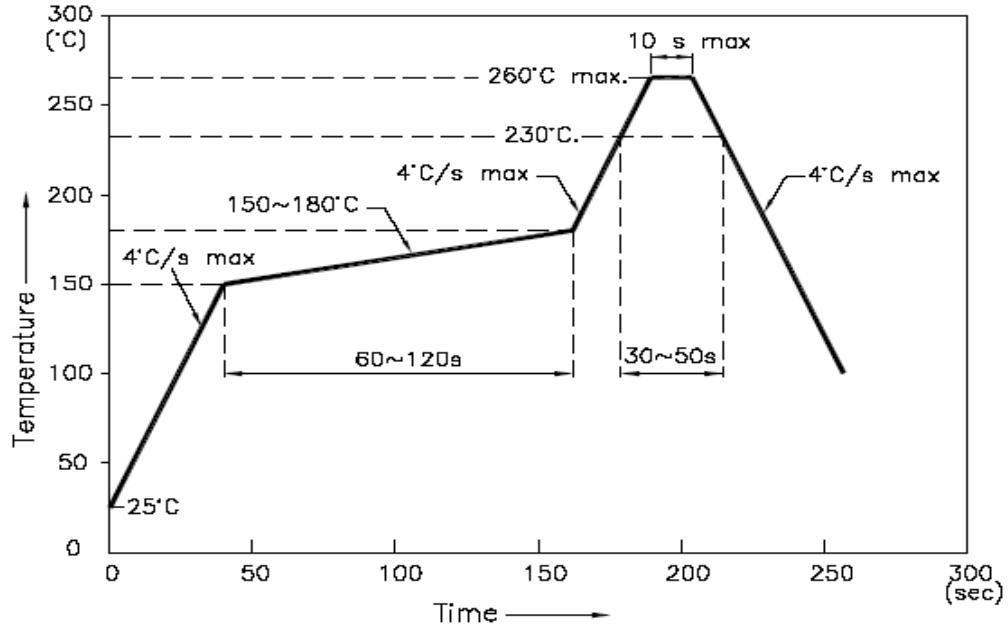

Recommended Pad Layout

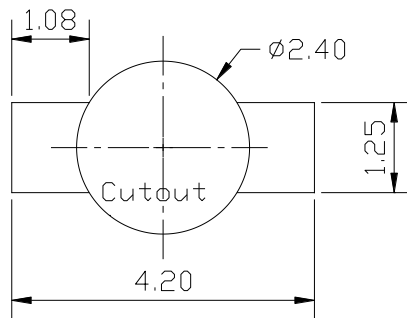

Units: mm

tolerance: +/- 0.1mm

Packing

Reel Dimension:

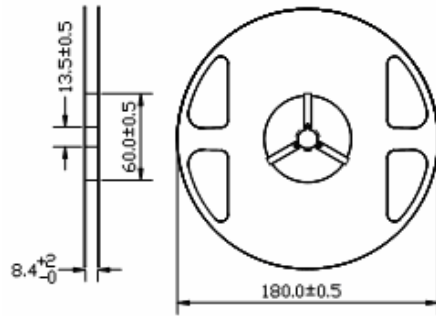

Unit: mm

Tape Dimension:

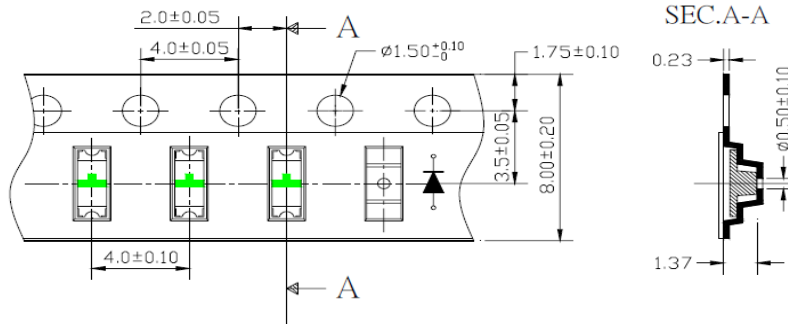

Unit: mm

Arrangement of Tape:

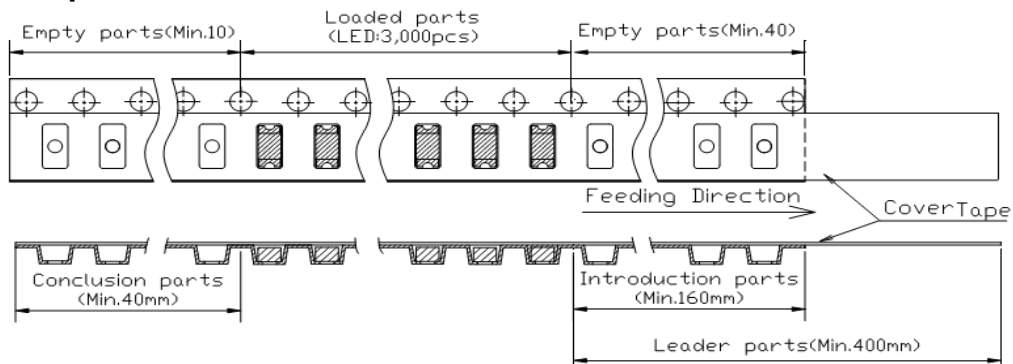

Packaging Specifications:

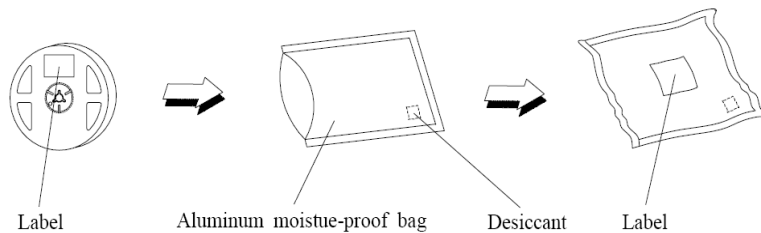

Product: QBLP655R_series	Date: November 21, 2016	Page 11 of 13
	Version# 2.0	

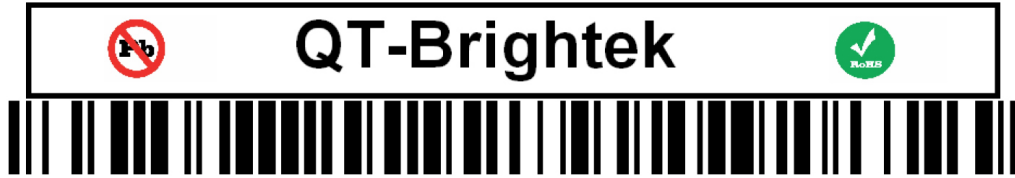
Labeling

Part No: _____

Customer P/N: _____

Item: _____

Q'ty: _____

Vf: _____

Iv: _____

WI: _____

Date: _____

Made in China**Ordering Information**

Part #	Orderable Part #	Spec Range	Quantity per reel
QBLP655R-R	QBLP655R-R	Iv=100mcd typ. @ 20mA / $\lambda_D=615-630\text{nm}$	3,000 units
QBLP655R-Y	QBLP655R-Y	Iv=65mcd typ. @ 20mA / $\lambda_D=585-595\text{nm}$	3,000 units
QBLP655R-AG	QBLP655R-AG	Iv=25mcd typ. @ 20mA / $\lambda_D=565-576\text{nm}$	3,000 units
QBLP655R-O	QBLP655R-O	Iv=100mcd typ. @ 20mA / $\lambda_D=600-610\text{nm}$	3,000 units
QBLP655R-IG	QBLP655R-IG	Iv=525mcd typ. @ 20mA / $\lambda_D=515-525\text{nm}$	3,000 units
QBLP655R-IB	QBLP655R-IB	Iv=60mcd typ. @ 20mA / $\lambda_D=465-475\text{nm}$	3,000 units
QBLP655R-IW	QBLP655R-IW	Iv=180mcd typ. @ 20mA / CCT Coordinate: (X=0.29, Y=0.28) typ.	3,000 units

Revision History

Description:	Revision #	Revision Date
New Release of QBLP655R_series	V1.0	01/13/2012
Update to new format	V1.1	06/05/2012
Minor format update / Update IG (True Green) brightness bin	V1.2	10/14/2015
Update dimension drawing to reflect the new PCB	V2.0	11/21/2016

Disclaimer

QT-BRIGHTTEK reserves the right to make changes without further notice to any products herein to improve reliability, function or design. QT-BRIGHTTEK does not assume any liability arising out of the application or use of any product or circuit described herein; neither does it convey any license under its patent rights, nor the rights of others.

Life Support Policy

QT-BRIGHTTEK's products are not authorized for use as critical components in life support devices or systems without the express written approval of QT-BRIGHTTEK. As used herein:

1. Life support devices or systems are devices or systems which, (a) are intended for surgical implant into the body, or (b) support or sustain life, and (c) whose failure to perform when properly used in accordance with instructions for use provided in the labeling, can be reasonably expected to result in a significant injury of the user.
2. A critical component in any component of a life support device or system whose failure to perform can be reasonably expected to cause the failure of the life support device or system, or to affect its safety or effectiveness.

Product: QBLP655R_series	Date: November 21, 2016	Page 13 of 13
	Version# 2.0	