

## SPECIFICATION

Part No. : **ALA.01.07.0095A**

Product Name : 1575MHz GPS-GALILEO Ceramic Active Loop Module

Features : 16dB One Stage  
GPS/GALILEO  
PCB Dims: 45\*10\*2.3mmmm  
RoHS Compliant

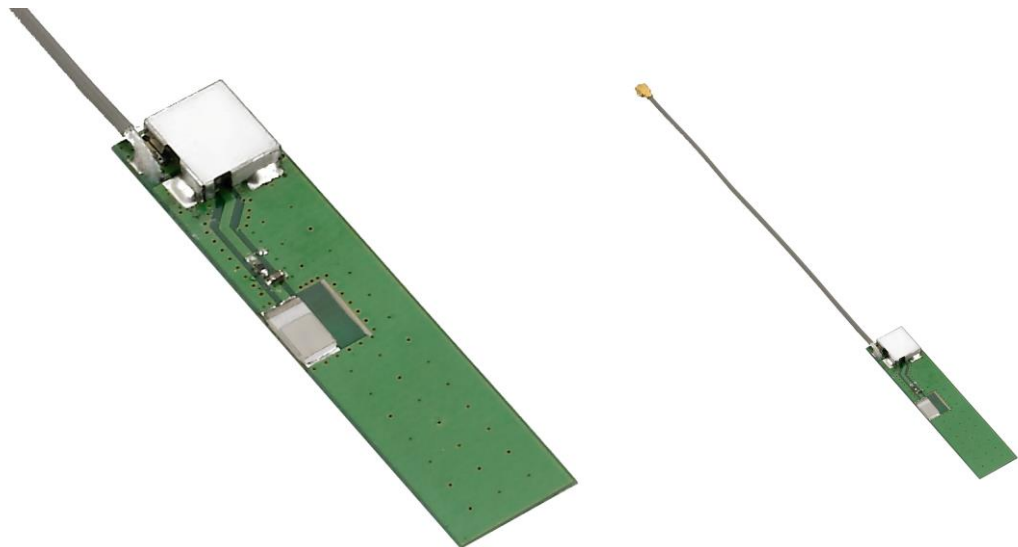

## 1. Introduction

The active loop antenna ALA.01 is best suited for applications where omni-directionality is important. The average gain is similar to an 18mm active patch antenna but in a much narrower profile, only 2.3mm at its highest point, allowing this antenna to be used perpendicular to the device main-board, or placed adjacent to the top or bottom of device main board. A one stage LNA combined with a SAW filter boosts the S/N (C/N) of the GPS/GALILEO system and helps to overcome some noise effects from today's crowded device boards that passive antennas cannot resolve.

The antenna can be placed in a plastic slot in the device housing. Alternatively, adhesive foam, hot-melt, or non-conductive screws could be used to mount the antenna. The core antenna design principle of loop current flow tends to "lock-out" a lot of surface noise from close circuitry from entering the antenna.

## 2. Specification

ELECTRICAL	
Frequency	1575.42 ± 1.023MHz
Bandwidth (10dB return loss)	70MHz typical
Peak Gain	Typ. 3.1dBi
Avg. Gain	-2.2dBI
Polarization	Linear
VSWR	2 max (depends on the special environment)
Dimension	5*3*0.5mm
Gain (with LNA)	16 ± 4dB @ 90°
Output Impedance	50Ω
Polarization	Linear
Input Voltage	Min. 2.6V, Typ. 3.0V, Max. 5.0V
LNA	
Frequency	1575.42 ± 1.023MHz
Gain	Typ. 16dB @ 3V Typ. 17.8dB @ 5V
Noise Figure	Typ. 1.3dB @ 3V
Filter (out of band attenuation)	Saw Filter (fo=1575.42MHz) 40dB typ. fo±50MHz 45dB min. fo±100Mhz
Output VSWR	< 2.0
Input Voltage	DC = 2.6~5.0V
Current	DC = 13mA at 3.0V

MECHANICAL	
RF Cable	95±5mm 1.13 Coaxial Cable
Connector	IPEX MHF(U.FL)
Dimensions	45*10*2.3mm
Weight	1.35±0.5g (typical)
ENVIRONMENTAL	
Operation Temperature	-40°C to + 85°C
Storage Temperature	-40°C to + 90°C
Humidity	10 to 95%

### 3. Performance Measurement

#### 3.1. Block Diagram

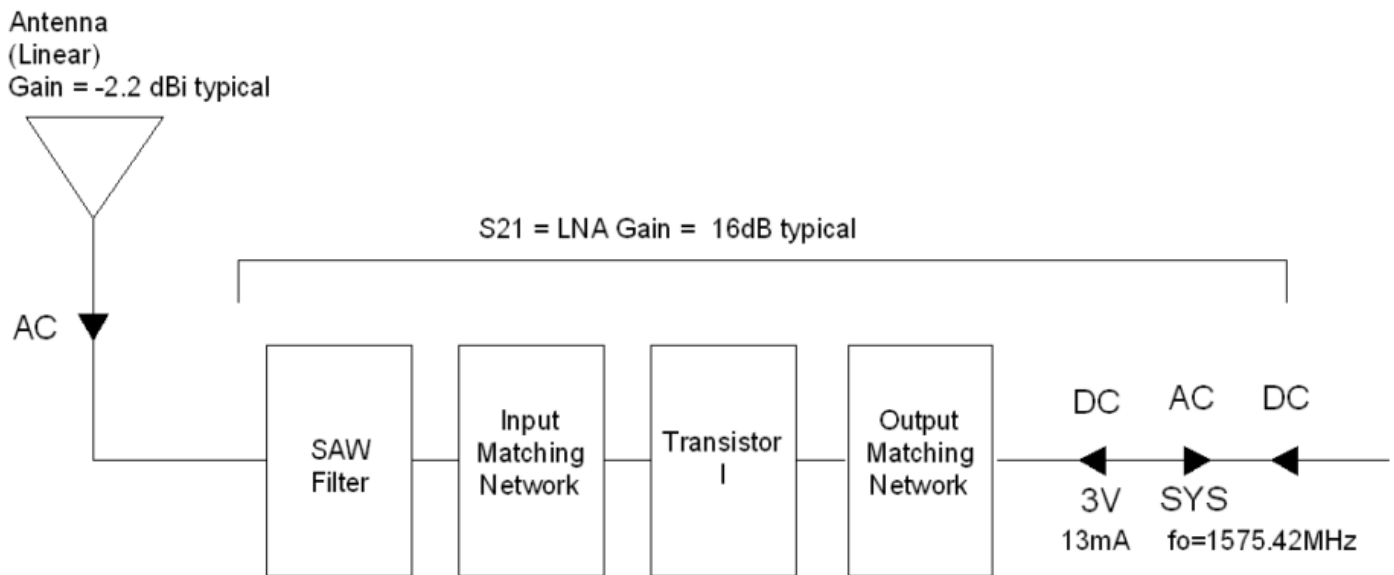

The structure of GPS antenna module

## 4. Measurement Method

### 4.1. Chip

#### a) Reflection Co-efficient Measurement

- a. Equipment: Network Analyzer (Agilent E5071A)(Fig.1)
- b. Item  $S_{11}$  Log Chart(Return Loss)  $S_{11}$  Smith Chart (impedance)



Figure 1. Network Analyzer

#### a) Pattern Measurement

- a. Equipment: Anechoic Chamber (Fig. 2), Network Analyzer (Agilent E8753ES)
- b. Item: Gain Pattern, Axial ratio

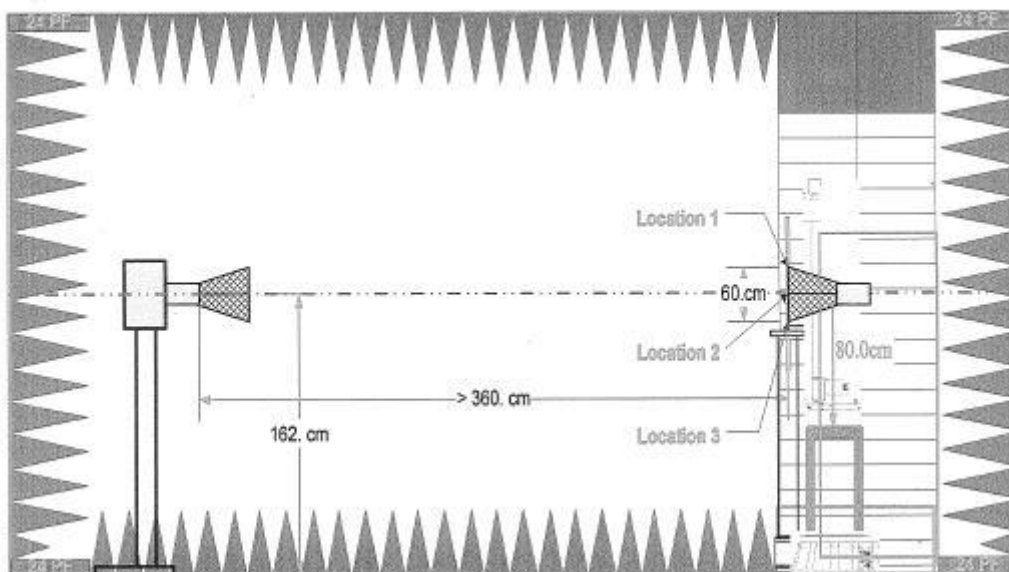

Figure 2. Quiet Room

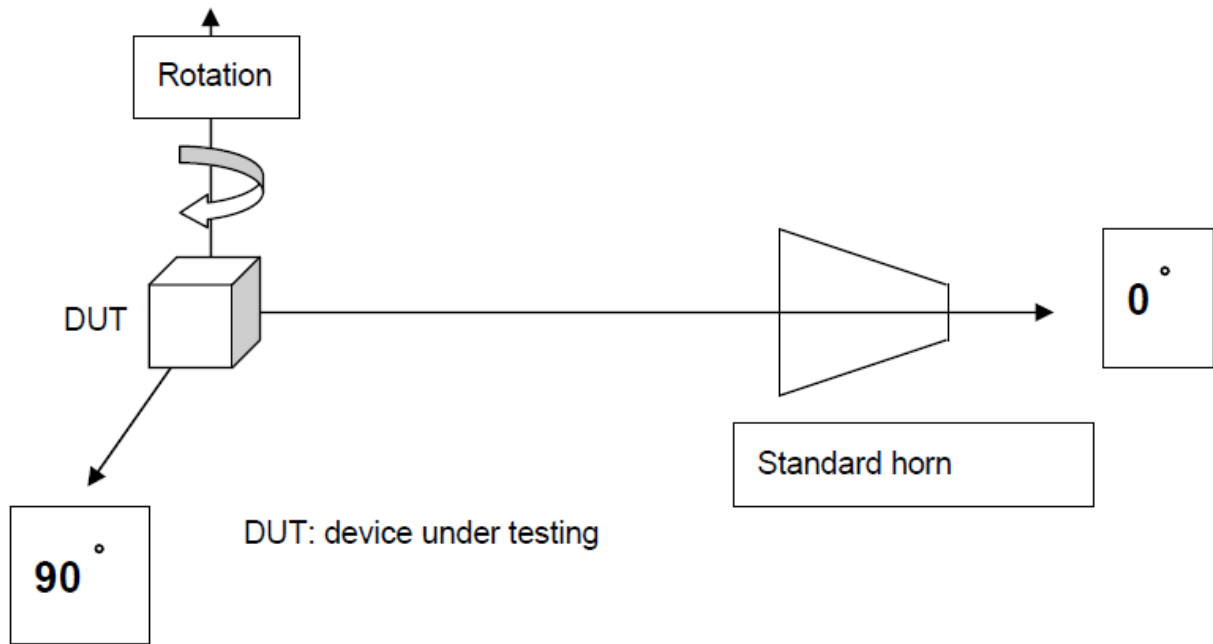

Figure 3. Schematic of measurement set-up

## 4.2. LNA

### a) Parameter Measurement

- a. Equipment: Network Analyzer (Agilent E5071B)(Fig.4)
- b.  $S_{11}$ ,  $S_{12}$ ,  $S_{21}$ ,  $S_{22}$

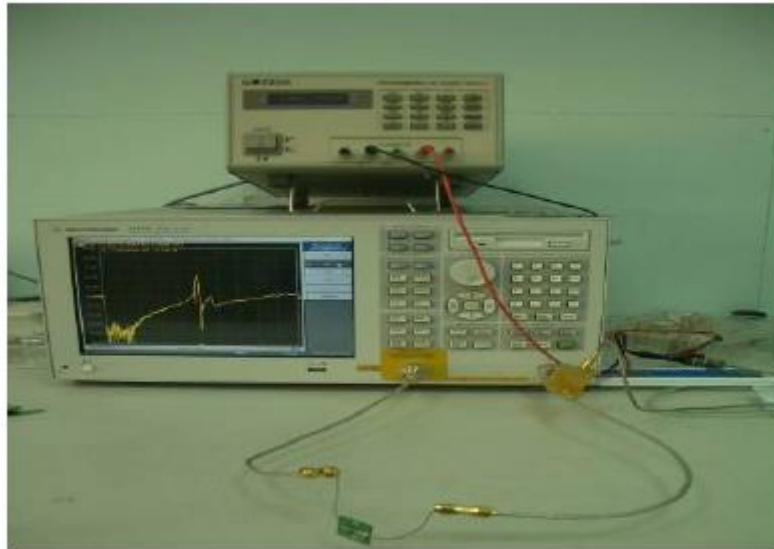

Figure 4. Network Analyzer

### a) Noise Figure Measurement

- a. Equipment: Noise Meter (Agilent E4407B)(Fig.5)
- b. Environment: Shielding Room (Fig. 6)
- c. Item: N.F (Noise Figure)



Fig. 5 Noise Meter



Fig.6 Shielding Room



## 5. Measured Values

### 5.1. Chip

#### 5.1.1. $S_{11}$ Smith Chart (Impedance)

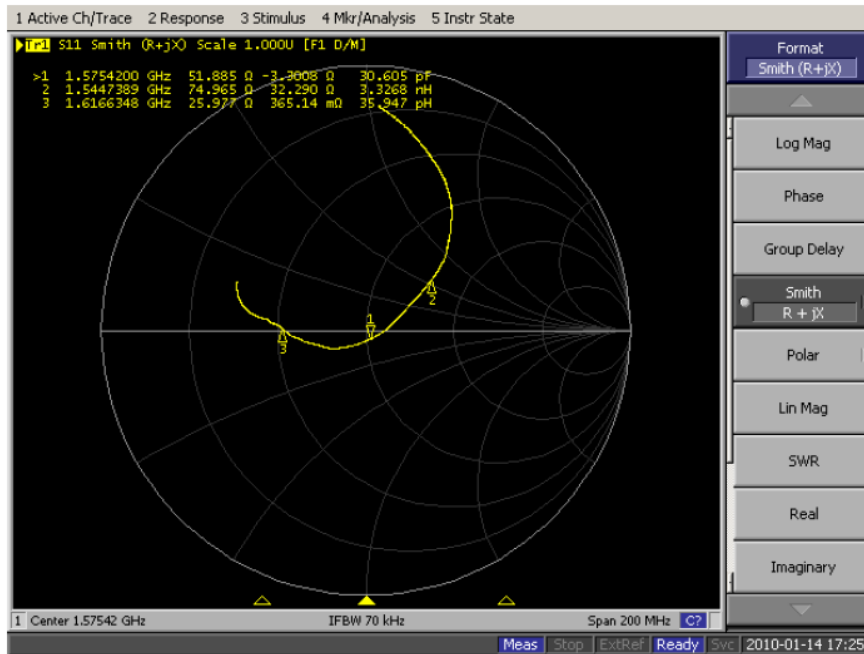

#### 5.1.2. $S_{11}$ Log Chart (Return Loss): Bandwidth $S_{11} < -10$ dB

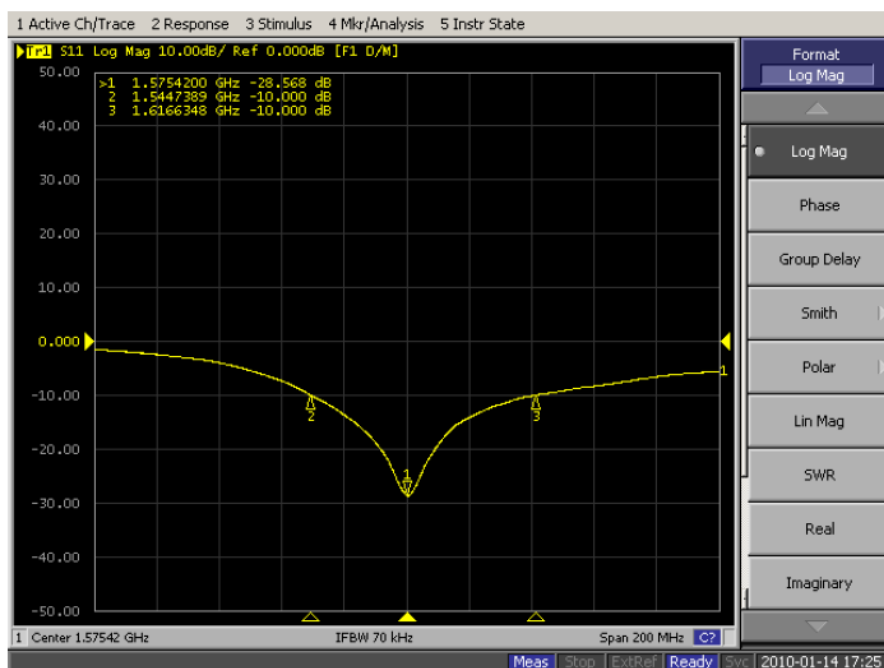

### 5.1.3. $S_{11}$ VSR

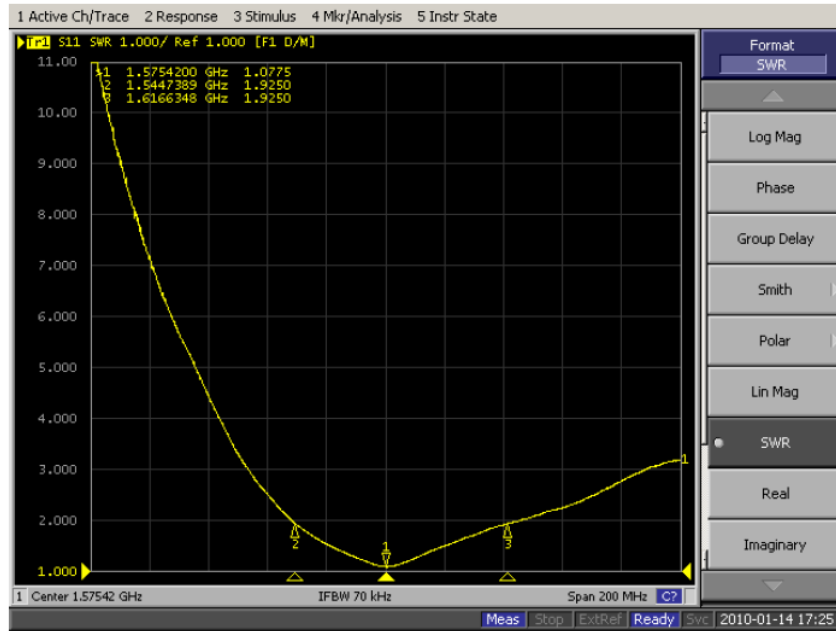

### 5.1.4. Radiation Patterns (Excluding LNA)

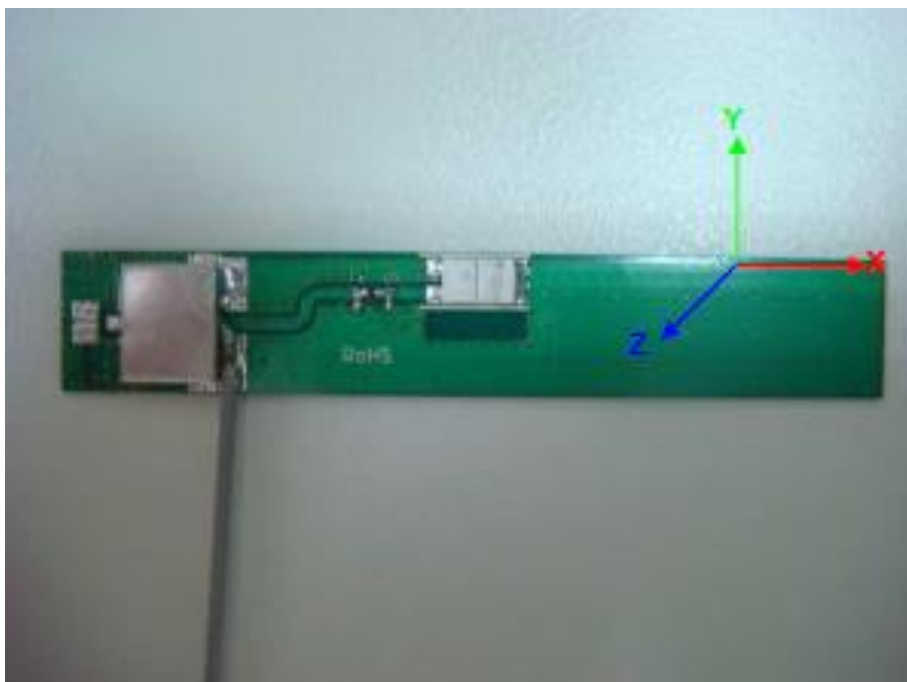

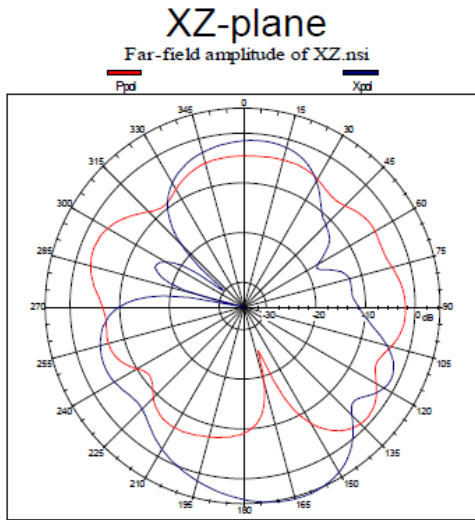

(Peak Gain = 4.92 dBi, Average Gain = -1.62 dBi )

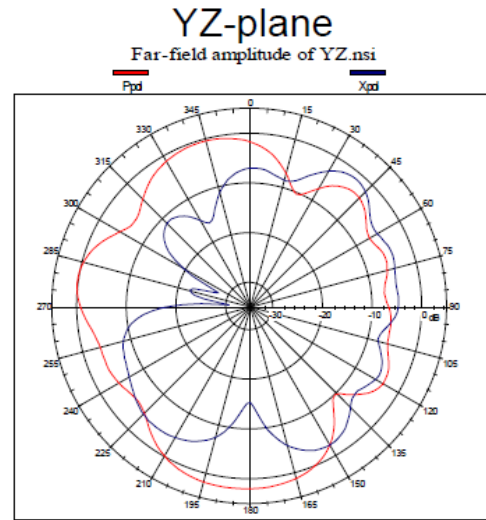

(Peak Gain = 1.89dBi, Average Gain = -1.57dBi )

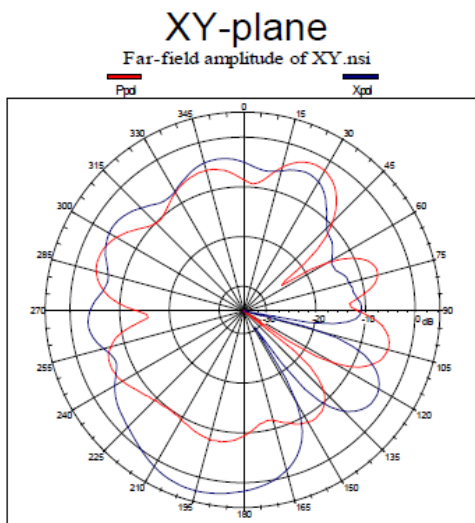

(Peak Gain = 2.75dBi, Average Gain = -3.44 dBi )

Plane	XZ	YZ	XY
Average Gain	-1.62	-1.57	-3.44
Peak Gain	4.92	1.89	2.75

Note: Total Gain = The total power of radiation pattern (exclude LNA Gain from GP8) + LNA Gain - cable loss (1.1dB/m)

## 5.2. Low Noise Amplifier (LNA)

### 5.2.1. $S_{11}$ (network analyzer input power -40dB)

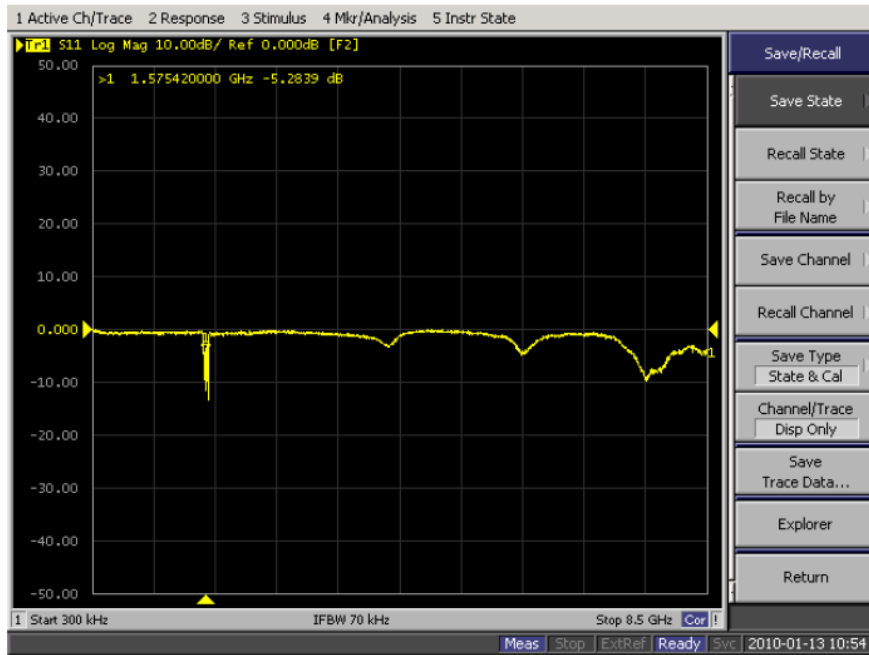

### 5.2.2. $S_{12}$ (network analyzer input power -40dB)

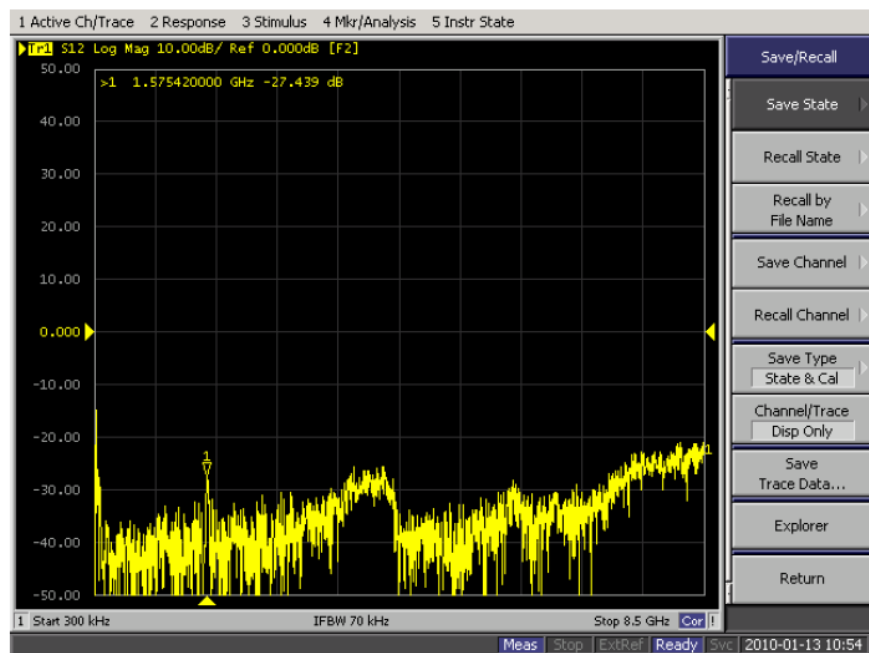

### 5.2.3. $S_{21}$ (Gain) (network analyzer input power -40dB)

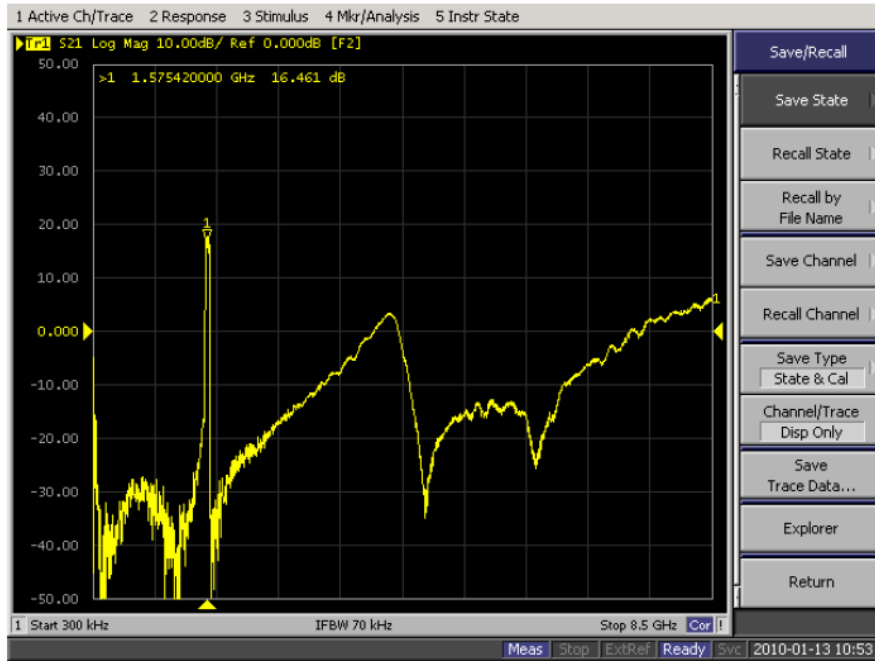

### 5.2.4. $S_{22}$ (Gain) (network analyzer input power -40dB)

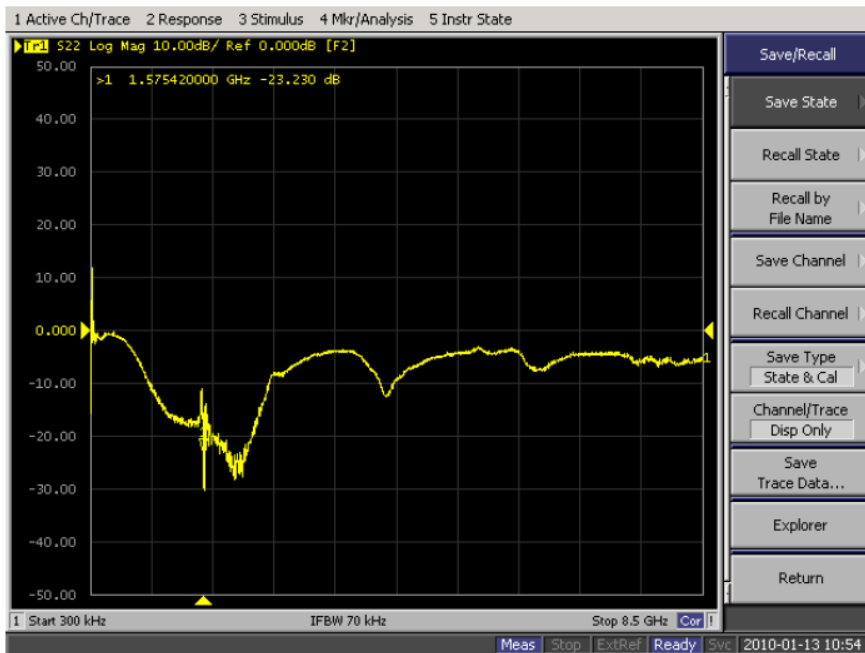

### 5.3. Noise Figure

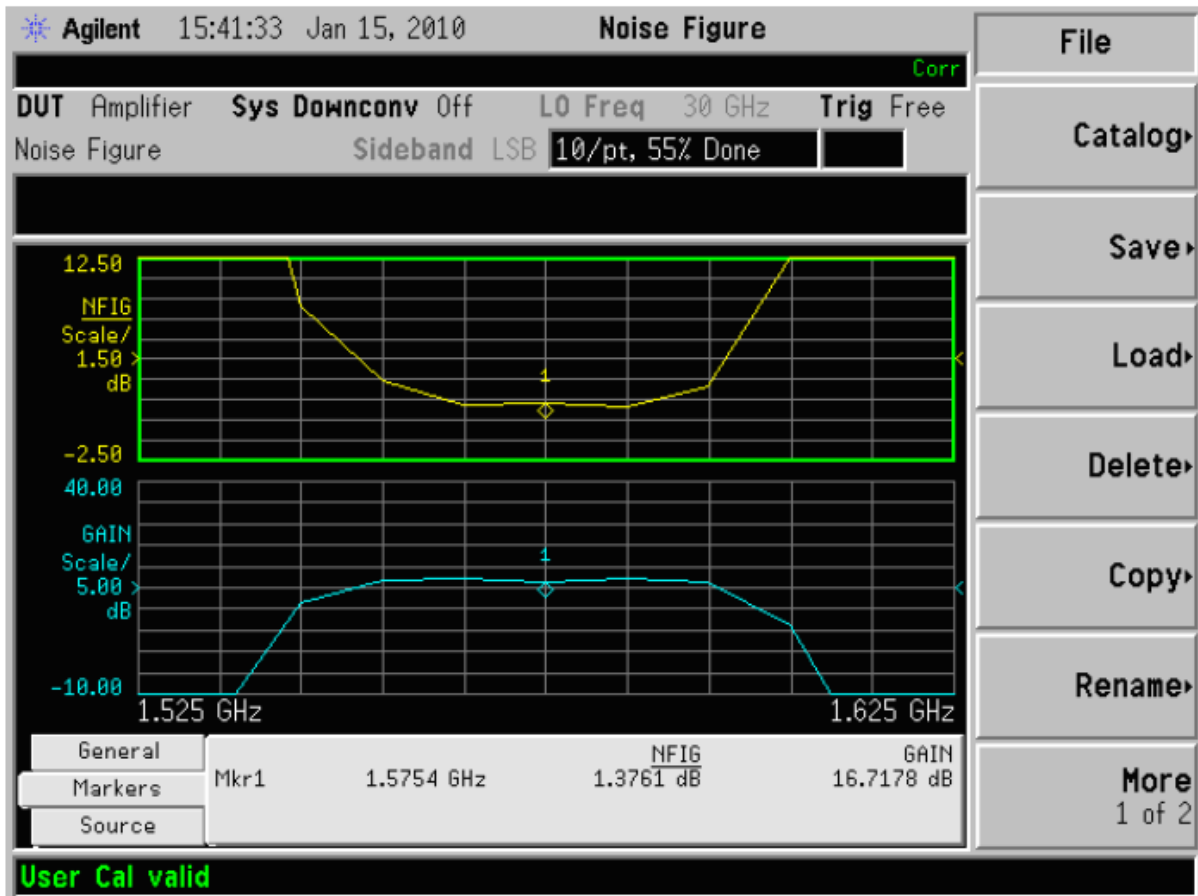

## 6. Drawing

### Top View

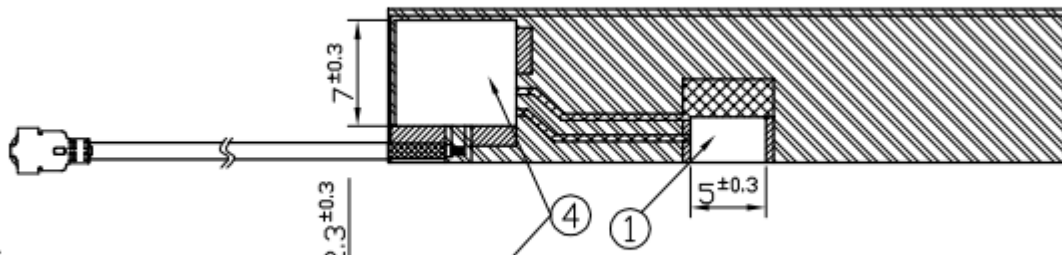

### Side View

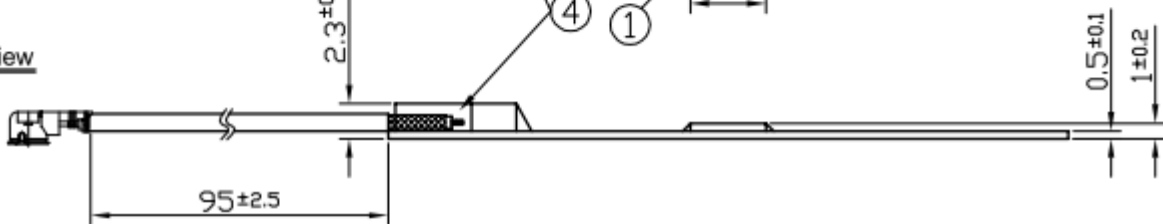

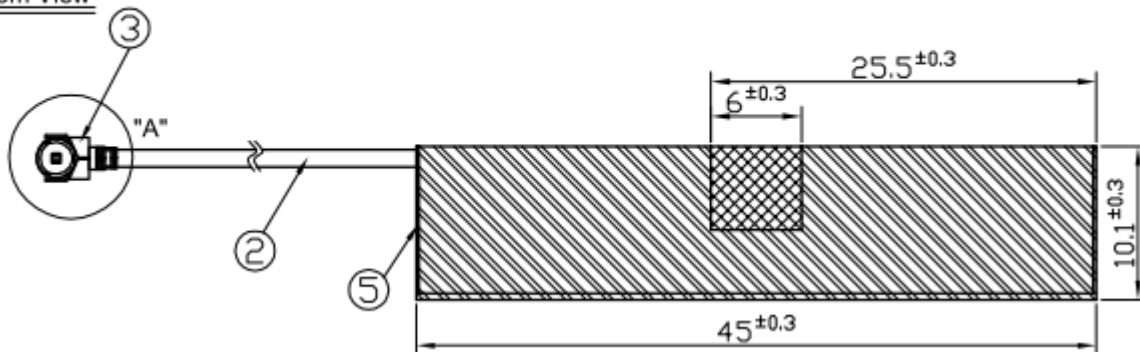

### Bottom View



1	Chip Antenna: 5*3*0.5mm
2	Cable Ø1.13 L=95±5mm
3	IPEX MHFI(U.FL)
4	Shielding Case
5	PCB

#### Note:

- 1.Soldered Area 
- 2.Solder Mask Area(Green) 
- 3.Ground Clearance 

Taoglas makes no warranties based on the accuracy or completeness of the contents of this document and reserves the right to make changes to specifications and product descriptions at any time without notice. Taoglas reserves all rights to this document and the information contained herein.

Reproduction, use or disclosure to third parties without express permission is strictly prohibited.

Copyright © Taoglas Ltd.