

SR-1000-XT DIN Rail Media Converters

 perle.com/products/media-converters/sr-1000xt-din-rail-copper-fiber-converters.shtml

Industrial Gigabit Copper to Fiber Converters

- 1000Base-T to 1000Base-X Fiber Media Converters
- Link copper to multimode or single mode fiber
- Dual fiber ST/SC or Single fiber SC connectors
- Extend network distances up to 10km
- -40°C to +75°C (-40°F to +167°F) extended operating temperature
- Advanced Features: Link Pass-Through, Far-End Fault, Auto-MDIX
- Triple Power Input: Dual Terminal block power connector & T-Bus



Perle **SR-1000-XT DIN Rail Media Converters** transparently connect UTP copper to fiber in industrial grade operating temperatures **-40°F to +167°F (-40°C to +75°C)**. Equipment found in **traffic management, oil and gas pipelines, weather tracking, industrial and outdoor applications** must function in temperatures that cannot be supported by a commercial based media converter. These **Gigabit Media Converters** are ideal for use with industrial devices subjected to harsh environments and severe temperatures such as security cameras, wireless access points, alarms, traffic controllers, sensors and tracking devices.

- Enable Gigabit speeds across a multimode fiber link up to 2km in length. (learn more)
- Extend the data transmission distance of IP-based devices by connecting their 1000Base-T copper interface to fiber.
- Extend the distance of an existing industrial network by linking CAT5/6/7 cabling to multimode or single mode fiber.
- Protect Ethernet data from EMI noise and interference by inter-connecting your copper-Ethernet devices over fiber in industrial plants.

An SR-1000-XT Media Converter is also available with an SFP slot.

Network Administrators "see-everything" with Perle's advanced features such as Auto-Negotiation, Auto-MDIX, Link Pass-Through, Far End Fault, and Pause which make the end to end link completely transparent. This allows for more efficient troubleshooting and less on-site maintenance. These cost and time saving features, along with a lifetime warranty and free worldwide technical support, make **SR-1000-XT Gigabit Media Converters** the smart choice for IT professionals.

SR-1000-XT Fiber Media Converter Features: 1000Base-T to 1000Base-X

Fully designed to operate in extreme temperatures

Perle SR-1000-XT Industrial Media Converters only use components that are fully qualified and rated to operate in -40F to +167F.

There are other products on the market that claim to operate at -40°F to +167°F however, they use "commercial-grade" components that have not been qualified by the manufacturer (OEM) to operate at the claimed temperature ranges. When "commercial-grade" parts are exposed to extremely high or low temperatures, product failures are inevitable. For example, integrated circuits on the PCB overheat causing premature failures. Under-rated connectors do not allow for proper contact between the device and the cables. These failures eventually stop all data communications in these high and low temperature environments.

By choosing Perle you can be confident you will not be subjected to these failures.

DIN Rail Enclosure	Easily mount on a DIN rail or inside distribution boxes using native DIN Rail enclosure with grounding clip. No need for add-on brackets.
Auto-Negotiation	<p>The media converter supports auto negotiation. The 1000Base-X fiber interface negotiates according to 802.3 clause 37. The 1000Base-T negotiates according to 802.3 clause 28 and 40. The 1000Base-X will link up with its partner after the highest common denominator (HCD) is reached and the copper has linked up with its partner. The 1000Base-X will continue to cycle through negotiation transmitting a remote fault of offline (provided this is enabled through the switch setting) until the copper is linked up and the HCDs match.</p> <p>The media converter supports auto-negotiation of full duplex, half duplex, remote fault, full duplex pause, asymmetric pause and Auto MDI-X.</p>
Auto-MDIX with Skew Correction	<p>Auto-MDIX (automatic medium-dependant interface crossover) detects the signaling on the 1000Base-T interface to determine the type of cable connected (straight-through or crossover) and automatically configures the connection when enabled. The media converter can also correct for wires swapped within a pair.</p> <p>The media converter will adjust for up to 64ns of delay skew between the 1000Base-T pairs.</p>
Smart Link Pass-Through	When Smart Link Pass-Through mode is enable, the Ethernet copper port will reflect the state of the Ethernet fiber media converter port. This feature can be used whether fiber auto-negotiation is enabled or disabled.
Fiber Fault Alert	With Fiber Fault Alert the state of the 1000Base-X receiver is passed to the 1000Base-X transmitter. This provides fault notification to the partner device attached to the 1000Base-X interface of the media converter. If the 1000Base-X transmitter is off, as a result of this fault, it will be turned on periodically to allow the condition to clear should the partner device on the 1000Base-X be using a similar technique. This eliminates the possibility of lockouts that occur with some media converters. Applies only when fiber auto-negotiation is disabled.
Pause (IEEE 802.3x)	Pause signaling is an IEEE feature that temporarily suspends data transmission between two devices in the event that one of the devices becomes overwhelmed. The media converter supports pause negotiation on the 1000Base-T copper connection and 1000Base-X fiber connection.
Duplex	Full and half duplex operation supported.
Jumbo Packets	Transparent to jumbo packets up to 10KB.
VLAN	Transparent to VLAN tagged packets.
Remote LoopBack	Capable of performing a loopback on the 1000Base-X fiber interface.

Hardware Specifications: SR-1000-XT Media Converters

Power

Input Supply Voltage	Triple voltage 12 / 24 / 48 VDC (9.6 – 60 VDC) input supporting: a) 2 x Terminal Block power input and b) 1 x T-Bus power input
Current	0.09 A (@ 24VDC)
Power Consumption	2.16 watts (@ 24VDC)
Power Connector	Dual input Terminal Block and/or T-Bus

Indicators

Power / TST	This green LED is turned on when power is applied to the media converter. Otherwise it is off. The LED will blink fast/slow when in Loopback test mode or hardware error.
Fiber link on / Receive activity (LKF)	On: Fiber link present. Blinking slowly: Fiber link disabled because of copper link loss. Blinking quickly: Fiber link present and receiving data. Off: No fiber link present
Copper link on / Receive activity (LKC)	On: Fiber link present. Blinking slowly: Fiber link disabled because of copper link loss. Blinking quickly: Fiber link present and receiving data. Off: No fiber link present

Switches - accessible by sliding the chassis open



Auto-Negotiation	<p>Auto (Default-Up): In this mode of operation the media converter will negotiate Ethernet parameters on both the copper and the fiber connection. This will ensure the most optimal connection parameters will be in effect. If connecting to another Perle Gigabit Media Converter, this parameter should be set to Auto.</p> <p>Off: The fiber Negotiation should only be turned off, if the fiber link partner does not support fiber link negotiations</p>
Smart Link Pass-Through	<p>Standard Mode (Default-Up): In this mode, if Fiber Negotiation is set to OFF, the links on the fiber and copper sides can be brought up and down independently of each other. A loss of link on either the fiber link or copper link can take place without affecting the other connection. However, if the Fiber Negotiation (switch 2) is set to Auto, then a loss of link on the copper side will result in a loss of link on the fiber side but not vice versa.</p> <p>Smart Link Pass-Through (Down): In this mode, the link state on one connection is directly reflected through the media converter to the other connection. If link is lost on one of the connections, then the other link will be brought down by the media converter.</p>

Pause	<p>Enabled (Default-Up): In this mode, when Fiber Negotiation has been turned off, the media converter will use this setting for its Ethernet parameter negotiation on the copper connection. With this Pause switch in the Enabled position, the media converter will advertise support for Symmetrical and Asymmetrical Pause.</p> <p>Disabled: The media converter will not advertise support for the Pause feature.</p>
Loopback	<p>Disabled (Default-Up): The loopback feature is disabled. This is the normal position for regular operation. The switch must be set to this position for data to pass through the media converter.</p> <p>Enabled: This is a test mode. All data received on the receive (RX) fiber connection is looped back to the transmit (TX) fiber connection. The state of the copper is not relevant and no data or link status is passed through to the copper side.</p>
Fiber Fault Alert (FFA)	<p>Enabled (Default-Up): In this mode, when Fiber negotiation is turned on, if the media converter detects a loss of fiber signal on the fiber receiver it will immediately disable its fiber transmitter signal. This notifies the fiber link partner that an error condition exists on the fiber connection. If the remote media converter is set up for FFA Enabled and the local media converter is set up with Smart Link Pass-Through, a loss of fiber link on either the transmit or receive line will be passed through to the local copper connection to notify the connected device. If the media converter has been set to Smart Link Pass-Through mode, the effect will be the same as FFA since the link loss on the fiber receiver will result in bringing down the copper link, which will in turn cause the transmit fiber link to be brought down.</p> <p>Disabled: In this mode, the media converter will not monitor for fiber fault.</p>
Duplex Mode	<p>Auto (Default-Up): In this mode, when Fiber Negotiation has been turned off, the media converter will use this Duplex setting for its Ethernet parameter negotiation on the copper connection. In the Auto position, the media converter will advertise support for both Full and Half Duplex mode. The resultant negotiation will provide the most optimum connection.</p> <p>Half: In this mode, the media converter will force the negotiation to Half Duplex mode</p>
Cables and Connectors	
1000Base-T	RJ45 connector, 4 pair CAT 5 (UTP or STP) or better cable
Fixed Fiber	Dual multimode or single mode (Duplex) fiber - SC, ST Single strand fiber (Simplex) – SC
Magnetic Isolation	1.5kv
Fiber Optic Cable	Multimode: 62.5 / 125, 50/125, 85/125, 100/140 micron Single Mode: 9/125 micron (ITu-T 625)
Filtering	
Filtering	1024 MAC Addresses
Frame Specifications	
Buffer	512 Kbits frame buffer memory

Size	Maximum frame size of 10,240 bytes
------	------------------------------------

Packet Transmission Characteristics

Bit Error Rate (BER)	<10 ⁻¹²
----------------------	--------------------

Environmental Specifications

Operating Temperature	-40 C to 75 C (-40 F to 167 F)
-----------------------	--------------------------------

Storage Temperature	-40 C to 85 C (-40 F to 185 F)
---------------------	--------------------------------

Operating Humidity	5% to 90% non-condensing
--------------------	--------------------------

Storage Humidity	5% to 95% non-condensing
------------------	--------------------------

Operating Altitude	Up to 3,048 meters (10,000 feet)
--------------------	----------------------------------

Heat Output (BTU/HR)	7.37
------------------------	------

MTBF (Hours)	695,274 (Calculation model based on MIL-HDBK-217-FN2 @ 30 °C)
--------------	---

Chassis	Molded plastic DIN Rail case with an IP20 ingress protection rating
---------	---

Mounting

Din Rail Kit	Native
--------------	--------

Product Weight and Dimensions

Weight	0.12 kg, 0.26 lbs
--------	-------------------

Dimensions	114 x 100 x 22.5mm, 4.5 x 3.9 x 0.88 inches
------------	---

Packaging

Shipping Weight	0.17 kg, 0.37 lbs
-----------------	-------------------

Shipping Dimensions	145 x 105 x 30 mm, 5.7 x 4.1 x 1.2 inches
---------------------	---

Regulatory Approvals

Emissions	FCC 47 Part 15 Class A, EN55032 (CISPR32) Class A EN55011 (CISPR11) ICES-003 EN61000-6-4 (Emissions for industrial environments) CISPR 32:2015/EN 55032:2015 (Class A) CISPR 24:2010/EN 55024:2010 EN61000-3-2
Immunity	EN55024 EN 61000-4-2 (ESD) EN 61000-4-3 (RS) EN 61000-4-4 (EFT) EN 61000-4-5 (Surge) EN 61000-4-6 (CS) EN 61000-4-8 (PFMF) EN 61000-4-11 IEC/EN 61000-6-2 (General Immunity for Industrial Environments)
Electrical Safety	IEC 62368-1(ed 2) EN 62368-1:2014 CE
Laser Safety	EN 60825-1:2007 Fiber optic transmitters on this device meet Class 1 Laser safety requirements per IEC-60825 FDA/CDRH standards and comply with 21CFR1040.10 and 21CFR1040.11.
Environmental	Reach, RoHS and WEEE Compliant
Other	ECCN: 5A991 HTSUS Number: 8517.62.0020 Perle Limited Lifetime Warranty

Gigabit to IP Cameras

Connect IP Cameras to Gigabit Backbone

Extend the reach to IP cameras using industrial fiber media converters. Security cameras are typically installed in remote locations where extremely high or low temperatures are a concern -- ceilings, rooftops, light poles, along fences, pipelines and transit routes.

Stand-alone Extended Temperature Media Converters are placed at the remote end connecting cameras with copper interfaces to fiber optic cabling. The fiber can extend the distance up to 10 kilometers using single mode or multimode fiber back to a control center. A media converter chassis located in the data closet at the control center accepts the fiber signal, converts it, and connects to the copper equipment at the main site.

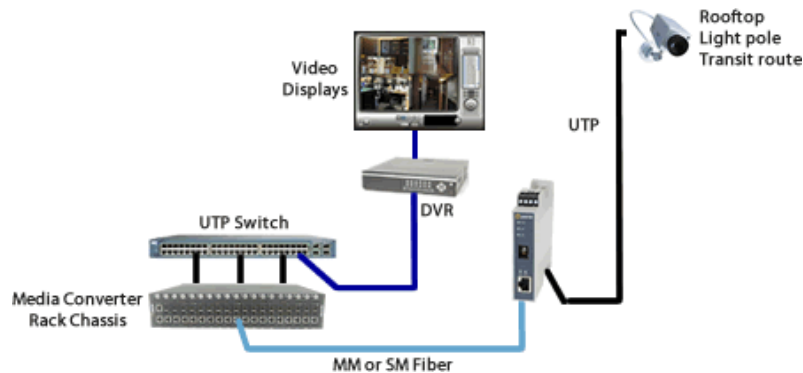

Gigabit Fiber to Wireless Access Points

Connect Wireless Access Points to Gigabit Backbone

Extend the reach to wireless access points (AP) using fiber media converters. When a company deploys a wireless network in their office or large warehouse, APs need to be set up throughout the facility to ensure complete coverage for reliability. The network manager will likely need to extend further than the 100 meters allowed by copper cable to reach many of the APs.

When APs are used in industrial environments where extremely high or low temperatures are a concern, Stand-alone Extended Temperature Media Converters are placed at the remote end connecting APs with copper interfaces to fiber optic cabling. The fiber can extend the distance up to 10 kilometers using single mode or multimode fiber back to a control center. A media converter chassis located in the data closet at the control center accepts the fiber signal, converts it, and connects to the copper equipment at the main site.

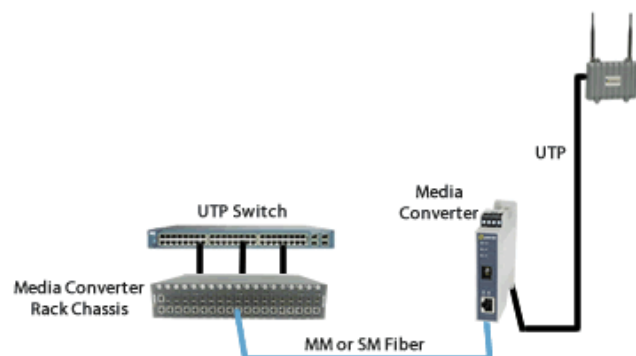

Extend between two UTP Gigabit Switches

Extend the network distance between two twisted pair Gigabit Switches

Two Gigabit Ethernet Media Converters can extend the distance between 1000Base-T Switches across a fiber link up to 10Km in length.

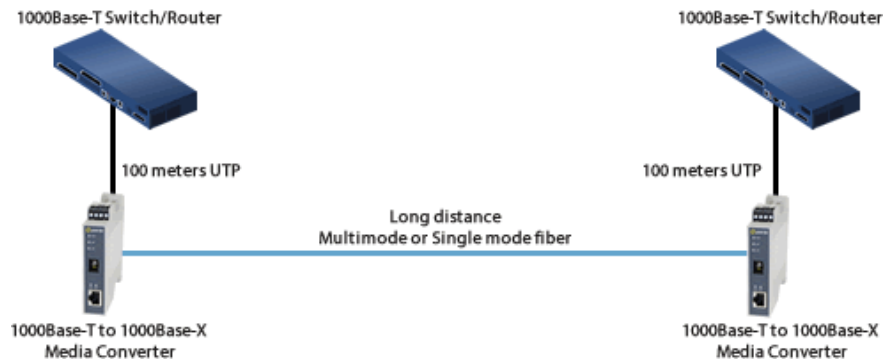

Gigabit UTP Switch to Fiber Switch

Interconnect a UTP Switch with a Fiber Switch

A media converter can interconnect a UTP copper based Switch port to a remote switch that has integrated fiber.

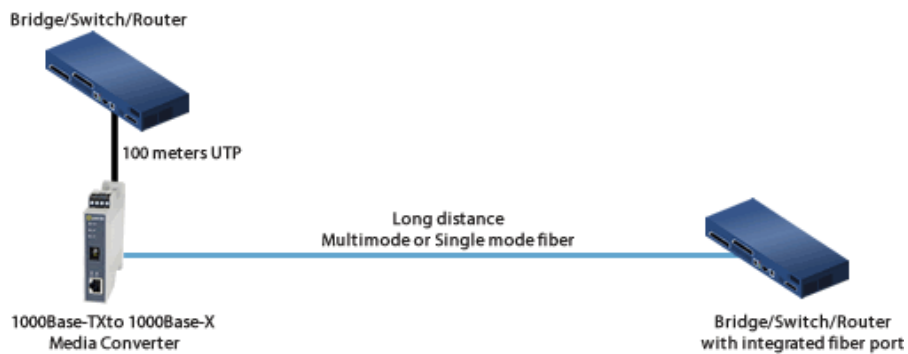

Switch to Gigabit Server

Extend the network distance between a Gigabit Switch and a Gigabit File Server

Two Gigabit Ethernet Media Converters can extend the distance between a 1000Base-T Switch and a Gigabit File Server across a fiber link up to 10Km in length.

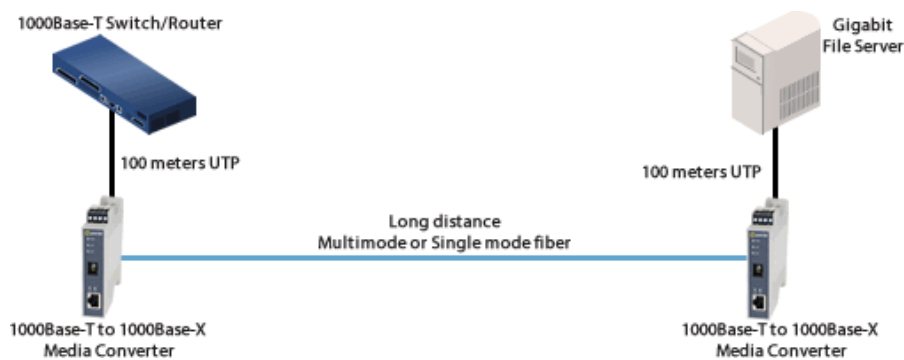

Direct Connect - Long Distance

Direct Connection between two remote devices

With a pair of Gigabit Media Converters two devices, such as file servers, can be connected up to 10km away across a fiber link.



Enterprise Infrastructure

Enterprise Infrastructure using Fiber Optics

Create a fiber infrastructure for your enterprise network without any wholesale replacement of existing copper-based equipment.

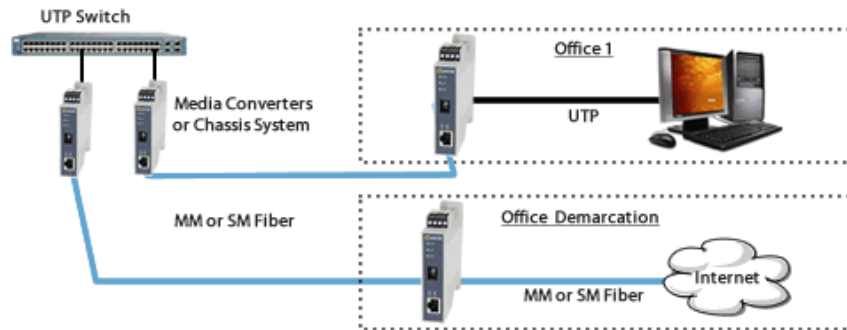

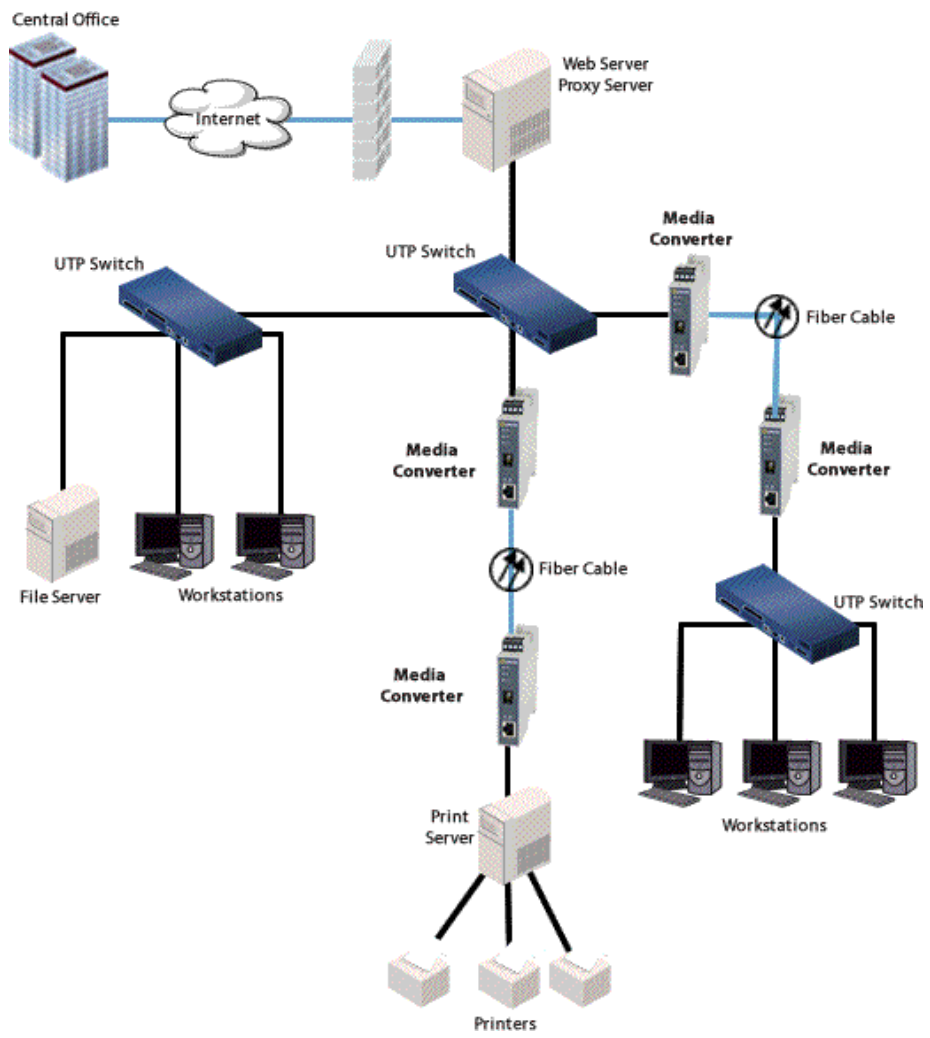

Single Mode / Single Fiber

Connect copper ports over a single fiber strand (also referred to as “Bi-Directional” BiDi)

When Single Strand fiber is used, a pair of Single Fiber Media Converters is needed for the copper to fiber conversion. Perle Single Fiber Media Converters are also referred to as “Up/Down” models. For example the SR-1000-SC10U (“Up”) and SR-1000-SC10D (“Down”), shown below, must be used in pairs. An “Up” must be matched with a “Down” peer to deal with transmit and receive frequencies separately.

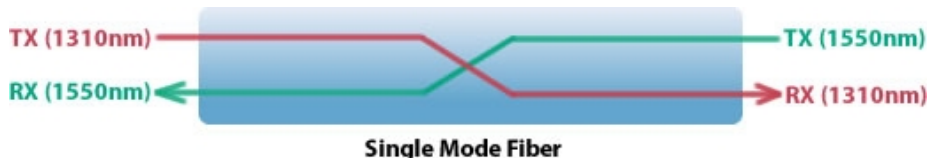

SR-1000-SC10USR-1000-SC10D

The majority of installations for single mode fiber media converters are of the “dual connector” or “dual fiber” type where one fiber connection is used for transmit, the other for receive. These are physically “crossed” to match up the Transmit/Receive links.

However, to reduce costs, or where there are limits on available fiber, WDM technology may be utilized. WDM uses separate transmit and receive frequencies to communicate on a single fiber strand. WDM technology relies on the fact that optical fibers can carry many wavelengths of light simultaneously without interaction between each wavelength. Thus, a single fiber can carry many separate wavelength signals or channels simultaneously.

So remember, if Single Strand fiber is used, you will need an “Up” Media Converter on one side and a “Down” Media Converter on the other for copper to fiber conversion.

Perle offers a wide variety of Single Fiber (“Up/Down”) Media Converters to connect 10BaseT, Fast Ethernet and Gigabit to single fiber. Whether you need Managed or Unmanaged, Standalone or Modular Chassis Based, 20km or 120km, Perle has the right model to meet your fiber conversion requirement.

Select a Model to obtain a Part Number - SR-1000-XT DIN Rail Media Converters

Dual Fiber Models

Model	Connector	Type	Transmit (dBm)		Receive (dBm)		Power Budget (dBm)	Wavelength (nm)	Fiber Type	Core Size (um)	Modal Bandwidth (MHz* Km)	Operating Distance
			Min	Max	Min	Max						
SR-1000-SC05-XT	Dual SC	1000Base-SX	-9.5	-4.0	-17.0	-3.0	7.5	850	MMF	62.5	160	220 m (722 ft)
			62.5	200	275 m (902 ft)							
			50	400	500 m (1,640 ft)							
			50	500	550 m (1,804 ft)							
			50	2000	1000 m (3281 ft)							

SR-1000-ST05-XT	Dual ST	1000Base-SX	-9.5	-4.0	-17.0	-3.0	7.5	850	MMF	62.5	160	220 m (722 ft)
										62.5	200	275 m (902 ft)
										50	400	500 m (1,640 ft)
										50	500	550 m (1,804 ft)
										50	2000	1000 m (3281 ft)
SR-1000-SC10-XT	Dual SC	1000Base-LX/LH	-9.5	-3.0	-20.0	-3.0	10.5	1310	MMF*	62.5	500	550 m (1804 ft)
										50	400	550 m (1,804 ft)
										50	500	550 m (1,804 ft)
										SMF	**	-
									SR-1000-ST10-XT	Dual ST	1000Base-LX/LH	-9.5
50	400	550 m (1,804 ft)										
50	500	550 m (1,804 ft)										
SMF	**	-	10 km (6.2 mi)									

Single Fiber Models Recommended use in pairs



Model	Connector	Type	Transmit (dBm)		Receive (dBm)		Power Budget (dBm)	Wavelength (nm)	Fiber Type	Core Size (um)	Modal Bandwidth (MHz* Km)	Operating Distance
			Min	Max	Min	Max						
SR-1000-SC10U-XT	Single SC	1000Base-BX-U	-9.0	-3.0	-20.0	-3.0	11.0	1310 / 1490	SMF	**	-	10 km (6.2 mi)





SR-1000-SC10D-XT	Single SC	1000Base-BX-D	-9.0	-3.0	-20.0	-3.0	11.0	1490 / 1310	SMF	**	-	10 km (6.2 mi)
------------------	-----------	---------------	------	------	-------	------	------	-------------	-----	----	---	----------------

*A mode-conditioning adapter as specified by the IEEE standard, is required regardless of the span length. Note how the mode conditioning adapter for 62.5-um fibers has a different specification from the mode-conditioning adapter for 50-um fibers.

**ITU-T G.652 SMF as specified by the IEEE 802.3z standard.



Part Number	Media Converter Accessories
29029928	UNO-PS/1AC/24DC/60W DIN-Rail Power Supply: 24 VDC, 60 Watt with universal 85 to 264 VAC, -25 to 70°C extended operating temperature.
29043768	UNO-P/1AC/24DC/150W Power Supply - DIN-Rail 24 VDC , 150 Watt power supply with universal 85 to 264 VAC, -25 to 70°C extended operating temperature
28664918	TRIO-PS/1AC/48DC/5 DIN-Rail Power Supply: 48 VDC, 240 Watt with universal 85 to 264 VAC, 30 to 56V DC output range adjustable, -25 to 70°C extended operating temperature.
28665018	TRIO-PS/1AC/48DC/10 Power Supply - DIN-Rail 48 VDC , 480 Watt power supply with universal 85 to 264 VAC, 30 to 56V DC output range adjustable, -25 to 70°C extended operating temperature
28669838	MINI-SYS-PS-100-240AC/24DC/1.5 Power Supply - For use with modular TBUS DIN rail connector system. 24VDC / 1.5 A, 36 Watts with universal 85 to 264 VAC, -25 °C to 70 °C extended operating temperature
22038528	ME225TBUS15/4P1SBK - TBUS DIN Rail Connector - Transmit power voltage and data across the bus. 4 parallel positions and 1 serial position. UL 8A / cUL 6A, 150 V. Width 22.5cm. Carton of 5. For use with SR and SRS DIN Rail Media Converters.

Product Image	Description	Power Cord	Product Number
	SR-1000-SC05-XT - Gigabit Industrial Media Rate Converter: 1000Base-T (RJ-45) [100 m/328 ft] to 1000BASE-SX 850nm multimode (SC) [550 m/1804 ft], -40F to +167F (-40C to +75C) extended operating temperature support. DIN Rail case, terminal block (Combicon) power connector for external power source	None	05091560
	SR-1000-ST05-XT - Gigabit Industrial Media Rate Converter: 1000Base-T (RJ-45) [100 m/328 ft] to 1000BASE-SX 850nm multimode (ST) [550 m/1804 ft], -40F to +167F (-40C to +75C) extended operating temperature support. DIN Rail case, terminal block (Combicon) power connector for external power source	None	05091570

Product Image	Description	Power Cord	Product Number
	SR-1000-SC10-XT - Gigabit Industrial Media Rate Converter: 1000Base-T (RJ-45) [100 m/328 ft] to 1000BASE-LX/LH 1310 nm single mode (SC) [10 km/6.2 miles], -40F to +167F (-40C to +75C) extended operating temperature support. DIN Rail case, terminal block (Combicon) power connector for external power source	None	05091580
	SR-1000-ST10-XT - Gigabit Industrial Media Rate Converter: 1000Base-T (RJ-45) [100 m/328 ft] to 1000BASE-LX/LH 1310 nm single mode (ST) [10 km/6.2 miles], -40F to +167F (-40C to +75C) extended operating temperature support. DIN Rail case, terminal block (Combicon) power connector for external power source	None	05091590
	SR-1000-SC10U-XT - Gigabit Industrial Media Rate Converter: 1000Base-T (RJ-45) [100 m/328 ft] to 1000BASE-BX 1310nm TX / 1490nm RX single strand fiber, single mode (SC) [10 km/6.2 miles], -40F to +167F (-40C to +75C) extended operating temperature support. DIN Rail case, terminal block (Combicon) power connector for external power source	None	05091600
	SR-1000-SC10D-XT - Gigabit Industrial Media Rate Converter: 1000Base-T (RJ-45) [100 m/328 ft] to 1000BASE-BX 1490nm TX / 1310nm RX single strand fiber, single mode (SC) [10 km/6.2 miles], -40F to +167F (-40C to +75C) extended operating temperature support. DIN Rail case, terminal block (Combicon) power connector for external power source	None	05091610

Accessories

Accessory Image	Description	Model Number	Accessory Number
Power Supply			
	TRIO-PS/1AC/48DC/5 DIN-Rail Power Supply: 48 VDC, 240 Watt with universal 85 to 264 VAC, 30 to 56V DC output range adjustable, -25 to 70°C extended operating temperature.	TRIO-PS/1AC/48DC/5 Power Supply	28664918

Accessory Image	Description	Model Number	Accessory Number
	<p>TRIO-PS/1AC/48DC/10 Power Supply - DIN-Rail 48 VDC , 480 Watt power supply with universal 85 to 264 VAC, 30 to 56V DC output range adjustable, -25 to 70°C extended operating temperature</p>	<p>TRIO-PS/1AC/48DC/10 Power Supply</p>	<p>28665018</p>
	<p>MINI-SYS-PS-100-240AC/24DC/1.5 Power Supply - For use with modular TBUS DIN rail connector system. 24VDC / 1.5 A, 36 Watts with universal 85 to 264 VAC, -25 °C to 70 °C extended operating temperature</p>	<p>MINI-SYS-PS-100-240AC/24DC/1.5 Power Supply</p>	<p>28669838</p>
	<p>UNO-PS/1AC/24DC/60W DIN-Rail Power Supply: 24 VDC, 60 Watt with universal 85 to 264 VAC, -25 to 70°C extended operating temperature.</p>	<p>UNO-PS/1AC/24DC/60W Power Supply</p>	<p>29029928</p>
	<p>UNO-PS/1AC/24DC/150W Power Supply - DIN-Rail 24 VDC , 150 Watt power supply with universal 85 to 264 VAC, -25 to 70°C extended operating temperature</p>	<p>UNO-PS/1AC/24DC/150W Power Supply</p>	<p>29043768</p>