

REV.	ECN NO.	DATE	SIGN	DESCRIPTION

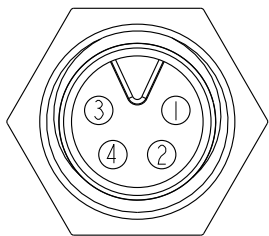

Pin Assignment
Front View

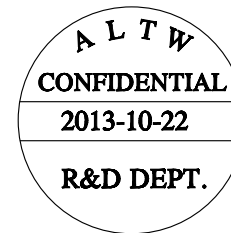
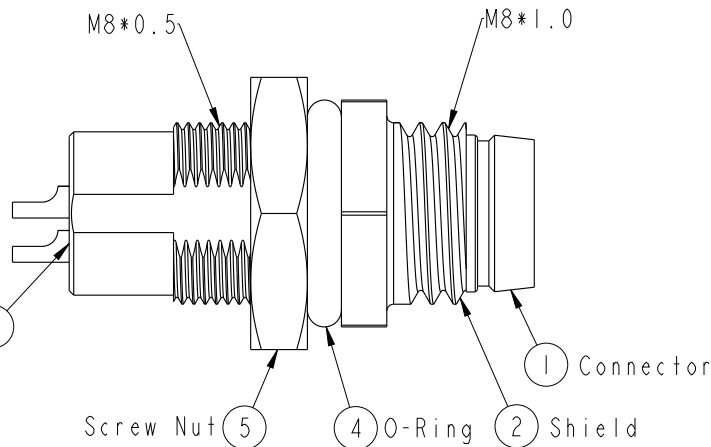
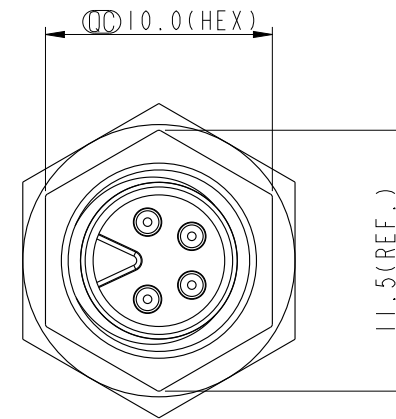
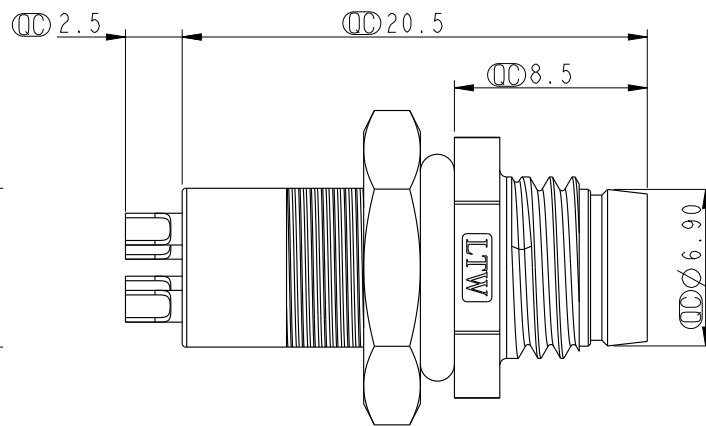
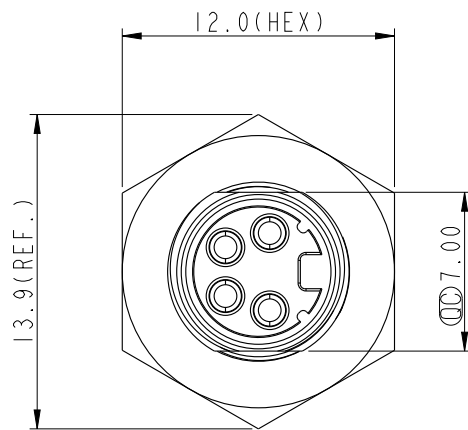
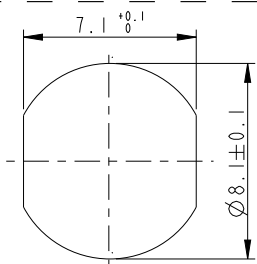

Recommended
Panel Cut-Out

Note:

- * \varnothing Important Dimension.
- * Waterproof Rate: IP67.
- * Housing: Nylon+GF, Black.
- * Male Pin: Copper Alloy, Gold Plated.
- * Shield: Zinc Alloy, Nickel Plated.
- * Screw Nut: Copper Alloy, Nickel Plated.
- * O-Ring: EPDM, Black.
- * For Panel Thickness Max 3.5mm.
- * Nut Torque: 4-6 kgf.cm.

UNIT:mm

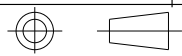

TOLERANCE	
.X	±0.25
.XX	±0.1
.XXX	±0.05
ANGLES	±1°

TITLE M8 4Pin Panel M Conn. M Pin			
SCALE 3:1	SIZE A4	SHEET 1 OF 1	
REV. A	WC-REV. A.1	\varnothing : Inspection item	

Amphenol LTW
安費諾亮泰企業股份有限公司

ITEM NO. 8A-04PMMS-SH7001	DRAWN BY Tony_leng	DATE 2013-10-22
DWG NO. 8A-04PMMS-SH7001	CHECKED BY Jimmy	DATE 2013-10-22
CUSTOMER ALTW	APPROVED BY Jerry	DATE 2013-10-22

THIS DOCUMENT IS SUBJECT TO CHANGE WITHOUT NOTICE. IT IS CONFIDENTIAL AND A PROPERTY OF AMPHENOL LTW. DISCLOSURE TO THIRD PARTY HAS TO BE AUTHORIZED BY AMPHENOL LTW.