



## Clock Oscillator SMD-version

+3,3V

model	KXO-V97T
frequency	3,68640 MHz
frequency stability at -40° ~ +85°C	± 100 ppm
operating temperature	-40° ~ +85°C
storage temperature	-40° ~ +85°C
symmetry	50% ± 10% at ½ V <sub>DD</sub> level
rise & fall time max.	6 ns
"0" level max.	+ 0,4V
"1" level min.	V <sub>DD</sub> -0,5V
input voltage V <sub>DD</sub>	+ 3,3V ± 10%
input current	4,0 mA typ., 6,0 mA max.
output load	30 pF
start up time max.	10 ms
tristate function	yes
disable delay time	100 ns max.
enable delay time	4 ms max.
random jitter	7ps max.
peak to peak jitter	40ps max.
contents of reel	1000 pcs.
part no.	12.94456

### Dimensions (mm):

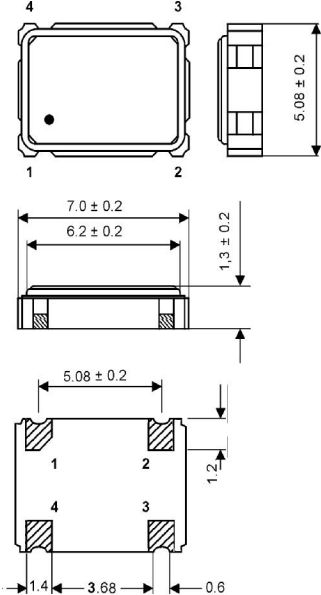

### Output waveform:

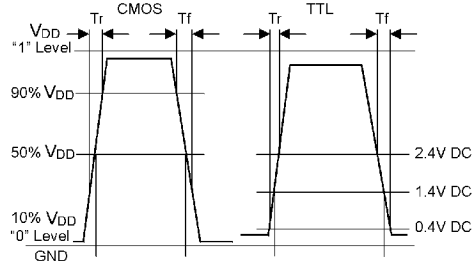

### Reflow soldering condition:

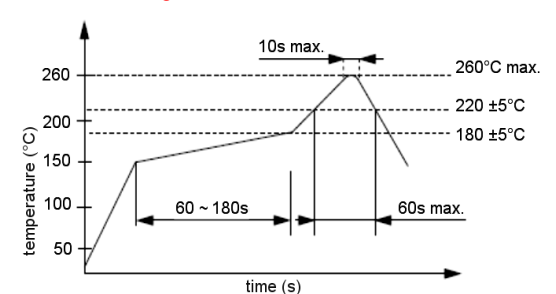

### Test circuit:

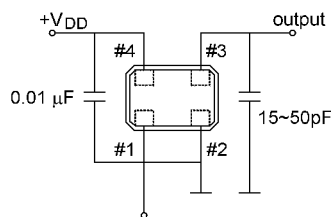

### Tape specifications:

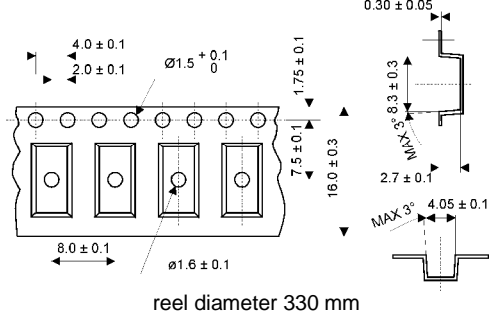

### Suggested soldering pad:

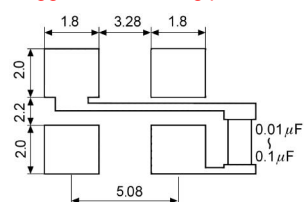

PIN	CONNECTION
1	"L" (OV) "H" or OPEN
2	GND
3	OUTPUT
4	V <sub>DD</sub>

Z: high impedance