

REV.	ECN NO.	DESCRIPTION	SIGN	DATE
C1	N/A	INITIAL DRAWING	Liu	2020/05/17

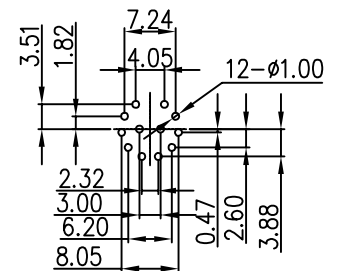

12 Pin  
PCB Layout

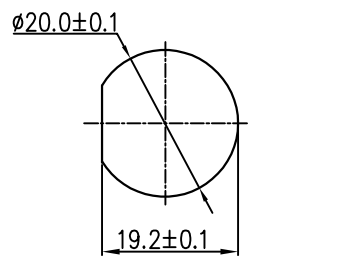

Recommended Panel Cut-Out

23XXX635-02  
Pin Number

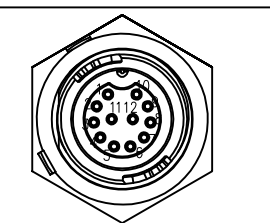

12 Pin

P/N: 23012635-02

Pin Assignments Front View

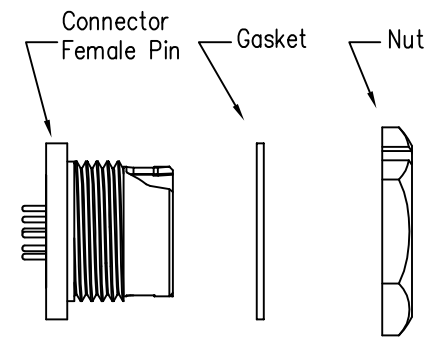
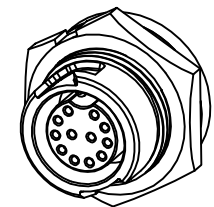
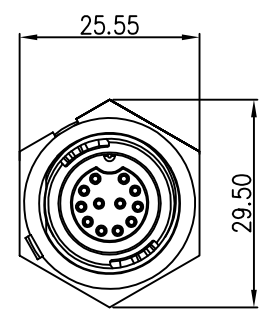
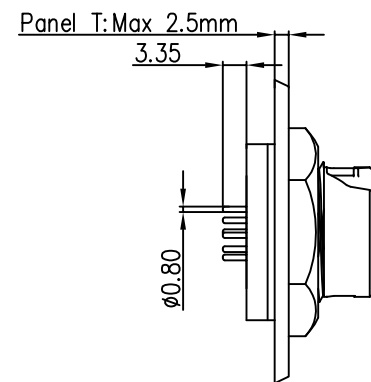
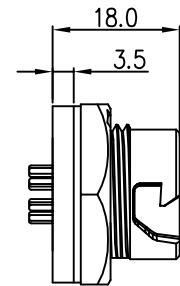

- Specification:
- 1.Operation Temperature: -45°C~105°C.
  - 2.Insulation Resistance: 100MΩ at DC500V.
  - 3.Contact Resistance: <10mΩ.
  - 4.Withstand Voltage: 1000V AC
  - 5.Operating Current: 2A
  - 6.Operating Voltage: DC 30V
  - 7.Waterproof Rate: IP67 (Mated)
  - 8.Housing: Nylon, Black
  - 9.Female Pin: Copper Alloy, Gold Plated
  - 10.Gasket: Silicon Gray
  - 11.Panel Nut: Nylon, Black
  - 12.Torque Rate: 0.8~1.0N·m
  - 13.RoHS Compliant.
  - 14.Mating Cap P/N: 806-00021-00

UNIT: mm	
TOLERANCE	
.X	±0.25
.XX	±0.15
.XXX	±0.05
ANGLES	±1°

DESCRIPTION	Middle Series Push Lock Front Mount With Female Pin		
SCALE:	1:1	SHEET	1 OF 1
REV.	C1	SIZE	A4
			* : Inspection Item

**CHOGORI**

PART NO	23012635-02	DRAWN BY	Liu	DATE	2020/05/17
DWG NO		CHECKED BY	Mo	DATE	2020/05/17
CUSTOMER		APPROVED BY	Adley	DATE	2020/05/17

THIS INFORMATION IS CONFIDENTIAL AND IS DISCLOSED TO YOU ON CONDITION THAT NO FURTHER DISCLOSURE IS MADE BY YOU TO OTHER THAN CHOGORI PERSONNEL WITHOUT AUTHORIZATION FROM CHOGORI CORP.