

## SUMMARY



Image is for illustrative purpose only

### # Wires

Low voltage 2

Series	3B
Termination type	Male crimp
IP rating	50
AWG wire size	14.00 - 10.00
Cable Ø	0.00 - 0.00 mm
Status	active
Matching parts	<a href="#">FGJ.3B.302.CYMD12</a>

### Download

[Request a quote](#)

[Eplan](#)

[Catalog](#)

## TECHNICAL DETAILS

### Mechanics

Shell Style/Model	EC*: Fixed receptacle with two nuts (back panel mounting)
Keying	2 keys (alpha=37.5, plug: female contacts, receptacle: male contacts)
Housing Material	Brass (chrome plated [SAE AMS 2460]) shell and collet nut, nickel plated [SAE AMS QQ N 290] brass latch sleeve and mid pieces
Weight	28.19 g

### Performance

Configuration	3B.302 : 2 Low Voltage
Insulator	Y: PEEK for crimp contacts
Rated Current	35 Amps

### Specifications

Contact Type:	Crimp
Contact Retention:	75 N
Contact Dia.:	3 mm (0.118in)
Bucket Dia.:	2.9 mm (0.114in)
Min. Conductor:	2.5 mm <sup>2</sup> (AWG 14)
Max. Conductor:	4 mm <sup>2</sup> (AWG 10)
R (max):	3.1 mOhm
Vtest (contact-shell):	1800 V (AC), 2550 V (DC)

LEMO products and services are provided "as is". LEMO makes no warranties or representations with regard to LEMO product & services or use of them, express, implied or statutory, including for accuracy, completeness, or security. The user is fully responsible for his products and applications using LEMO components.

Vtest (contact-contact): 2300 V (AC), 3250 V (DC)

## Others

Endurance (Shell): 5000  
Temp (min / max): -55°C / +250°C  
Humidity (max): ≤95% [at 60 deg C / 140 F]  
Vibration: 15 g [10 Hz - 2000 Hz]  
Shock Resistance: 100 g [ 6 ms]  
Climatical Category: 50/175/21  
Shielding (min): 75 dB (10 MHz)  
Shielding (min): 40 dB (1 GHz)  
Salt Spray Corrosion: >1000 hr

## DRAWINGS

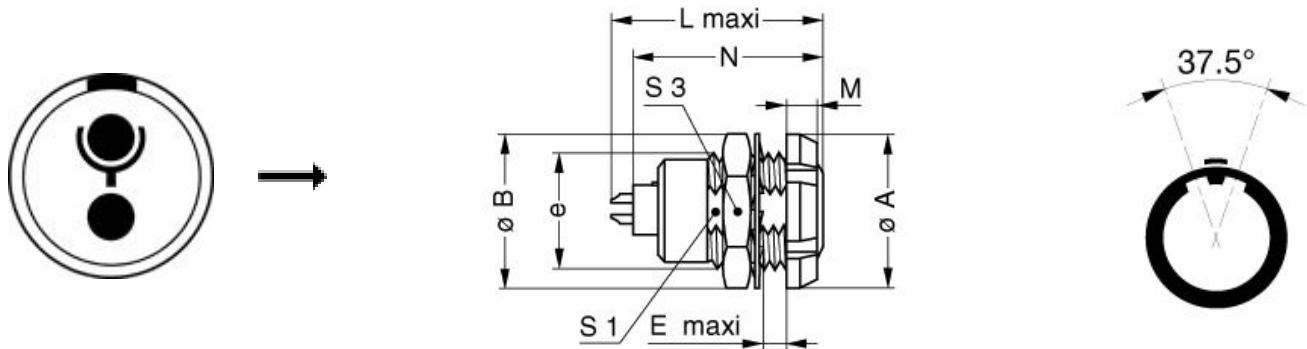

## Dimensions

	A	B	E	L	M	N	S1	S3	e
mm.	24	25	9	30.7	4.5	28.1	16.5	22	M18x1.0
in.	0,94	0,98	0,35	1,21	0,18	1,11	0,65	0,87	



























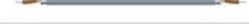

## RECOMMENDED BY LEMO

### Tools





LEMO products and services are provided "as is". LEMO makes no warranties or representations with regard to LEMO product & services or use of them, express, implied or statutory, including for accuracy, completeness, or security. The user is fully responsible for his products and applications using LEMO components.









Crimp Tool:	<a href="#">DPC.91.102.V</a>
Crimp settings:	AWG/Selector = 10-12-14/3-1-1
Positionner:	<a href="#">DCE.91.303.BVCM</a>
Extractor:	<a href="#">DCC.30.35B.LAG</a>
Replacement contact:	FGG.3B.580.ZZC
Spanner wrench:	<a href="#">Socket for torque wrench DCM.65.200.AZ</a>

## Cables

CMN.02.T12.078PGZE		Grey	
CMN.02.T12.078PNZE		Black	
CMN.02.T14.072PGZE		Grey	
CMN.02.T14.072PNZE		Black	
CMN.02.T14.072QGZE	TPR (medical)	Grey	
CMN.02.T14.078PGZE		Grey	
CMN.02.T14.078PNZE			
CMN.02.T18.064UNCU			
CMN.02.T20.047PGZE		Grey	
CMN.02.T20.047PNZE			
CMN.02.T20.048QGZE	TPR (medical)	Grey	
CMN.02.T28.030PGCE	PVC	GREY	
CMN.02.T28.030PGZE		Grey	
CMN.02.T28.030PNCE	PVC	Black	
CMN.02.T28.030PNZE			
102080	PVC	Grey	
120184	PVC	Black	
120240	PVC	Black	
120250	PVC	Grey	
120500	PVC	Grey	
120501	PVC	Grey	
120751	PVC	Grey	
20140	PVC	Grey	
20140	PVC	Grey	
20141	PVC	Grey	
20142	PVC	Red	
20143	PVC	Green	
20144	PVC	Black	
20145	PVC	Yellow	
20146	PVC	Black	

LEMO products and services are provided "as is". LEMO makes no warranties or representations with regard to LEMO product & services or use of them, express, implied or statutory, including for accuracy, completeness, or security. The user is fully responsible for his products and applications using LEMO components.

20240	PTFE	White	
20260	PVC	Black	
20264	PVC	Black	
20266	PVC	Violet	

2050	PVC	Black	
20550	PUR	Black	
20560	PUR	White	
2080	PVC	Grey	
220151	PVC	Grey	
220750	PVC	Grey	
2221	PVC	Black	
2260	PTFE	White	
2280	PVC	Black	
320150	PVC	Grey	
4082	PVC	Grey	
CMB.02.210.635	PUR	Black	

LEMO products and services are provided "as is". LEMO makes no warranties or representations with regard to LEMO product & services or use of them, express, implied or statutory, including for accuracy, completeness, or security. The user is fully responsible for his products and applications using LEMO components.