

Product Description

Description:	76.80MHz GSX-113/X SM Crystal
Product family:	GSX-113
Category:	SM Quartz Crystal
Order code:	MP09847

Features

- ▶ Fundamental mode up to 80.0MHz
- ▶ Ultra-miniature for maximum space saving
- ▶ Compatible with latest ASIC designs

Additional Information

For dimensions, refer to package drawing: **D0382-A**

Electrical Specifications

Parameter	Value	Notes
Nominal frequency:	76.80MHz	
Total frequency tolerance budget:	±20ppm max	
Temperature stability:	-12ppm min, 14ppm max	-40 to +100°C, referred to the value at 25°C
Calibration tolerance:	±4ppm max	@25°C ±3°C
Frequency drift after reflow:	±1ppm max	After 2 reflows
Ageing:	-2ppm min, 0ppm max	Over five years
Frequency perturbations:	±1ppm max	
Operating temperature range:	-40 to +105°C	
Storage temperature range:	-40 to +105°C	
Circuit condition:	9.16pF	
Equivalent series resistance:	10Ω min, 30Ω max	
Spurious mode series resistance:	1100Ω min	
Motional inductance:	1.3mH min, 4.0mH max	
Pullability/sensitivity:	20ppm/pF max	
Drive level:	0.01μW min, 300μW max	
Motional capacitance:	1.2fF min, 2.4fF max	
Static capacitance:	0.3pF min, 1.3pF max	

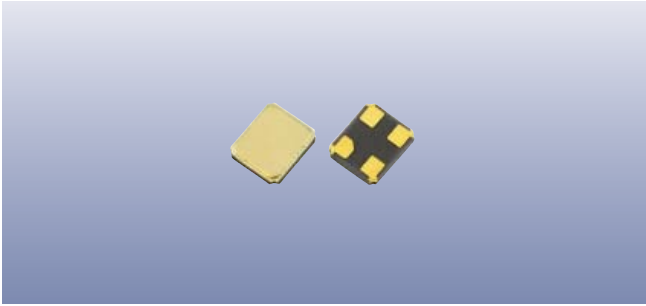

Product Description

Description:	76.80MHz GSX-113/X SM Crystal
Product family:	GSX-113
Category:	SM Quartz Crystal
Order code:	MP09847

Tape & Reel Specification

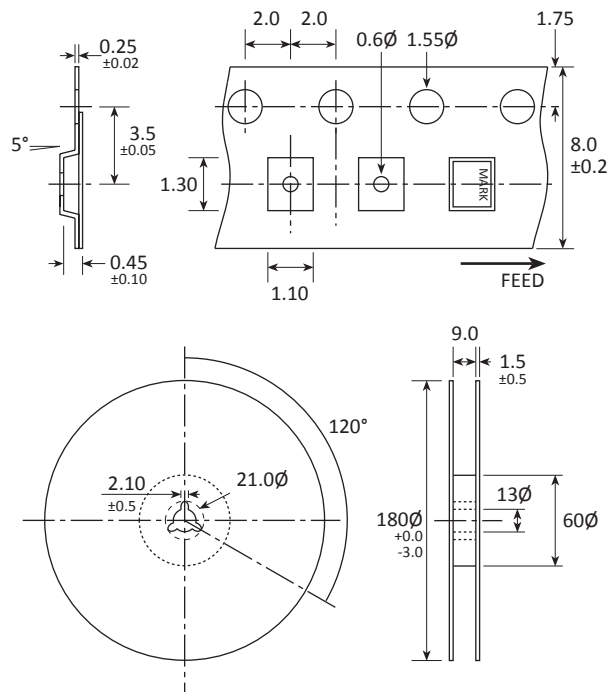

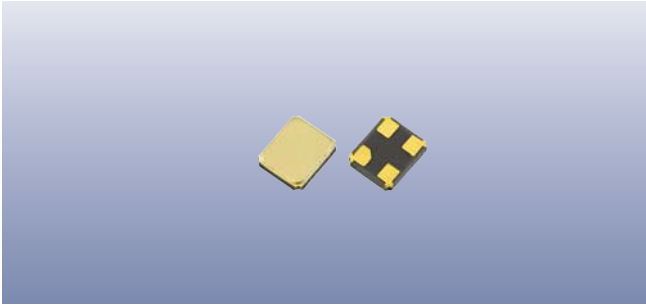

Product Family

GSX-113

Construction

- ▮▮▮▮ Ceramic body with gold-plated pads
- ▮▮▮▮ Metal lid, seam sealed

Dimensions (mm)

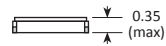
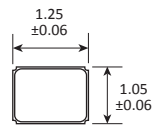

SOLDER PAD LAYOUT

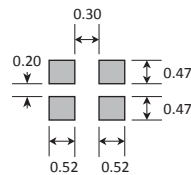
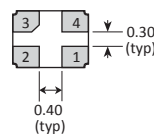

PAD	CONNECTION
1	Crystal
2	Not connected
3	Crystal
4	Ground & lid