

## ALS70A102KF600

Aliases (A390LM102M600A)

ALS70, Aluminum Electrolytic, 1,000 uF, 20%, 600 VDC, -40/+85°C

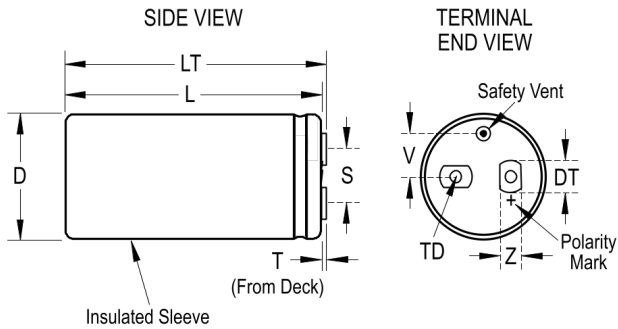

Click [here](#) for the 3D model.

### Dimensions

D	51mm +/-1mm
L	105mm +/-2mm
T	5.5mm +/-0.5mm
S	22.2mm +/-0.5mm
DT	13mm +/-0.5mm
LT	110.5mm +/-1mm
TD	10mm MIN
V	13.7mm NOM
Z	10mm NOM

### Packaging Specifications

Sleeving	Yes
Packaging	Tray

### General Information

Series	ALS70
Dielectric	Aluminum Electrolytic
Description	Screw Terminal, Aluminum Electrolytic
RoHS	Yes
AEC-Q200	No
Halogen Free	Yes
Component Weight	300 g
Notes	Dimensions D And L Include Sleeving. MS (MxH) = M12x16. Mounting Clamp (Sold Separately): V4/2737
Shelf Life	156 Weeks

### Specifications

Capacitance	1,000 uF
Capacitance Tolerance	20%
Voltage DC	600 VDC, 660 VDC (Surge)
Temperature Range	-40/+85°C
Rated Temperature	85°C
Life	18000 Hrs (Rated Voltage And Ripple Current At 85C), 36000 Hrs (Rated Voltage At 85C)
Resistance	136 mOhms (100Hz 20C), 94 mOhms (10kHz 20C)
Ripple Current	7.3 Amps (100Hz 85C), 13.8 Amps (10kHz 85C)
Leakage Current	3600 uA