

Panelboards and Lighting Control

Panelboards



3.1 Introduction	
Product Selection Guide	V2-T3-2
3.2 EZ Box and EZ Trim	
Product Description	V2-T3-4
Features	V2-T3-4
Standards and Certifications	V2-T3-5
Product Selection	V2-T3-6
3.3 Pow-R-Line Xpert Panelboards	
Product Description	V2-T3-7
Application Description	V2-T3-8
Standards and Certifications	V2-T3-10
Power Xpert Release Trip Unit for Molded Case Circuit Breakers	V2-T3-11
Technical Data and Specifications	V2-T3-12
Type PRL1X	V2-T3-18
Type PRL1XF	V2-T3-22
Type PRL1X-LX	V2-T3-25
Type PRL2X	V2-T3-29
Type PRL2XF	V2-T3-33
Type PRL2X-LX	V2-T3-36
Retrofit Panelboard	V2-T3-40
Type PRL3E	V2-T3-48
Type PRL3X	V2-T3-52
Type PRL3XF	V2-T3-56
Type PRL3FQS	V2-T3-59
Type PRL4X	V2-T3-62
Type PRL4DX	V2-T3-72
3.4 Power Xpert Multipoint Meter	
Product Description	V2-T3-82
3.5 Branch Circuit Monitoring (PXBCM) Panelboards	
Product Description	V2-T3-84
3.6 Elevator Control Panelboard	
Elevator Control Panelboard	V2-T3-87
3.7 Types PRL1X, 2X, 3E, 3X, 4X and Column Modifications	
Types PRL1X, 2X, 3E, 3X, 4X, Column	V2-T3-89
Modifications Selection Guide	V2-T3-89
3.8 Pow-R-Command	
Product Overview	V2-T3-98
Features	V2-T3-100
Product Selection	V2-T3-102
Accessories	V2-T3-113
3.9 Metering Service Sections	
Product Description	V2-T3-118
Catalog Number Selection	V2-T3-119
Product Selection	V2-T3-119
3.10 Pow-R-Xpress Program	
Pow-R-Xpress Program	V2-T3-121
3.11 Satellite Operations	
Satellite Operations	V2-T3-122

3.1

Panelboards and Lighting Control

Introduction

Product Selection Guide

Product Types

3



Type PRL1X

Bolt-On or Plug-On Circuit Breakers 240 Vac Maximum

Main lugs only
600 A maximum

Main circuit breaker
600 A maximum

Branch circuit breakers
100 A maximum,
Single-, two- and three-pole



Fusible Lighting Panelboard PRL1XF

240 and 480Y/277 Vac Maximum

Main lugs only
400 A maximum

Branch overcurrent protective devices
30 A maximum,
Single-, two- and three-pole utilizing Class CC fuses



Type PRL1X-LX Column Type

Bolt-On Circuit Breakers 240 Vac Maximum

Main lugs only
225 A maximum

Main circuit breaker
225 A maximum

Branch circuit breakers
100 A maximum,
Single-, two- and three-pole



Type PRL2X

Bolt-On Circuit Breakers 240 or 480Y/277 Vac; 125/250 Vdc Maximum

Main lugs only
600 A maximum

Main circuit breaker
600 A maximum

Branch circuit breakers
100 A maximum,
Single-, two- and three-pole



Fusible Lighting Panelboard PRL2XF

240 and 480Y/277 Vac Maximum

Main lugs only
400 A maximum

Branch overcurrent protective devices
30 A maximum,
Single-, two- and three-pole utilizing Class CC fuses



Type PRL2X-LX, Column Type

Bolt-On Circuit Breakers 240 or 480Y/277 Vac; 125/250 Vdc Maximum

Main lugs only
225 A maximum

Main circuit breaker
225 A maximum

Branch circuit breakers
100 A maximum,
Single-, two- and three-pole

Product Types, continued



Retrofit Panelboard PRL1RX and PRL2RX

Bolt-On Circuit Breakers 480Y/277 Vac; 240 Vac, 480Y/277 Vac

Main lugs only
225 A maximum

Main circuit breaker
225 A maximum

Branch circuit breakers
100 A maximum,
Single-, two- and three-pole



Type PRL3E

Bolt-On Circuit Breakers 240, 480Y/277 or 480 Vac; 250 Vdc Maximum

Main lugs only
600 A maximum

Main circuit breaker
600 A maximum

Branch circuit breakers
125 A maximum,
Single-, two- and three-pole



Type PRL3X

Bolt-On Circuit Breakers 240, 480 or 600 Vac; 250 Vdc Maximum

Main lugs only
800 A maximum

Main circuit breaker
600 A maximum

Branch circuit breakers
225 A maximum,
Single-, two- and three-pole



Type PRL3XF

Bolt-On Fusible Switches 240, 480 or 600 Vac; 125 Vdc Maximum

Main lugs only
400 A maximum

Main fusible or non-fusible switch
400 A maximum

Eaton Bussmann™ Type Compact Circuit Protector Base (CCP2B); Branch Fuses Bussmann TCF or FCF CUBEFuse®

100 A maximum
Single-, two- and three-pole



Type PRL4X

Circuit Breakers or Fusible Switches 240, 480 or 600 Vac; 600 Vdc Maximum

Main lugs only
1200 A maximum

Main circuit breaker
1200 A maximum

Main fusible switch
1200 A maximum

Branch circuit breakers
1200 A maximum,
Single-, two- and three-pole

Branch fusible switches
1200 A maximum,
two- and three-pole

Product Types, continued



Pow-R-Command

Bolt-On Circuit Breakers 240 or 480Y/277 Vac

Main lugs only
400 A maximum

Main circuit breaker
400 A maximum

Branch circuit breakers
225 A maximum,
Single-, two- and three-pole

Single- and two-pole remote
operated circuit breakers

Integral load switching and
dimming controls

Metering Service Section

Bolt-On Circuit Breaker or Fusible Switch 240, 480 or 600 Vac

Service entrance panels combining a
main disconnect with a power
company metering compartment
400–1200 A

Elevator Control Panelboard

Bolt-On Fusible Switches 600 Vac Maximum

Controls for up to four elevators
in a single panelboard

Main lugs only
800 A maximum

Branch overcurrent devices
15–200 A fusible switches with
Class J fuse clips maximum

Designed to meet specific
sections of various codes
impacting elevators

3.2

Panelboards and Lighting Control

EZ Box and EZ Trim

3

Type PRL1X Panelboard



Product Description

Eaton’s EZ Box™ and EZ Trim™ represent the first significant change in panelboard box and trim designs in more than a half-century. The EZ Box and EZ Trim have been designed for faster, more secure and safer installations. They are provided standard for Eaton’s Pow-R-Line™ 1X and Pow-R-Line 2X lighting panelboards, as well as the Pow-R-Line 3a and Pow-R-Line 3E mid-range panelboard.



Flange Detail

Features

- Virtually eliminates sharp edges
- Trim installs in seconds rather than minutes
- Door-in-door is standard
- Ability to adjust flush box to wall irregularities
- Trim installs without the need for tools
- No exposed hardware (because there is none)

The EZ Box flanges are bent and painted, which virtually eliminates the sharp edges associated with traditional boxes. Additionally, all steel panelboard chassis parts are painted. This significantly reduces potential injury for material handlers and installers. Each flange is adjustable outward up to 3/4-inch (19.1 mm). This feature allows the installer to adjust flush box applications to be level and flat with the finished wall after the wall material is installed to help correct wall irregularities. The new box flange also provides the means for attaching the EZ Trim.

Contents

Description

EZ Box and EZ Trim

Standards and Certifications	V2-T3-5
Product Selection	V2-T3-6

Page

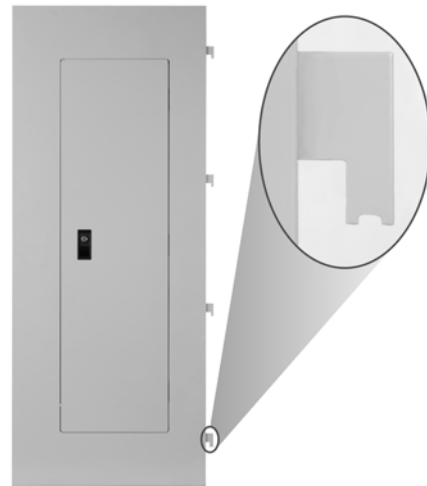

Standalone Trim and Bottom Flange Hanger with Notch



Corner Flange Detail

Fast Installation

The EZ Trim incorporates a groundbreaking design that installs in seconds, rather than minutes. The standard trim features include: door-in-door construction, no exposed hardware and requires no tools for installation.

Each EZ Trim includes hangers attached on the right side. The bottom trim hanger has a notch in its base. To install, the bottom hanger is inserted into the bottom right side box flange opening, resting the notch on the flange.



Trim Hanger Inserted Into Box Flange

The balance of the hangers are aligned with the other flange openings and pushed in. When all hangers are in the box flange, the trim is lifted up slightly to clear the notch on the bottom hanger, and the trim is self-supported on the EZ Box.

The installation is completed by swinging the trim to the closed position, then lifting and pushing slightly to the right. The trim will drop into place totally secured. The multi-point catches on the left side of the trim will lock into the left side box flange openings.

To prevent the trim from being removed by non-authorized persons, a unique sliding means automatically latches in place when the trim door is closed. Along with a new lock, the EZ Trim offers a high degree of door security.

See complete [installation instructions](#) for details.

Standards and Certifications

When used with Eaton's panelboard chassis, EZ Boxes and EZ Trims meet the following applicable industry standards:

- UL® 50 listed
- NEMA® Standard PB1
- Federal specifications
- National Electrical Code®



Trim Hanging on Surface Mounted Box

3.2

Panelboards and Lighting Control

EZ Box and EZ Trim

Product Selection

Boxes and Trims Only—Type 1

3

Types PRL1X, PRL2X

Box Dimensions—Inches (mm)	Height	YS Box Catalog Number	LT Trim Catalog Number	EZ Box ① Catalog Number	EZ Trim ① Catalog Number
20.00 W x 5.75 D (508.0 W x 146.1 D)	36.00 (914.4)	YS2036	LT2036S or F	EZB2036R	EZT2036S or F
	42.00 (1066.8)	YS2042	LT2042S or F	EZB2042R	EZT2042S or F
	48.00 (1219.2)	YS2048	LT2048S or F	EZB2048R	EZT2048S or F
	60.00 (1524.0)	YS2060	LT2060S or F	EZB2060R	EZT2060S or F
	72.00 (1828.8)	YS2072	LT2072S or F	EZB2072R	EZT2072S or F
	90.00 (2286.0)	YS2090	LT2090S or F	EZB2090R	EZT2090S or F

Type PRL3X

Box Dimensions—Inches (mm)	Height	YS Box Catalog Number	LT Trim Catalog Number	EZ Box ① Catalog Number	EZ Trim ① Catalog Number
20.00 W x 5.75 D (508.0 W x 146.1 D)	36.00 (914.4)	YS2036	LTV2036S or F	EZB2036R	EZTV2036S or F
	48.00 (1219.2)	YS2048	LTV2048S or F	EZB2048R	EZTV2048S or F
	60.00 (1524.0)	YS2060	LTV2060S or F	EZB2060R	EZTV2060S or F
	72.00 (1828.8)	YS2072	LTV2072S or F	EZB2072R	EZTV2072S or F
	90.00 (2286.0)	YS2090	LTV2090S or F	EZB2090R	EZTV2090S or F

Type PRL3X (800 A)

Box Dimensions—Inches (mm)	Height	YS Box Catalog Number	LT Trim Catalog Number	EZ Box ① Catalog Number	EZ Trim ① Catalog Number
28.00 W x 5.75 D	36.00 (914.4)	YS2836	LTV2836S or F	EZB2836R	EZTV2836S or F
	48.00 (1219.2)	YS2848	LTV2848S or F	EZB2848R	EZTV2848S or F
	60.00 (1524.0)	YS2860	LTV2860S or F	EZB2860R	EZTV2860S or F
	72.00 (1828.8)	YS2872	LTV2872S or F	EZB2872R	EZTV2872S or F
	90.00 (2286.0)	YS2890	LTV2890S or F	EZB2890R	EZTV2890S or F

Note

① EZ Box must be used with EZ Trim.

Pow-R-Line Xpert Panelboards



Contents

Description	Page
Application Description	V2-T3-8
Standards and Certifications	V2-T3-10
Power Xpert Release Trip Unit for Molded Case Circuit Breakers	V2-T3-11
Technical Data and Specifications	V2-T3-12
Type PRL1X	V2-T3-18
Type PRL1XF	V2-T3-22
Type PRL1X-LX	V2-T3-25
Type PRL2X	V2-T3-29
Type PRL2XF	V2-T3-33
Type PRL2X-LX	V2-T3-36
Retrofit Panelboard	V2-T3-40
Type PRL3E	V2-T3-48
Type PRL3X	V2-T3-52
Type PRL3XF	V2-T3-56
Type PRL3FQS	V2-T3-59
Type PRL4X	V2-T3-62
Type PRL4DX	V2-T3-72

Product Description

Lighting and Distribution Panelboards

Eaton’s assembled panelboards are designed for sequence phase connection of branch circuit devices. This allows complete flexibility of circuit arrangement (single-, two- or three-pole) to allow balance of the electrical load on each phase.

Sturdy, rigid chassis assembly ensures accurate alignment of interior with panel front. This prevents flexing and minimizes possibility of loosening or damage to current carrying parts during and after installation.

Four-point in-and-out adjustment of panel interior is provided to meet critical depth dimensions on flush installations. This compensates for possible misalignment of box at installation.

Main lugs are mechanical solderless type and approved for copper or aluminum conductors.

Enclosures

Boxes are code-gauge galvanized steel, which include a painted box finished in ANSI-61 light gray to match the trim.

Standard panelboard cabinets are designed for indoor use. Alternate types are available for indoor and special purpose applications.

All enclosures are furnished in accordance with Underwriters Laboratories standards and include wiring gutters with proper wire bending space. Special cabinets can be provided at an additional charge.

The box dimensions shown are inside dimensions. For outside dimensions, add 1/4-inch (6.4 mm).

Standard panelboard boxes are supplied without knockouts (blank endwalls).

Fronts

Fronts (trims) for all panelboards are made of code-gauge steel and have a high durability ANSI-61 light gray finish applied by a baked-on polyester powder coating paint system.

The fronts for lighting and appliance branch circuit panelboards and small power distribution panelboards include a door with rounded corners and concealed hinges. A flush-type latch and lock assembly is included. All locks are keyed alike. The trims are available in both surface- and flush-mounted designs.



The Three-Piece Trim for Larger Power Distribution Panelboards Provides for Easy Handling and Installation

Fronts for power distribution panelboards utilize a unique breaker front cover design in which each device has a dedicated bolt-on steel cover. The individual covers form a single deadfront for the panelboard that is used in conjunction with two wiring gutter covers to complete the trim. A door is not included as part of the standard offering, but can be provided at an additional cost. A deeper than standard box is also required.



EZ Trim Features Standard Door-in-Door with No Exposed Hardware or Sharp Edges (no Tools are Required for Installation)

Application Description

Panelboard Selection Factors

In selecting a panelboard, the following factors must be considered:

- Service (voltage and frequency)
- Interrupting capacity (fully or series rated)
- Ampere rating of main
- Ampere ratings of branches
- Environment

Panelboard Short-Circuit Rating

The short-circuit rating of Eaton's assembled panelboards are test verified by, and listed with, Underwriters Laboratories (UL). Generally, these ratings are that of the lowest interrupting rated device in the panel.

Certain exceptions to this rule exist where branch devices have been UL tested in combination with specific main devices having a higher interrupting rating. Where these defined main devices and branch breaker combinations are utilized, the series short-circuit rating of the assembled panelboard will be the same as the tested rating of the approved rated main device in series with the branches.

Series Rating Combinations

For more information on product series ratings, please refer to the Eaton website at <https://www.eaton.com/us/en-us/products/low-voltage-power-distribution-control-systems/series-rating.html> or download Eaton Information Manual 1C96944H02.

These series ratings apply to panels having main devices, or main-lug-only panelboards fed remotely by the device listed in the series ratings chart as the main, for which UL listed tests were conducted.

Service Entrance Equipment

Service Entrance Equipment NEC Articles 230.62 and 230.71, and UL, require that:

- Panelboards used as service entrance equipment must be located near the point where the supply conductors enter the building
- A single service disconnect within the panelboard
- Must include service disconnect barrier, connector for bonding and grounding neutral conductor
- A service-entrance-type UL label must be factory installed
- Ground fault protection of equipment shall be provided for solidly grounded wye electrical services of more than 150 V to ground, but not exceeding 600 V phase-to-phase for each service disconnecting means rated 1000 A or more
- Service entrance panels must be identified as such on the order entry to the manufacturing location

Panelboard Standards

In 2008, both the National Electrical Code (Article 408) and UL 67 were updated to remove the mandated 42-circuit limitation. Eaton offers panelboards with more than 42 circuits for those jurisdictions that have adopted the 2008 NEC or later.

For jurisdictions that have not adopted the 2008 or later version of the National Electrical Code, the 42-circuit limitation for Lighting and Appliance Branch Panelboards remains in place. Check with your local code officials to determine specific jurisdiction status.

Panelboard Installation

NEC requires that the operating handle of the topmost mounted device be no more than 6 feet 7 inches (2006.6 mm) above the finished floor and should be installed per NEC and manufacturer's instructions.

Additional boxes and fronts are required when the components required for one panelboard exceed the standard box dimensions.

Multi-Section Panelboards

When two or more separate enclosures are required, separate fronts for each box are standard. A common front can be furnished at additional charge.

Interconnecting Multi-Section Panelboards

When a panelboard, for connection to one feeder, must be furnished in more than one section (Box), each section must be furnished with main bus and terminals of the same rating, unless a main overcurrent device is provided in each section.

Sub-feed or through-feed provisions must also be included (and priced) to provide connection capability to the second section.

Note: Sub-feed or through-feed lugs cannot be used on any panelboard that is not protected by a single main overcurrent device either in the panelboard or immediately upstream, i.e., service entrance panelboards with main lugs only using the six disconnect rule.

Service Entrance Main Breaker Kits

Description	Circuit Breaker Frame	Catalog Number
Service entrance barrier for PD5	PD5	PRLSEBPD5
Service entrance barrier for PD4	PD4	PRLSEBPD4
Service entrance barrier for PD3	PD3	PRLSEBPD3
Service entrance barrier for PD2	PD2	PRLSEBPD2
Service entrance barrier for GHB	GHB	PRLSEBGHB
Service entrance barrier for BAB	BAB	PRLSEBBAB

Sub-Feed Lugs

Sub-feed lugs (see figure below) are one means of interconnecting multi-section panels. The sub-feed (second set of) lugs are mounted directly beside the main lugs. These are required in each section except the last panel in the lineup. The feeder cables are brought into the wiring gutter of the first section and connected to the main lugs. Another set of the same size cables are connected to the sub-feed lugs (Section 1) and are carried over to the main lugs of the adjacent panel. Cross connection cables are not furnished by Eaton. Sub-feed lugs are only available on main-lug-only panels.

Note: Sub-feed lugs may not be used on main-lug-only (six disconnect rule) service entrance panels.

Sub-Feed Lugs

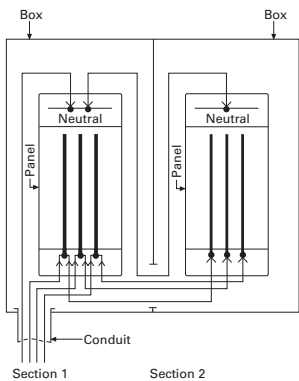

Through-Feed Lugs

Through-feed lugs (see figure below) are another method to interconnect multi-section panelboards. The incoming feeder cables are connected to the main lugs or main breaker at the bottom of panel (Section 1). Another set of lugs (through-feed) are located at the opposite end of the main bus. The interconnecting cables are connected to the through-feed lugs in Section 1 and are carried over to the main lugs in Section 2. The connection arrangement could be reversed, i.e., main lugs at top; through-feed lugs at bottom end of panel. Cross cables are not furnished by Eaton.

Note: Through-feed lugs may not be used on main-lug-only (six disconnect rule) service entrance panels.

Through-Feed Lugs

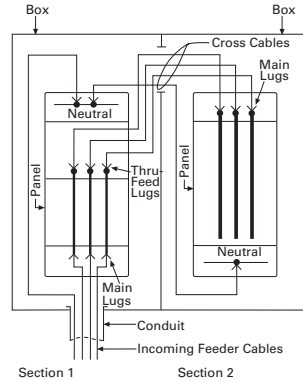

Multiple Section Panelboard—Flush Mounted

Shown below is the standard method for flush mounting multiple section lighting and distribution panelboards using standard flush trims.

Multiple Section Panelboard Flush Mounted—Dimensions in Inches (mm)

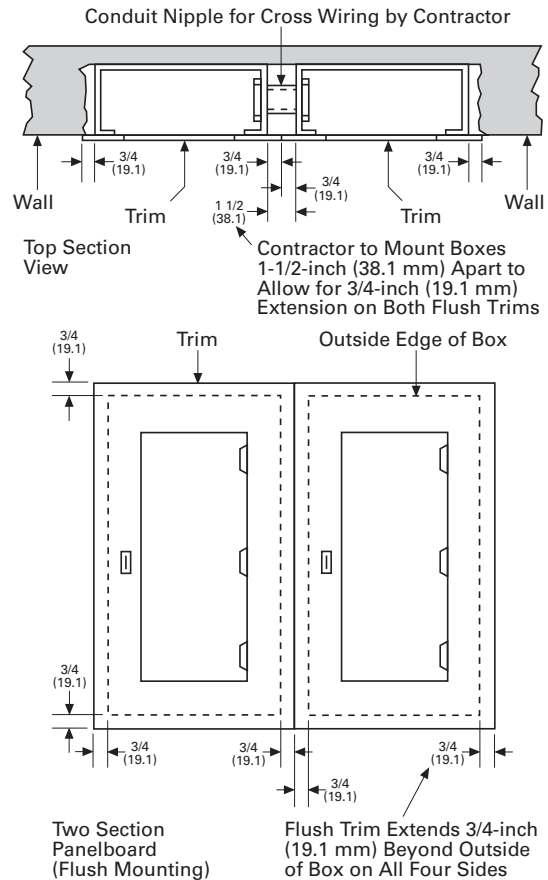

Overcurrent Protection

The following requirements will be found in the NEC:

Each lighting and appliance branch circuit panelboard shall be individually protected on the supply side by not more than two main circuit breakers or two sets of fuses having a combined rating not greater than that on the panelboard.

Branch Circuit Loading for Lighting Panels

The size of mains and branches should be selected based on the following:

- Motor circuits: NEC Article 430
- Diversity factor
- Provision for future loading

Exception Number 1:

Individual protection for a lighting panelboard is not required when the panelboard feeder has overcurrent protection not greater than that of the panelboard.

Exception Number 2:

For existing installations, individual protection for lighting panelboards is not required where such panelboards are used as service equipment in supplying an individual residential occupancy and where any bus supplying 15 or 20 A circuits is protected on the supply side by an overcurrent device.

Ambient Temperatures

The primary function of an overcurrent device is to protect the conductor and its insulation against overheating. In selecting the size of the devices and conductors, consideration should be given to the ambient temperature surrounding the conductors within and external to the panelboard. Cumulative heating within the panelboard may cause premature operation of the overcurrent protective devices.

Underwriters Laboratories test procedures are based, in part, on 80% loading of panelboard branch circuit devices. The NEC limits the loading of overcurrent devices in panelboards to 80% of rating where in normal operation the load will continue for three hours or more. Further derating may be required, depending on such factors as ambient temperature, duty cycle, frequency or altitude.

Exception: There is one exception to this rule in both UL and NEC. It applies to assemblies and overcurrent devices that have been listed for continuous duty at 100% of its rating.

Special Conditions

Standard panelboards, assembled with standard components, are adequate for most applications. However, special consideration should be given to those required for application under special conditions such as:

- Excessive vibration or shock
- Frequencies above 60 cycles
- Altitudes above 6600 feet (2011.7 m)
- Damp environment (possible fungus growth)
- Compliance with federal, state and municipal electrical codes and standards

Seismic Considerations

The Uniform Building Code® and the International Building Code®, as well as local and state building codes, place an emphasis on seismic building design requirements. Electrical distribution systems are treated as attachments to the building and therefore, fall into this category.

All Eaton panelboards are seismic qualified at the highest possible level, and have been tested in accordance with ANSI C37.81. This standard quantifies actual earthquake conditions, as well as equipment seismic capability.



Harmonic Currents

Standard panelboard neutrals are rated for 100% of the panelboard current. However, since harmonic currents can cause overheated neutrals, an option is provided for neutrals to be rated at 200% (1200 A maximum neutral for 600 A main bus) of the panelboard phase current.

Panelboards with the 200% rated neutral are UL listed as suitable for use with non-linear loads.

Prior to specifying the 200% rated neutral, Eaton recommends a harmonic survey be conducted of the distribution system, be it new or existing.

Surge Protective Devices

The quality of power feeding sensitive electronic loads is critical to the reliable operation of any facility. In modern offices, hospitals, and manufacturing facilities, the most frequent causes of microprocessor-based equipment downtime and damage are voltage transients and electrical noise.

Electrical loads and microprocessor-based equipment are highly susceptible to both high and low energy transients. High energy transients include lightning induced surges and power company switching. These high energy transients can destroy components instantly.

More frequently the electrical system experiences low energy transients and high frequency noise.

The effects of continual low energy transients and high frequency noise can cause erratic equipment performance or sudden failure of electronic circuit board components.

Eaton can provide protective and diagnostic systems integral to panelboards. The surge protective device (SPD) is integrated into the panelboards using a “zero lead length” direct bus bar connection.



Eaton SPDs May be Integrated into Most Panelboards

The SPD protects sensitive electronic equipment from the damaging effects of high and low energy transients, as well as high frequency noise.

Standards and Certifications

Eaton’s panelboards are designed to meet the following applicable industry standards, except where noted:

- Underwriters Laboratories:
 - Panelboards: UL 67
 - Cabinets and boxes: UL 50
 - CSA® C22.2 No. 29

Note: Only panelboards containing UL listed devices can be UL labeled.

- National Electrical Code
- NEMA Standards: PB 1
- Federal Specification W-P-115c:
 - Circuit breakers—Type I Class I
 - Fusible switches—Type II Class I



Power Xpert Release Trip Unit for Molded Case Circuit Breakers

Description

Eaton's Power Xpert Release (PXR) trip units are programmable communicating microprocessor-based low-voltage electronic trip unit systems for Eaton molded case circuit breakers. PXR trip units are available in three models: PXR 10, PXR 20 and PXR 25.

Standards and Certifications

The PXR trip units are listed by Underwriters Laboratories (UL) and Canadian Standards Association (CSA) for use in Power Defense™ Frame 2, 3, 4, 5 and 6 molded case circuit breakers. All PXR units have also passed the IEC 60947-2 test program that includes EMC testing. All trip units meet the low-voltage and EMC directives and carry the CE mark.

Features

The PXR electronic trip units provide an enhanced and easy-to-use interface that enables end users and maintenance engineers to more easily change set points, test and configure circuit breakers, and review energy and power information. The Power Xpert Protection Manager (PXPM) software also provides the capability of secondary injection tests and reports on-demand without the need of expensive test kits.

Advanced features include:

- Industry-first breaker health algorithms provide real-time monitoring and communication of breaker condition
- Cause of trip LED indication and trip event data storage
- Zone selective interlocking (ZSI) verification and testing indication
- Adjustable Arcflash Reduction Maintenance System™ settings
- LCD display with programmable settings

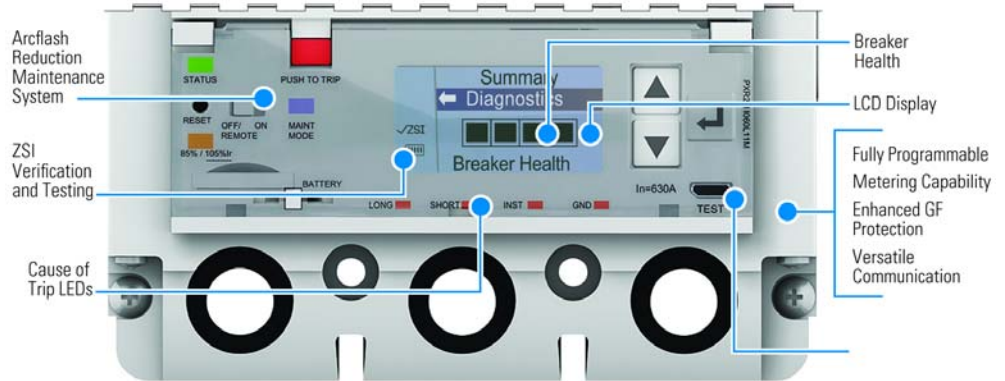

PXR 25 Trip Unit

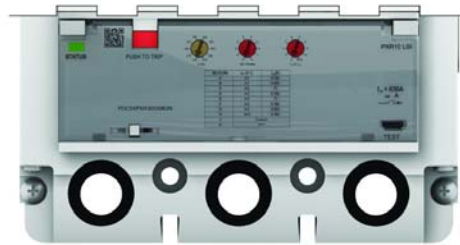

PXR 10

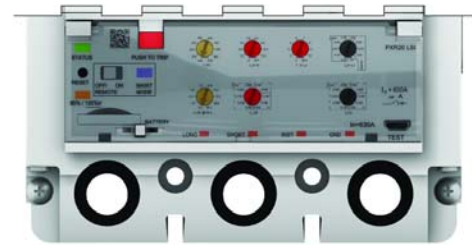

PXR 20

PXR Features

Features	PXR 10	PXR 20	PXR 25
Protection types	LSI	LSI/LSIG	LSI/LSIG
Status indication	●	●	●
USB secondary injection testing	●	●	●
Programmable by USB port (PXPM)	●	●	●
Independent instantaneous adjustment	●	●	●
Adjustable L, S, I, G pickup and time		●	●
Cause of trip indication	▲	●	●
Load alarm indication with 2 levels		●	●
Programmable load alarm levels			●
Ground fault protection and alarm		○	○
Arcflash Reduction Maintenance System Available PD3, PD4, PD5, PD6 to meet NEC 240.87 requirements		○	○
Zone selective interlocking (ZSI) with indication		○	○
Programmable relays		○	●
Modbus RTU communication		○	●
CAM module communication		○	○
Rotatable LCD display			●
Breaker health and diagnostic monitoring		▲	●
Current metering accuracy		2.0%	0.5%
Voltage metering accuracy			0.5%
Power and energy metering accuracy			1.0%

Legend:
 ● Standard
 ○ Optional
 ▲ Available through USB port (PXPM)

Technical Data and Specifications

Panelboard Selection Guide

Panelboard Type	Device Type	Maximum Voltage Rating		Maximum Main Rating (Amperes)		Branch Circuits Ampere Range	Sub-Feed Breaker Maximum Amperes	AC Interrupting Capacity rms Symmetrical Amperes (kA)	
		AC	DC	MLO	Main Device			Fully Rated	Series Rated
PRL1X	Breaker	240	—	600	600	15–100	600	10–22	22–100
PRL1R	Breaker	240	—	225	225	15–100	—	10–22	22–100
PRL1XF	Fusible	240	—	400	400	15–30	400	200	—
PRL1X-LX	Breaker	240	—	225	225	15–100	—	10–22	22–100
PRL2X	Breaker	240	250	600	600	15–100	600	65	65–200
	Breaker	480Y/277	250	600	600	15–100	600	14	22–150
PRL2RX	Breaker	240	—	225	225	15–100	—	10–22	22–200
	Breaker	480Y/277	—	225	225	15–100	—	14	22–100
PRL2XF	Fusible	480Y/277	—	400	400	15–30	400	200	—
PRL2X-LX	Breaker	240	250	225	225	15–100	—	65	65–200
	Breaker	480Y/277	250	225	225	15–100	—	14	22–150
PRL3E	Breaker	240	250	600	600	15–125	400	25–100	100–200
	Breaker	480Y/277	250	600	600	15–125	400	18–65	65–100
	Breaker	480	250	600	600	15–125	400	18–65	65–100
PRL3X	Breaker	240	250	800	600	15–225	600	10–200	22–200
	Breaker	480	250	800	600	15–225	600	14–100	22–150
	Breaker	600	250	800	600	15–225	600	14–35	—
PRL3XF	Fusible	240	250	400	400	1–100	—	50–200	—
	Fusible	600	250	400	400	1–100	—	50–200	—
PRL4X	Breaker	240	600	1200	1200	15–1200	—	10–200	22–200
	Breaker	480	600	1200	1200	15–1200	—	14–200	22–150
	Breaker	600	600	1200	1200	15–1200	—	14–200	—
PRL4DX	Breaker	240	—	1200	1200 ^①	600	—	65–200	—
	Breaker	480	—	1200	1200 ^①	600	—	35–100	—
	Breaker	600	—	1200	1200 ^①	600	—	18–50	—
PRL4F	Fusible	240	250	1200	1200	30–1200	—	100–200	—
	Fusible	600	250	1200	1200	30–1200	—	100–200	—
Pow-R-Command™	Breaker	240	—	400	400	15–225	—	10–65	22–100
	Breaker	480Y/277	—	400	400	15–225	—	14	65–100
Elevator Control	Fusible	240	—	800	800	15–200	—	200	—
	Fusible	480Y/277	—	800	800	15–200	—	200	—
	Fusible	480	—	800	800	15–200	—	200	—

Note

① Fixed mounted only.

Terminal Wire Ranges, Pressure-Type Al/Cu Terminals Except as Noted

Note: All terminal sizes are based on wire ampacities corresponding to those shown in NEC Table 310.16 under the 75 °C insulation columns (75 °C wire). The use of smaller size, (in circular mills), regardless of insulation temperature rating, is not permitted.

Where copper-aluminum terminals are supplied on designated panelboard types, best results are obtained if a suitable joint compound is applied when aluminum conductors are used.

Check Eaton’s standard terminal sizes versus customer requirements. In particular, 400 A and 800 A breakers often require nonstandard lugs.

Optional 750 kcmil mechanical screw-type terminals are available upon request. Panelboard dimensions may be affected, refer to Eaton.

Standard Main Lug Terminals

Panel Type	Wire Size Ranges for Ampere Capacity						
	100 A	225 A	250 A	400 A	600 A	800 A	1200 A
PRL1X	#12–1/0	#6–300 kcmil	—	(2) #4–500 kcmil	(2) 4/0–500 kcmil	—	—
PRL2X	#12–1/0	#6–300 kcmil	—	(2) #4–500 kcmil	(2) 4/0–500 kcmil	—	—
PRL1RX	#12–1/0	#6–300 kcmil	—	(2) #4–500 kcmil	—	—	—
PRL2RX	#12–1/0	#6–300 kcmil	—	(2) #4–500 kcmil	—	—	—
PRL1XF	#12–1/0	#6–300 kcmil	—	(2) #4–500 kcmil	—	—	—
PRL2XF	#12–1/0	#6–300 kcmil	—	(2) #4–500 kcmil	—	—	—
PRL3E	#12–1/0	—	#6–350 kcmil	(2) #4–500 kcmil	(2) #4–500 kcmil	—	—
PRL3X	#12–1/0	—	#6–350 kcmil	(2) #4–500 kcmil	(2) #4–500 kcmil	(3) #4–500 kcmil	—
PRL3XF	#12–1/0	—	#6–350 kcmil	(2) #4–500 kcmil	—	—	—
PRL4X	—	—	#4–500 kcmil	(2) #4–500 kcmil	(2) #4–500 kcmil	(3) #4–500 kcmil	(4) #4–500 kcmil
PRL1X-LX	#12–1/0	#6–300 kcmil	—	—	—	—	—
PRL2X-LX	#12–1/0	#6–300 kcmil	—	—	—	—	—
PRCE	#12–1/0	#6–300 kcmil	—	(2) #4–500 kcmil	—	—	—
PRC100	#12–1/0	—	#6–350 kcmil	(2) #4–500 kcmil	—	—	—
PRC25	#12–1/0	#6–300 kcmil	—	(2) #4–500 kcmil	—	—	—
Elevator Control	—	—	#4–500 kcmil	(2) #4/0–500 kcmil	(2) #4/0–500 kcmil	(3) #4/0–500 kcmil	—

Pow-R-Line Xpert Panelboards

Standard Circuit Breaker Terminals

Breaker Type	Ampere Rating	Wire Range
BAB, QBHW, BABRSP, HQP, QPHW	15–70	#14–#4
	90–100	#8–1/0
PDD2xF, PDD2xG, PDD2xM	100–225	#4–4/0 or #6–300 kcmil
EGB, EGE, EGS, EGH	15–50	#14–3/0 AL/CU
	60–125	#6–3/0 AL/CU
PDG2xF, PDG2xG, PDG2xM, PDG2xP, HFDDC ①	15–100	#14–1/0
	125–225	#4–4/0
FCL	15–100	#14–1/0
GHB, HGHB, GHQ, GHQRSP	15–30	#14–#10
	25–100	#10–1/0
EGB, EGS, EGH	15–50	#14–1/0
	60–125	#6–2/0
HJDDC ①	70–250	#4–350 kcmil
PDD3xG	250–350	250–500 kcmil
	400	(2) 3/0–250 kcmil or (1) 3/0–500 kcmil
PDG3xG ②, PDG3xM ②, PDG3xP ②, HKDDC ①, PDF3xG, PDF3xM	225	(1) #3–350 kcmil
	350	(2) 3/0–250 kcmil or
	400	(2) 3/0–250 kcmil or (1) 3/0–500 kcmil
LHH	150–400	#2–500 kcmil
	150–400	(2) #2–500 kcmil
	150–400	(1) 500–750 kcmil
PDG3xG ②, PDG3xM ②, PDG3xP ②	250–600	(1) #2–500 kcmil
LHH ③	500–600	(2) #2–500 kcmil
CLD	300–500	(2) 250–350 kcmil
	600	(2) 400–500 kcmil
PDG4xG, PDG4xM, HMDLDC ① PDF4xG, PDF4xM	400–600	(2) #1–500 kcmil
	700–800	(3) 3/0–400 kcmil
PDG5xM, CND, PDG5xP	800–1000	(3) 3/0–400 kcmil
	1200	(4) 4/0–500 kcmil
FB-P	15–100	#14–1/0
LA-P	70–225	#6–350 kcmil
	250–400	(1) #4–250 kcmil and (1) 3/0–600 kcmil
NB-P, NBDC ①	300–700	(2) #1–500 kcmil
	800	(3) 3/0–400 kcmil
NGS, PDG5xM, PDG5xP, NGS-C, PDF5xM, PDF5xP	400–1200	(4) 4/0–500 kcmil (Cu/Al)

Notes

- ① Suitable for DC applications only.
- ② The 400 A frame must use trip units of ratings 100–400, while the 600 A frame must use trip units of ratings 500, 600 or designated by H, such as H250. The H as the leading character of the ampacity indicates a high instantaneous version of the breaker for coordination purposes. H ratings must use 600 A frame.
- ③ LHH is 400 A maximum.

FDPW Switch Terminals

Ampere Rating	Wire Range
30	#14–1/0
60	#14–1/0
100	#14–1/0
200	#4–300 kcmil
400	250–750 kcmil or (2) 3/0–250 kcmil
600	(2) #4–600 kcmil or (4) 3/0–250 kcmil
800	(3) 250–750 kcmil or (6) 3/0–250 kcmil
1200	(4) 250–750 kcmil or (8) 3/0–250 kcmil

Elevator Control Panel Feeder Terminals

Ampere Rating	Wire Range
30	#14–1/0
60	#14–1/0
100	#14–1/0
200	#4–300 kcmil

Selection Guide

Molded Case Circuit Breaker Ratings

Note: Circuit breakers equal or exceed Federal Specification W-C-375b requirements for the particular class associated with each circuit breaker type.

Breaker Type	Continuous Ampere Rating	Number of Poles	Maximum Voltage AC	UL Listed Interrupting Ratings—kA Symmetrical Amperes					DC Rating Volts ①	
				AC Rating Volts 120/240	240	277	480	600	125	250
BAB ②③, HQP ②③	15-70	1	120	10	—	—	—	—	—	—
	15-100	2	120/240	10	—	—	—	—	—	—
	15-100	2, 3	240	—	10	—	—	—	—	—
BABRP, BABRSP ②	15-30	1	120	10	—	—	—	—	—	—
	15-30	2	120/240	10	—	—	—	—	—	—
QBGF, QBGFEP, QPGF, QPGFEP, QBAF, QBAG	15-40	1	120	10	—	—	—	—	—	—
	15-50	2	120/240	10	—	—	—	—	—	—
	15-20	1	120	10	—	—	—	—	—	—
	15-20	2	120/240	10	—	—	—	—	—	—
QBHW ②③, QPHW ②③	15-70	1	120	22	—	—	—	—	—	—
	15-100	2	120/240	22	—	—	—	—	—	—
	15-100	2, 3	240	—	22	—	—	—	—	—
QBHGF, QBHGFEP, QPHGF, QPHGFEP	15-30	1	120	22	—	—	—	—	—	—
	15-30	2	120/240	22	—	—	—	—	—	—
GQ, GHQ ②, GHQRD, GHQRSP, GHB ②③	15-30	1, 2	277	65	—	14	—	—	—	—
	15-100 ④	1	277	65	—	14	—	—	14	—
	15-100 ④	2, 3	480Y/277	—	65	—	14	—	—	14
HGHB ②, GHBGFEP	15-30	1	277	65	—	25	—	—	—	—
	15-60	1	277	—	—	14	—	—	—	—
PDG2xF ②③	15-100	1	277	—	—	25	—	—	10	—
	15-100	2, 3	480	—	35	—	25	—	—	10
EGB	15-125	1	277	35	35	18	—	—	10	—
	15-125	2, 3	480	—	35	—	18	—	—	10
EGS	15-125	1	277	100	—	35	—	—	35	—
	15-125	2, 3	480	—	100	—	35	—	—	35
EGH	15-125	1	277	200	—	65	—	—	42	—
	15-125	2, 3	480	—	200	—	65	—	—	42
PDG2xG ②③	15-150	2, 3	600	—	65	—	35	18	—	10
	15-150	1	277	—	—	35	—	—	10	—
	15-225	2, 3	600	—	65	—	35	18	—	10
PDG2xM ②③	15-150	1	277	—	—	65	—	—	10	—
	15-225	2, 3	600	—	100	—	65	25	—	22

Notes

- ① DC ratings apply to substantially non-inductive circuits.
- ② 15 and 20 A single-pole switching duty rated for fluorescent applications.
- ③ Single-, two- and three-pole HACR rated.
- ④ DC rated single-pole, 15-70 A only.

Selection Guide, continued

Molded Case Circuit Breaker Ratings, continued

Note: Circuit breakers equal or exceed Federal Specification W-C-375b requirements for the particular class associated with each circuit breaker type.

Breaker Type	Continuous Ampere Rating	Number of Poles	Volts AC	UL Listed Interrupting Ratings—kA Symmetrical Amperes					DC Rating Volts ^①	
				AC Rating Volts 120/240	240	277	480	600	125	250
PDG2xP ^②	15–225	2, 3	600	—	200	—	100	35	—	22
FCL	15–100	2, 3	480	—	200	—	150	—	—	—
PDD2xF ^②	100–225	2, 3	240	—	22	—	—	—	10	—
PDD2xG ^②	100–225	2, 3	240	—	65	—	—	—	10	—
PDD2xM ^②	100–225	2, 3	240	—	100	—	—	—	10	—
PDD2xP ^②	100–225	2, 3	240	—	200	—	—	—	10	—
EGB ^②	15–125	1, 2, 3	240	—	25	—	18	—	—	—
EGE ^②	15–125	1, 2, 3	240	—	—	—	—	18	—	—
EGS ^②	15–125	1, 2, 3	240	—	85	—	35	22	—	—
EGH ^②	15–125	1, 2, 3	240	—	100	—	65	25	—	—
PDD3xG	250–400	2, 3	240	—	65	—	—	—	—	10
PDG3xG ^⑦ , PDF3xG ^{③⑦}	100–400	2, 3	600	—	65	—	35	18	—	10 ^④
PDG3xM ^⑦ , PDF3xM ^③	100–400	2, 3	600	—	100	—	65	35	—	22 ^④
LHH ^⑤	150–400	2, 3	480	—	100	—	65	35	—	42
PDG3xP ^⑦	100–400	2, 3	600	—	200	—	100	65	—	22 ^④
PDG3xG ^⑦	250–600	3	600	—	65	—	35	18	—	22
PDG3xP ^{⑤⑦}	250–600	2, 3	600	—	200	—	100	50	—	42
CLD ^{③⑤}	300–600	2, 3	600	—	65	—	35	25	—	22 ^④
PDG3xM ^⑦	250–600	3	600	—	100	—	65	35	—	22
PDG4xG ^⑤ , PDF4xG ^{③⑤}	400–800	2, 3	600	—	65	—	50	25	—	22 ^④
PDG4xM ^⑤ , PDF4xM ^{③⑤}	400–800	2, 3	600	—	100	—	65	35	—	25 ^④
CND ^{③⑤}	600–1200	2, 3	600	—	65	—	50	25	—	—
PDG5xM ^⑤	600–1200	2, 3	600	—	100	—	65	35	—	—
PDG5xP ^⑤	600–1200	2, 3	600	—	200	—	100	65	—	—
PDG5xK, PDF5xK	400–1200	2, 3	600	—	85	—	50	25	—	—
PDG5xM, CNGH	400–1200	2, 3	600	—	100	—	65	35	—	—
PDG5xP, CNGC	400–1200	2, 3	600	—	200	—	100	65	—	—
Integrally Fused, Current Limiting Circuit Breakers										
FB-P	15–100	2, 3	600	—	200	—	200	200	—	⑥
LA-P	70–400	2, 3	600	—	200	—	200	200	—	⑥
NB-P	300–800	2, 3	600	—	200	—	200	200	—	⑥

Notes

① DC ratings apply to substantially non-inductive circuits.

② Two- and three-pole HACR rated.

③ 100% rated circuit breaker.

④ DC rating not available with electronic trip.

⑤ Available with integral ground fault protection.

⑥ 100k based on NEMA test procedure.

⑦ The 400 A frame must use trip units of ratings 100–400, while the 600 A frame must use trip units of ratings 500, 600 or designated by H, such as H250.

The H as the leading character of the ampacity indicates a high instantaneous version of the breaker for coordination purposes. H ratings must use 600 A frame.

Series Rated Combinations

Underwriters Laboratories permits panelboards to be labeled with a short-circuit rating of up to 200 kA symmetrical where UL listed combinations of main and branch circuit breakers are used.

These combinations consist of main breakers or fusible devices connected ahead of and in series with approved conventional breakers used as branch devices.

Two arrangements are acceptable and comply with UL standards for panelboards. **The main circuit breaker or fusible switch may be installed in the panel as a main device, or it may be mounted remote (directly upstream) from the panel.** In either case, the approved main and branch combinations must be followed. These arrangements are acceptable and are UL listed having been tested in accordance with UL 67 standards.

For more information on product series ratings, please refer to the Eaton website at <https://www.eaton.com/us/en-us/products/low-voltage-power-distribution/control-systems/series-rating.html> or download Eaton [Information Manual 1C96944H02](#).

Applying Series Ratings

The following is provided to use the series rating tables located within [document 1C96944H02](#).

1. Determine the available system voltage and fault current.
2. Select the appropriate table using the system voltage.
3. Use the appropriate “Series Equipment Rating” column equal to, or greater than, the available fault current, to determine the allowable UL recognized combinations of main (upstream) and branch (downstream) overcurrent devices. Main devices are shown in bold/shaded areas. Respective branch breakers are shown directly below their associated main device. If a rating is not initially found in a column, first look to the columns to the right for higher “Series Equipment Ratings” within the same table. If still not found, use ratings from table of a higher system voltage (higher numbered table(s)).

Type PRL1X



Contents

<i>Description</i>	<i>Page</i>
Product Description	V2-T3-7
Application Description	V2-T3-8
Standards and Certifications	V2-T3-10
Power Xpert Release Trip Unit for Molded Case Circuit Breakers	V2-T3-11
Technical Data and Specifications	V2-T3-12
Type PRL1X	
Product Selection	V2-T3-19
Box Sizing and Selection	V2-T3-20
Type PRL1XF	V2-T3-22
Type PRL1X-LX	V2-T3-25
Type PRL2X	V2-T3-29
Type PRL2XF	V2-T3-33
Type PRL2X-LX	V2-T3-36
Retrofit Panelboard	V2-T3-40
Type PRL3E	V2-T3-48
Type PRL3X	V2-T3-52
Type PRL3XF	V2-T3-56
Type PRL3FQS	V2-T3-59
Type PRL4X	V2-T3-62
Type PRL4DX	V2-T3-72

Type PRL1X

Product Description

- 240 Vac maximum
- Three-phase four-wire, three-phase three-wire, single-phase three-wire, single-phase two-wire
- 600 A maximum mains
- 100 A maximum branch breakers
- Bolt-on or plug-on branch breakers
- Each branch connector is capable of up to a total of 140 A maximum by breaker ampere rating
- Factory assembled
- Refer to **Page V2-T3-7** for additional information

Application Description

- Lighting branch panelboard
- Fully rated or series rated
- Interrupting ratings up to 200 kA symmetrical
- Suitable for use as Service Entrance Equipment, when specified on the order
- See **Pages V2-T3-7** through **V2-T3-17** for additional information

Standards and Certifications

- UL 67, UL 50
- CSA C22.2 No. 29
- Federal Specification W-P-115c
- Refer to **Page V2-T3-10** for additional information



Product Selection

Type PRL1X



PRL1X

Ampere Rating	Interrupting Rating (kA Sym.) 240 Vac	Breaker Type
Main Lug Only		
100	—	—
225	—	—
400	—	—
600	—	—
Main Breaker		
100	10	BAB
100	35	PDG2xF
100	22	QBHW
100	35	PDD2xF
100	65	PDD2xG
100	65	PDG2xG
100	100	PDD2xM
100	100	PDG2xM
225	35	PDD2xF
225	65	PDD2xG
225	100	PDD2xM
400	65	PDD3xG
400	65	PDF3xG ⑤
400	65	PDG3xG ⑤
400	100	PDF3xM ⑤
400	100	PDG3xM ⑤
400	100	LHH
400	200	PDG3xP ⑤
600	65	PDG3xG ⑤
600	85	LGS
600	100	PDG3xM ⑤
600	200	PDG3xP ⑤

PRL1X Branch Circuit Breakers

Bolt-on = BAB, QBHW, QBGF, QBHGF, QBGFEP, QBHGFEP, QBAF, QBAG, QBHAF, QBHAG
 Plug-on = HQP, QPHW, QPGF, QPHGF, QPGFEP, QPHGFEP

Ampere Rating	Interrupting Rating (kA Sym.) 240 Vac ①	Breaker Type
15–60	10	BAB, HQP
70	10	BAB, HQP
80–100	10	BAB, HQP
15–50 ②	10	QBGF, QPGF ③
15–50 ②	10	QBGFEP, QPGFEP ④
15–20	10	QB CAF ⑤
15–20	10	QB-GF
15–20	10	QB-EP
15–20	10	QB-AFGF ⑤
15–20	10	QB-CAF ⑤
15–60	10	BAB-D, HQP-D ⑥
15–30	10	BAB-C, HQP-B ⑦
15–30	10	BABRP ⑧
15–30	10	BABRSP ⑧
15–60	22	QBHW, QPHW
70	22	QBHW, QPHW
80–100	22	QBHW, QPHW
15–30	22	QBHGF, QPHGF ③
15–30	22	QBHGFEP, QPHGFEP ④
15–20	22	QBHCAF ⑤
15–20	22	QBH-GF
15–20	22	QBH-EP
15–20	22	QBH-AFGF ⑤
15–20	22	QBH-CAF ⑤
Provision	—	—

Notes

- ① Single-pole breakers are rated 120 Vac maximum.
- ② 50 A devices are available as two-pole only.
- ③ GFCI for 5 mA personnel protection.
- ④ GFP for 30 mA equipment protection.
- ⑤ Arc fault circuit breaker.
- ⑥ HID (High Intensity Discharge) rated breaker.
- ⑦ Switching neutral breaker. single-pole device requires two-pole space, two-pole device requires three-pole space.
- ⑧ Remote operated circuit breaker.
- ⑨ The 400 A frame must use trip units of ratings 100–400, while the 600 A frame must use trip units of ratings 500, 600 or designated by H, such as H250. The H as the leading character of the ampacity indicates a high instantaneous version of the breaker for coordination purposes. H ratings must use 600 A frame.

Box Sizing and Selection

Approximate Dimensions in Inches (mm)

Assembled Circuit Breaker Panelboards and Lighting Controls

Box dimensions along with box and trim catalog numbers for all standard panelboard types are found on

Page V2-T3-21.

Instructions

1. Using description of the required panelboard, select the rating and type of main required.
2. Count the total number of branch circuit poles, including provisions, required in the panelboard. Do not count main breaker poles. Convert two- or three-pole branch breaker to single-poles, i.e., three-pole breaker, count as three poles.

Determine sub-feed breaker or through-feed lug requirements.
3. Select the main ampere rating section from table on **Page V2-T3-21.**
4. Select panelboard type from first column, main breaker frame, if applicable, from second column, and sub-feed breaker frame, if applicable, from the third column.
5. From Step #2, determine the number of branch circuits in Column 4.
6. Read box dimensions, box and trim catalog numbers across columns to the right. Specify surface or flush mounting on the order.

Cabinets

Fronts are code-gauge steel, ANSI-61 light gray painted finish.

Boxes are code-gauge galvanized steel without knockouts. Standard depth is 5-3/4 inches (146.1 mm). Standard width is 20 inches (508.0 mm). An optional 28-inch (711.2 mm) wide box is available.

Top and Bottom Gutters

5-1/2 inches (139.7 mm) minimum.

Approximate Dimensions in Inches (mm)

PRL1X Panelboard Sizing

Panelboard Types	Main Breaker Types and Mounting Position (H) = Horizontal (V) = Vertical	Sub-Feed Breaker Types and Mounting Position (H) = Horizontal (V) = Vertical	Maximum No. of Branch Circuits Including Provisions	Box Dimensions ①			YS Box Catalog Number	LT Trim Catalog Number	EZ Box Catalog Number	EZ Trim Catalog Number
				Height	Width	Depth				
100 A										
Main breaker	BAB, QBHW (H)	—	15	36.00 (914.4)	20.00 (508.0)	5.75 (146.1)	YS2036	LT2036S or F	EZB2036R	EZT2036S or F
		—	27	48.00 (1219.2)	20.00 (508.0)	5.75 (146.1)	YS2048	LT2048S or F	EZB2048R	EZT2048S or F
		—	39	48.00 (1219.2)	20.00 (508.0)	5.75 (146.1)	YS2048	LT2048S or F	EZB2048R	EZT2048S or F
		—	42	60.00 (1524.0)	20.00 (508.0)	5.75 (146.1)	YS2060	LT2060S or F	EZB2060R	EZT2060S or F
Main lugs or main breaker	PDG2xF, PDG2xG, PDG2xM (V)	—	18	36.00 (914.4)	20.00 (508.0)	5.75 (146.1)	YS2036	LT2036S or F	EZB2036R	EZT2036S or F
		—	30	48.00 (1219.2)	20.00 (508.0)	5.75 (146.1)	YS2048	LT2048S or F	EZB2048R	EZT2048S or F
		—	42	48.00 (1219.2)	20.00 (508.0)	5.75 (146.1)	YS2048	LT2048S or F	EZB2048R	EZT2048S or F
Main lugs or main breaker with 100 A through-feed lugs or sub-feed breaker	PDG2xF, PDG2xG, PDG2xM (V)	PDG2xF, PDG2xG, PDG2xM (V)	18	48.00 (1219.2)	20.00 (508.0)	5.75 (146.1)	YS2048	LT2048S or F	EZB2048R	EZT2048S or F
		—	30	48.00 (1219.2)	20.00 (508.0)	5.75 (146.1)	YS2048	LT2048S or F	EZB2048R	EZT2048S or F
		—	42	60.00 (1524.0)	20.00 (508.0)	5.75 (146.1)	YS2060	LT2060S or F	EZB2060R	EZT2060S or F
225 A										
Main lugs or main breaker	PDD2xF, PDD2xG, PDD2xM, PDG2xG, PDG2xM (V)	—	18	36.00 (914.4)	20.00 (508.0)	5.75 (146.1)	YS2036	LT2036S or F	EZB2036R	EZT2036S or F
		—	30	48.00 (1219.2)	20.00 (508.0)	5.75 (146.1)	YS2048	LT2048S or F	EZB2048R	EZT2048S or F
		—	42	48.00 (1219.2)	20.00 (508.0)	5.75 (146.1)	YS2048	LT2048S or F	EZB2048R	EZT2048S or F
Main lugs or main breaker with 225 A throughfeed lugs or sub-feed breaker	PDG2xG, PDG2xM, PDD2xG, PDD2xM (V)	PDG2xG, PDG2xM, PDD2xG, PDD2xM (V)	18	48.00 (1219.2)	20.00 (508.0)	5.75 (146.1)	YS2048	LT2048S or F	EZB2048R	EZT2048S or F
		—	30	60.00 (1524.0)	20.00 (508.0)	5.75 (146.1)	YS2060	LT2060S or F	EZB2060R	EZT2060S or F
		—	42	60.00 (1524.0)	20.00 (508.0)	5.75 (146.1)	YS2060	LT2060S or F	EZB2060R	EZT2060S or F
400 A										
Main breaker	PDD3xG, PDG3xG, PDG3xM, PDG3xP, LHH (V)	—	18	48.00 (1219.2)	20.00 (508.0)	5.75 (146.1)	YS2048	LT2048S or F	EZB2048R	EZT2048S or F
		—	30	60.00 (1524.0)	20.00 (508.0)	5.75 (146.1)	YS2060	LT2060S or F	EZB2060R	EZT2060S or F
		—	42	60.00 (1524.0)	20.00 (508.0)	5.75 (146.1)	YS2060	LT2060S or F	EZB2060R	EZT2060S or F
Main lugs or main breaker with 225 A through-feed lugs or sub-feed breaker	PDD3xG, PDG3xG, PDG3xM, PDG3xP, LHH (V)	PDG2xG, PDG2xM, PDD2xG, PDD2xM (V)	18	60.00 (1524.0)	20.00 (508.0)	5.75 (146.1)	YS2060	LT2060S or F	EZB2060R	EZT2060S or F
		—	30	60.00 (1524.0)	20.00 (508.0)	5.75 (146.1)	YS2060	LT2060S or F	EZB2060R	EZT2060S or F
		—	42	72.00 (1828.8)	20.00 (508.0)	5.75 (146.1)	YS2072	LT2072S or F	EZB2072R	EZT2072S or F
Main breaker with 400 A through-feed lugs or sub-feed breaker	PDD3xG, PDG3xG, PDG3xM, PDG3xP, LHH (V)	PDG3xG, PDG3xG, PDG3xM, PDG3xP (V)	18	72.00 (1828.8)	20.00 (508.0)	5.75 (146.1)	YS2072	LT2072S or F	EZB2072R	EZT2072S or F
		—	30	72.00 (1828.8)	20.00 (508.0)	5.75 (146.1)	YS2072	LT2072S or F	EZB2072R	EZT2072S or F
		—	42	90.00 (2286.0)	20.00 (508.0)	5.75 (146.1)	YS2090	LT2090S or F	EZB2090R	EZT2090S or F
600 A										
Main breaker	PDG3xG, LGS, PDG3xM, PDG3xP (V)	—	18	60.00 (1524.0)	20.00 (508.0)	5.75 (146.1)	YS2060	LT2060S or F	EZB2060R	EZT2060S or F
		—	30	60.00 (1524.0)	20.00 (508.0)	5.75 (146.1)	YS2060	LT2060S or F	EZB2060R	EZT2060S or F
		—	42	72.00 (1828.8)	20.00 (508.0)	5.75 (146.1)	YS2072	LT2072S or F	EZB2072R	EZT2072S or F
Main lugs or main breaker with 225 A through-feed lugs or sub-feed breaker	PDG3xG, LGS, PDG3xM, PDG3xP, (V)	PDG2xG, PDG2xM, PDD2xG, PDD2xM (V)	18	72.00 (1828.8)	20.00 (508.0)	5.75 (146.1)	YS2072	LT2072S or F	EZB2072R	EZT2072S or F
		—	30	72.00 (1828.8)	20.00 (508.0)	5.75 (146.1)	YS2072	LT2072S or F	EZB2072R	EZT2072S or F
		—	42	90.00 (2286.0)	20.00 (508.0)	5.75 (146.1)	YS2090	LT2090S or F	EZB2090R	EZT2090S or F
Main breaker with 400 A through-feed lugs or sub-feed breaker	PDG3xG, LGS, PDG3xM, PDG3xP, (V)	PDG3xG, PDG3xG, PDG3xM, PDG3xP (V)	18	72.00 (1828.8)	20.00 (508.0)	5.75 (146.1)	YS2072	LT2072S or F	EZB2072R	EZT2072S or F
		—	30	90.00 (2286.0)	20.00 (508.0)	5.75 (146.1)	YS2090	LT2090S or F	EZB2090R	EZT2090S or F
		—	42	90.00 (2286.0)	20.00 (508.0)	5.75 (146.1)	YS2090	LT2090S or F	EZB2090R	EZT2090S or F
Main breaker with 600 A through-feed lugs or sub-feed breaker	PDG3xG, LGS, PDG3xM, PDG3xP (V)	PDG3xG, LGS, PDG3xM, PDG3xP (V)	18	72.00 (1828.8)	20.00 (508.0)	5.75 (146.1)	YS2072	LT2072S or F	EZB2072R	EZT2072S or F
		—	30	90.00 (2286.0)	20.00 (508.0)	5.75 (146.1)	YS2090	LT2090S or F	EZB2090R	EZT2090S or F
		—	42	90.00 (2286.0)	20.00 (508.0)	5.75 (146.1)	YS2090	LT2090S or F	EZB2090R	EZT2090S or F

Note

① Smaller panelboard box sizes are available if required. Contact Eaton for application information.

Type PRL1XF



Type PRL1XF

Product Description

- 240 Vac maximum
- 400 A maximum mains
- Three-phase four-wire, single-phase three-wire
- 30 A maximum branch devices
- Factory assembled

Application Description

- Lighting branch panelboards
- Instrument protection
- Fully rated
- Interrupting ratings up to 200 kA symmetrical when protected by fuse

Contents

Description

	<i>Page</i>
Product Description	V2-T3-7
Application Description	V2-T3-8
Standards and Certifications	V2-T3-10
Power Xpert Release Trip Unit for Molded Case Circuit Breakers	V2-T3-11
Technical Data and Specifications	V2-T3-12
Type PRL1X	V2-T3-18
Type PRL1XF	
Product Selection	V2-T3-23
Box Sizing and Selection	V2-T3-23
Type PRL1X-LX	V2-T3-25
Type PRL2X	V2-T3-29
Type PRL2XF	V2-T3-33
Type PRL2X-LX	V2-T3-36
Retrofit Panelboard	V2-T3-40
Type PRL3E	V2-T3-48
Type PRL3X	V2-T3-52
Type PRL3XF	V2-T3-56
Type PRL3FQS	V2-T3-59
Type PRL4X	V2-T3-62
Type PRL4DX	V2-T3-72

Standards and Certifications

- UL 67, UL 50



Product Selection

Type PRL1XF



PRL1XF

Ampere Rating	Interrupting Rating (kA Sym.) 240 Vac	Breaker Type
Main Lug Only		
100	—	—
225	—	—
400	—	—
Main Breaker		
100	18	PDG2xF
100	35	PDD2xF
100	65	PDD2xG
100	65	PDG2xG
100	100	PDD2xM
100	100	PDG2xM
225	35	PDD2xF
225	65	PDD2xG
225	65	PDG2xG
225	100	PDD2xM
225	100	PDG2xM
400	65	PDD3xG
400	65	PDG3xG ①
400	100	PDG3xM ①
400	200	PDG3xP ①
400	200	LHH

PRL1XF—Branch Overcurrent Devices

Hybrid breaker/fuse (Class CC) branch device

Ampere Rating	Interrupting Rating	Breaker Type
30	200	Hybrid

Note

① The 400 A frame must use trip units of ratings 100–400, while the 600 A frame must use trip units of ratings 500, 600 or designated by H, such as H250. The H as the leading character of the ampacity indicates a high instantaneous version of the breaker for coordination purposes. H ratings must use 600 A frame.

Box Sizing and Selection

Approximate Dimensions in Inches (mm)

Assembled Circuit Breaker Panelboards

Box dimensions and box and trim catalog numbers for all standard panelboard types are found on **Page V2-T3-24**.

Instructions

- Using description of the required panelboard, select the rating and type of main required.
- Count the total number of branch circuit poles, including provisions, required in the panelboard.
Determine through-feed lug requirements.
- Select the main ampere rating section from table on **Page V2-T3-24**.
- Select panelboard type from first column, main breaker frame.
- From Step #2, determine the number of branch circuits in Column 4.
- Read box dimensions, box and trim catalog numbers across columns to the right. Specify surface or flush mounting on the order.

Cabinets

Fronts are code-gauge steel, ANSI-61 light gray painted finish.

Boxes are code-gauge galvanized steel without knockouts. Standard depth is 5-3/4 inches (146.1 mm). Standard width is 20 inches (508.0 mm). An optional 28-inch (711.2 mm) wide box is available.

Top and Bottom Gutters

5-1/2 inches (139.7 mm) minimum.

3.3

Panelboards and Lighting Control

Pow-R-Line Xpert Panelboards

Approximate Dimensions in Inches (mm)

PRL1XF Panelboard Sizing

3

Panelboard Types	Main Breaker Types and Mounting Position (H) = Horizontal (V) = Vertical	Maximum No. of Branch Circuits Including Provisions	Box Dimensions ^①			YS Box Catalog Number	LT Trim Catalog Number	EZ Box Catalog Number	EZ Trim Catalog Number
			Height	Width	Depth				
100 A									
Main lugs or main breaker	PDG2xF PDG2xG, PDG2xM (V)	18	36.00 (914.4)	20.00 (508.0)	5.75 (146.1)	YS2036	LT2036S or F	EZB2036R	EZT2036S or F
		30	48.00 (1219.2)	20.00 (508.0)	5.75 (146.1)	YS2048	LT2048S or F	EZB2048R	EZT2048S or F
		42	48.00 (1219.2)	20.00 (508.0)	5.75 (146.1)	YS2048	LT2048S or F	EZB2048R	EZT2048S or F
Main lugs or main breaker with 100 A through-feed lugs	PDG2xF PDG2xG PDG2xM (V)	18	48.00 (1219.2)	20.00 (508.0)	5.75 (146.1)	YS2048	LT2048S or F	EZB2048R	EZT2048S or F
		30	48.00 (1219.2)	20.00 (508.0)	5.75 (146.1)	YS2048	LT2048S or F	EZB2048R	EZT2048S or F
		42	60.00 (1524.0)	20.00 (508.0)	5.75 (146.1)	YS2060	LT2060S or F	EZB2060R	EZT2060S or F
225 A									
Main lugs or main breaker	PDD2xF, PDD2xG, PDD2xM, PDG2xG, PDG2xM (V)	18	36.00 (914.4)	20.00 (508.0)	5.75 (146.1)	YS2036	LT2036S or F	EZB2036R	EZT2036S or F
		30	48.00 (1219.2)	20.00 (508.0)	5.75 (146.1)	YS2048	LT2048S or F	EZB2048R	EZT2048S or F
		42	48.00 (1219.2)	20.00 (508.0)	5.75 (146.1)	YS2048	LT2048S or F	EZB2048R	EZT2048S or F
Main lugs or main breaker with 225 A through-feed lugs	PDG2xG, PDG2xM, PDD2xG, PDD2xM (V)	18	48.00 (1219.2)	20.00 (508.0)	5.75 (146.1)	YS2048	LT2048S or F	EZB2048R	EZT2048S or F
		30	60.00 (1524.0)	20.00 (508.0)	5.75 (146.1)	YS2060	LT2060S or F	EZB2060R	EZT2060S or F
		42	60.00 (1524.0)	20.00 (508.0)	5.75 (146.1)	YS2060	LT2060S or F	EZB2060R	EZT2060S or F
400 A									
Main breaker	PDD3xG, PDG3xG, PDG3xM, PDG3xP, LHH (V)	18	48.00 (1219.2)	20.00 (508.0)	5.75 (146.1)	YS2048	LT2048S or F	EZB2048R	EZT2048S or F
		30	60.00 (1524.0)	20.00 (508.0)	5.75 (146.1)	YS2060	LT2060S or F	EZB2060R	EZT2060S or F
		42	60.00 (1524.0)	20.00 (508.0)	5.75 (146.1)	YS2060	LT2060S or F	EZB2060R	EZT2060S or F
Main lugs or main breaker with 225 A through-feed lugs	PDD3xG, PDG3xG, PDG3xM, PDG3xP, LHH (V)	18	60.00 (1524.0)	20.00 (508.0)	5.75 (146.1)	YS2060	LT2060S or F	EZB2060R	EZT2060S or F
		30	60.00 (1524.0)	20.00 (508.0)	5.75 (146.1)	YS2060	LT2060S or F	EZB2060R	EZT2060S or F
		42	72.00 (1828.8)	20.00 (508.0)	5.75 (146.1)	YS2072	LT2072S or F	EZB2072R	EZT2072S or F
Main breaker with 400 A through-feed lugs	PDD3xG, PDG3xG, PDG3xM, PDG3xP, LHH (V)	18	72.00 (1828.8)	20.00 (508.0)	5.75 (146.1)	YS2072	LT2072S or F	EZB2072R	EZT2072S or F
		30	72.00 (1828.8)	20.00 (508.0)	5.75 (146.1)	YS2072	LT2072S or F	EZB2072R	EZT2072S or F
		42	90.00 (2286.0)	20.00 (508.0)	5.75 (146.1)	YS2090	LT2090S or F	EZB2090R	EZT2090S or F

Note

① Smaller panelboard box sizes are available if required. Contact Eaton for application information.

Type PRL1X-LX, Column Type



Contents

Description	Page
Product Description	V2-T3-7
Application Description	V2-T3-8
Standards and Certifications	V2-T3-10
Power Xpert Release Trip Unit for Molded Case Circuit Breakers	V2-T3-11
Technical Data and Specifications	V2-T3-12
Type PRL1X	V2-T3-18
Type PRL1XF	V2-T3-22
Type PRL1X-LX	
Product Selection	V2-T3-26
Box Sizing and Selection	V2-T3-27
Type PRL2X	V2-T3-29
Type PRL2XF	V2-T3-33
Type PRL2X-LX	V2-T3-36
Retrofit Panelboard	V2-T3-40
Type PRL3E	V2-T3-48
Type PRL3X	V2-T3-52
Type PRL3XF	V2-T3-56
Type PRL3FQS	V2-T3-59
Type PRL4X	V2-T3-62
Type PRL4DX	V2-T3-72

Type PRL1X-LX

Product Description

- 240 Vac maximum
- Three-phase four-wire, three-phase three-wire, single-phase three-wire, single-phase two-wire
- 225 A maximum mains
- 100 A maximum branch breakers
- Bolt-on branch breakers
- Factory assembled
- Refer to **Page V2-T3-7** for additional information

Application Description

- Lighting branch panelboard
- Column mounting width
- Fully rated or series rated
- Interrupting ratings up to 200 kA symmetrical
- See **Pages V2-T3-7** through **V2-T3-17** for additional information

Standards and Certifications

- UL 67, UL 50
- CSA C22.2 No. 29
- Federal Specification W-P-115c
- Refer to **Page V2-T3-10** for additional information



Product Selection

Type PRL1X-LX



3

PRL1X-LX

Ampere Rating	Interrupting Rating (kA Sym.) 240 Vac	Breaker Type
Main Lug Only		
100	—	—
225	—	—
Main Breaker		
100	10	BAB
100	35	PDG2xF
100	22	QBHW
100	35	PDD2xF
100	35	PDD2xG
100	65	PDG2xG
100	100	PDD2xM
100	100	PDG2xM
255	35	PDD2xF
225	65	PDD2xG
225	100	PDD2xM

Branch Circuit Breakers—PRL1X-LX ^①

Ampere Rating	Interrupting Rating (kA Sym.) 240 Vac ^②	Breaker Type
15–60	10	BAB
70	10	BAB
80–100	10	BAB
15–50 ^③	10	QBGF ^④
15–50 ^③	10	QBGFEP ^⑤
15–20	10	QBCAF ^⑥
15–30	10	BABRP ^⑦
15–30	10	BABRSP ^⑦
15–60	22	QBHW
70	22	QBHW
80–100	22	QBHW
15–30	22	QBHGF ^④
15–30	22	QBHGFE ^⑤
15–20	22	QBHCAF ^⑥
Provision	—	—

Pull Box With Extension Trough

Includes pull box with trough extension. For additional trough extensions, refer to table below.

Description	Catalog Number
Pullbox with 36-inch trough	XCTXB036
Pullbox with 48-inch trough	XCTXB048
Pullbox with 60-inch trough	XCTXB060
Pullbox with 72-inch trough	XCTXB072
Pullbox with 84-inch trough	XCTXB084

Neutral Bars

When column-type panels are furnished with trough extensions and pull box, the neutral bar will be placed in the pull box unless otherwise specified.

When troughs and pull box are not furnished, the neutral bar will be located on the panel at the same end as the main.

Additional Trough Extensions

Width and depth are the same as the panelboard.

Length Inches (mm)	Catalog Number
36.00 (914.4)	CTXB036
48.00 (1219.2)	CTXB048
60.00 (1524.0)	CTXB060
72.00 (1828.8)	CTXB072
84.00 (2133.6)	CTXB084

Notes

- ① 240 V breakers must be used on three-phase, three-wire, 240 V delta systems or on the high leg of a midpoint delta grounded system.
- ② Single-pole breakers are rated 120 Vac maximum.
- ③ 50 A devices are available as two-pole only.
- ④ GFCI for 5 mA personnel protection.
- ⑤ GFP for 30 mA equipment protection.
- ⑥ Arc fault circuit breaker.
- ⑦ Remote operated circuit breaker.

Box Sizing and Selection

Approximate Dimensions in Inches (mm)

Assembled Circuit Breaker Panelboards

Box dimensions, box and trim catalog numbers for standard column-type panelboards listed are available from tables on **Page V2-T3-28**.

Instructions

1. Using description of the required panelboard, select the rating and type of main required.
 - a. 100 A panelboards—**Page V2-T3-28**.
 - b. 225 A panelboards—**Page V2-T3-28**.
2. Count the total number of branch circuit poles, including provisions, required in the panelboard. Do not count main breaker poles. Convert two- or three-pole branch breaker to single poles, i.e., three-pole breaker, count as three poles. Determine sub-feed breaker or through-feed lug requirements.
3. Select the panelboard main ampere rating from tables on **Page V2-T3-28**.
4. Choose panelboard type from first column; main breaker frame and designation, if applicable, from second column; and sub-feed breaker frame and designation, if applicable, from the third column.
5. From Step #2, determine the number of branch circuits in Column 4.
6. Read box dimensions, box and trim catalog numbers across columns to the right. All panels are surface mounted.

Cabinets

Boxes and trims are code-gauge steel, ANSI-61 light gray painted finish.

Boxes are furnished without knockouts. Standard depth is 6.00 inches (152.4 mm). Standard width is 8.63 inches (219.1 mm).

Top and Bottom Gutters

4.50 inches (114.3 mm) minimum.

Left Side Gutter

4.38 inches (111.2 mm) minimum.

Pull Box

Pull box is furnished without knockouts. Standard dimensions:

Pull Box Dimensions

Height	Width	Depth
12.00 (304.8)	16.00 (406.4)	6.00 (152.4)

PRL1X-LX Trough Extension

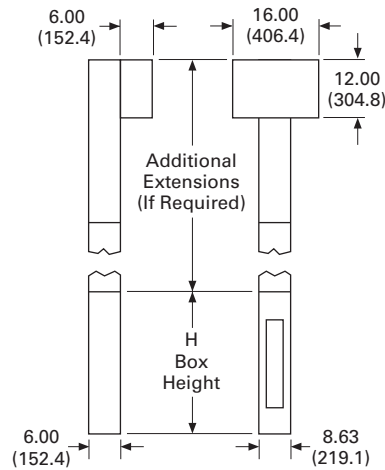

Trough Extension

When extension troughs are used, Section 376 of the National Electrical Code should be observed: 376. Number of Conductors. Wireways shall not contain more than 30 conductors at any cross section, unless the conductors are for signal circuits or are control conductors between a motor and its starter and used only for starting duty. The sum of the cross-sectional areas of all contained conductors at any cross section of a wireway shall not exceed 20% of the interior cross-sectional area of the wireway.

3.3

Panelboards and Lighting Control

Pow-R-Line Xpert Panelboards

Approximate Dimensions in Inches (mm)

100 A Maximum PRL1X-LX Column-Type Panelboard Sizing

Panelboard Types	Main Breaker Types Mounting: (H) = Horizontal (V) = Vertical	Sub-Feed Breaker Types Vertical Mounting	Maximum Number of Branch Circuits Including Provisions	Box Dimensions			Box Catalog Number	Trim Catalog Number ^①
				Height	Width	Depth		
Main breaker	BAB, QBHW (H)	—	27	69.00 (1752.6)	8.63 (219.2)	6.00 (152.4)	YSC969	LTC969S
		—	39	81.00 (2057.4)	8.63 (219.2)	6.00 (152.4)	YSC981	LTC981S
Main lugs or main breaker	PDG2xF, PDD2xF PDD2xG, PDG2xG, PDG2xM (V)	—	30	69.00 (1752.6)	8.63 (219.2)	6.00 (152.4)	YSC969	LTC969S
		—	42	81.00 (2057.4)	8.63 (219.2)	6.00 (152.4)	YSC981	LTC981S
Main lugs or main breaker with 100 A through-feed lugs or sub-feed breaker	PDG2xF, PDD2xF PDD2xG, PDG2xG, PDG2xM (V)	PDG2xF, PDG2xG, PDG2xM	30	78.00 (1981.2)	8.63 (219.2)	6.00 (152.4)	YSC978	LTC978S
		—	42	90.00 (2286.0)	8.63 (219.2)	6.00 (152.4)	YSC990	LTC990S

225 A Maximum PRL1X-LX Column-Type Panelboard Sizing

Panelboard Types	Main Breaker Types Vertical Mounting	Sub-Feed Breaker Types	Maximum Number of Branch Circuits Including Provisions	Box Dimensions Inches			Box Catalog Number	Trim Catalog Number ^①
				Height	Width	Depth		
Main lugs or main breaker	PDD2xF PDD2xG, PDD2xM	—	30	69.00 (1752.6)	8.63 (219.2)	6.00 (152.4)	YSC969	LTC969S
		—	42	81.00 (2057.4)	8.63 (219.2)	6.00 (152.4)	YSC981	LTC981S
Main lugs or main breaker with 225 A through-feed lugs or sub-feed breaker	PDD2xF PDD2xG, PDD2xM	PDG2xF, PDG2xG, PDG2xM, PDD2xF, PDD2xG, PDD2xM	30	78.00 (1981.2)	8.63 (219.2)	6.00 (152.4)	YSC978	LTC978S
		—	42	90.00 (2286.0)	8.63 (219.2)	6.00 (152.4)	YSC990	LTC990S

Note

^① Add suffix B to trim catalog number for bottom fed panelboards (i.e., LTC969SB).

Type PRL2X



Contents

Description	Page
Product Description	V2-T3-7
Application Description	V2-T3-8
Standards and Certifications	V2-T3-10
Power Xpert Release Trip Unit for Molded Case Circuit Breakers	V2-T3-11
Technical Data and Specifications	V2-T3-12
Type PRL1X	V2-T3-18
Type PRL1XF	V2-T3-22
Type PRL1X-LX	V2-T3-25
Type PRL2X	
Product Selection	V2-T3-30
Box Sizing and Selection	V2-T3-31
Type PRL2XF	V2-T3-33
Type PRL2X-LX	V2-T3-36
Retrofit Panelboard	V2-T3-40
Type PRL3E	V2-T3-48
Type PRL3X	V2-T3-52
Type PRL3XF	V2-T3-56
Type PRL3FQS	V2-T3-59
Type PRL4X	V2-T3-62
Type PRL4DX	V2-T3-72

Type PRL2X

Product Description

- 480Y/277 Vac maximum (125 Vdc)
- Three-phase four-wire, three-phase three-wire, single-phase three-wire, single-phase two-wire
- 600 A maximum mains
- 100 A maximum branch breakers
- Bolt-on branch breakers
- Each branch connector is capable of up to a total of 140 A maximum by breaker ampere rating
- Factory assembled
- Refer to **Page V2-T3-7** for additional information

Application Description

- Lighting branch panelboard
- Fully rated or series rated
- Interrupting ratings up to 200 kA symmetrical
- Suitable for use as Service Entrance Equipment, when specified on the order
- See **Pages V2-T3-7** through **V2-T3-17** for additional information

Standards and Certifications

- UL 67, UL 50
- CSA C22.2 No. 29
- Federal Specification W-P-115c
- Refer to **Page V2-T3-10** for additional information



Listed

Product Selection

Type PRL2X



PRL2X

Ampere Rating	Interrupting Rating (kA Symmetrical)			Breaker Type
	240 Vac	480Y/277 Vac	125/250 Vdc	
Main Lug Only				
100	—	—	—	—
225	—	—	—	—
400	—	—	—	—
600	—	—	—	—
Main Breaker				
100	65	14	14	GHB
100	35	25	10	PDG2xF
100	65	35	10	PDG2xG
100	100	65	22	PDG2xM
100	200	100	22	PDG2xP
225	65	—	—	PDD2xG
225	65	35	10	PDG2xG
225	100	65	22	PDG2xM
225	200	100	22	PDG2xP
400	65	35	10	PDG3xG ⑥
400	65	35	—	PDF3xG ⑥
400	100	65	—	PDF3xM ⑥
400	100	65	22	PDG3xM ⑥
400	100	65	—	LHH
400	200	100	22	PDG3xP ⑥
600	65	35	22	PDG3xG ⑥
600	85	50	22	LGS
600	100	65	42	PDG3xM ⑥
600	200	100	42	PDG3xP ⑥

PRL2X Branch Circuit Breakers

Ampere Rating	Interrupting Rating (kA Symmetrical)			Breaker Type
	240 Vac ①	480Y/277 Vac	125/250 Vdc	
15–30	65	14	—	GHQ ②
15–20	65	14	14	GHB ②
25–60	65	14	14	GHB ②
70–100	65	14	14	GHB ②
15–30	65	25	—	HGHB ②
15–20	65	14	—	GHQRD
15–20	65	14	—	GHQRSP ③
15–60	—	14	—	GHBGFEP ②④
15–20	—	14	—	GHBHID ②⑤
Provision	—	—	—	—

Notes

- ① Interrupting ratings in this column are applicable to 120 Vac for single-pole breakers.
- ② Must be used on 480Y/277 V grounded wye systems only.
- ③ Remote operated circuit breaker.
- ④ GFP for 30 mA equipment protection. Requires two-pole spaces. 277 Vac only.
- ⑤ HID (High Intensity Discharge) rated breaker.
- ⑥ The 400 A frame must use trip units of ratings 100–400, while the 600 A frame must use trip units of ratings 500, 600 or designated by H, such as H250. The H as the leading character of the ampacity indicates a high instantaneous version of the breaker for coordination purposes. H ratings must use 600 A frame.

Box Sizing and Selection

Approximate Dimensions in Inches (mm)

Assembled Circuit Breaker Panelboards and Lighting Controls

Box dimensions and box and trim catalog numbers for all standard panelboard types are found on **Page V2-T3-32**.

Instructions

1. Using description of the required panelboard, select the rating and type of main required.
2. Count the total number of branch circuit poles, including provisions, required in the panelboard. Do not count main breaker poles. Convert two- or three-pole branch breaker to single-poles, i.e., three-pole breaker, count as three poles.
Determine sub-feed breaker or through-feed lug requirements.
3. Select the main ampere rating section from table on **Page V2-T3-32**.
4. Select panelboard type from first column, main breaker frame, if applicable, from second column, and sub-feed breaker frame, if applicable, from the third column.
5. From Step #2, determine the number of branch circuits in Column 4.
6. Read box dimensions, box and trim catalog numbers across columns to the right. Specify surface or flush mounting on the order.

Cabinets

Fronts are code-gauge steel, ANSI-61 light gray painted finish.

Boxes are code-gauge galvanized steel without knockouts. Standard depth is 5-3/4 inches (146.1 mm). Standard width is 20 inches (508.0 mm). An optional 28-inch (711.2 mm) wide box is available.

Top and Bottom Gutters

5-1/2 inches (139.7 mm) minimum.

3.3

Panelboards and Lighting Control

Pow-R-Line Xpert Panelboards

Approximate Dimensions in Inches (mm)

PRL2X Panelboard Sizing

3

Panelboard Types	Main Breaker Types and Mounting Position (H) = Horizontal (V) = Vertical	Sub-Feed Breaker Types and Mounting Position (H) = Horizontal (V) = Vertical	Maximum No. of Branch Circuits Including Provisions	Box Dimensions ^①			YS Box Catalog Number	LT Trim Catalog Number	EZ Box Catalog Number	EZ Trim Catalog Number
				Height	Width	Depth				
100 A										
Main breaker	GHB (H)	—	15	36.00 (914.4)	20.00 (508.0)	5.75 (146.1)	YS2036	LT2036S or F	EZB2036R	EZT2036S or F
		—	27	48.00 (1219.2)	20.00 (508.0)	5.75 (146.1)	YS2048	LT2048S or F	EZB2048R	EZT2048S or F
		—	39	48.00 (1219.2)	20.00 (508.0)	5.75 (146.1)	YS2048	LT2048S or F	EZB2048R	EZT2048S or F
		—	42	60.00 (1524.0)	20.00 (508.0)	5.75 (146.1)	YS2060	LT2060S or F	EZB2060R	EZT2060S or F
Main lugs or main breaker	PDG2xF, PDG2xG, PDG2xM (V)	—	18	36.00 (914.4)	20.00 (508.0)	5.75 (146.1)	YS2036	LT2036S or F	EZB2036R	EZT2036S or F
		—	30	48.00 (1219.2)	20.00 (508.0)	5.75 (146.1)	YS2048	LT2048S or F	EZB2048R	EZT2048S or F
		—	42	48.00 (1219.2)	20.00 (508.0)	5.75 (146.1)	YS2048	LT2048S or F	EZB2048R	EZT2048S or F
Main lugs or main breaker with 100 A through-feed lugs or sub-feed breaker	PDG2xF, PDG2xG, PDG2xM (V)	PDG2xF, PDG2xG, PDG2xM (V)	18	48.00 (1219.2)	20.00 (508.0)	5.75 (146.1)	YS2048	LT2048S or F	EZB2048R	EZT2048S or F
			30	48.00 (1219.2)	20.00 (508.0)	5.75 (146.1)	YS2048	LT2048S or F	EZB2048R	EZT2048S or F
		—	42	60.00 (1524.0)	20.00 (508.0)	5.75 (146.1)	YS2060	LT2060S or F	EZB2060R	EZT2060S or F
			—	42	60.00 (1524.0)	20.00 (508.0)	5.75 (146.1)	YS2060	LT2060S or F	EZB2060R
225 A										
Main lugs or main breaker	PDD2xF, PDD2xG, PDD2xM, PDG2xG, PDG2xM (V)	—	18	36.00 (914.4)	20.00 (508.0)	5.75 (146.1)	YS2036	LT2036S or F	EZB2036R	EZT2036S or F
		—	30	48.00 (1219.2)	20.00 (508.0)	5.75 (146.1)	YS2048	LT2048S or F	EZB2048R	EZT2048S or F
		—	42	48.00 (1219.2)	20.00 (508.0)	5.75 (146.1)	YS2048	LT2048S or F	EZB2048R	EZT2048S or F
Main lugs or main breaker with 225 A through-feed lugs or sub-feed breaker	PDG2xF, PDG2xG, PDG2xM, PDD2xF, PDD2xG, PDD2xM (V)	PDG2xF, PDG2xG, PDG2xM, PDD2xF, PDD2xG, PDD2xM (V)	18	48.00 (1219.2)	20.00 (508.0)	5.75 (146.1)	YS2048	LT2048S or F	EZB2048R	EZT2048S or F
			30	48.00 (1219.2)	20.00 (508.0)	5.75 (146.1)	YS2048	LT2048S or F	EZB2048R	EZT2048S or F
		—	42	60.00 (1524.0)	20.00 (508.0)	5.75 (146.1)	YS2060	LT2060S or F	EZB2060R	EZT2060S or F
			—	42	60.00 (1524.0)	20.00 (508.0)	5.75 (146.1)	YS2060	LT2060S or F	EZB2060R
Main lugs or main breaker with 225 A through-feed lugs or sub-feed breaker	PDG2xF, PDG2xG, PDG2xM, PDD2xF, PDD2xG, PDD2xM (V)	PDG2xF, PDG2xG, PDG2xM, PDD2xF, PDD2xG, PDD2xM (V)	18	60.00 (1524.0)	20.00 (508.0)	5.75 (146.1)	YS2060	LT2060S or F	EZB2060R	EZT2060S or F
			30	72.00 (1828.8)	20.00 (508.0)	5.75 (146.1)	YS2072	LT2072S or F	EZB2072R	EZT2072S or F
		—	42	72.00 (1828.8)	20.00 (508.0)	5.75 (146.1)	YS2072	LT2072S or F	EZB2072R	EZT2072S or F
			—	42	72.00 (1828.8)	20.00 (508.0)	5.75 (146.1)	YS2072	LT2072S or F	EZB2072R
400 A										
Main lugs or main breaker	PDD3xG, PDG3xG, PDG3xM, PDG3xP, LHH (V)	—	18	60.00 (1524.0)	20.00 (508.0)	5.75 (146.1)	YS2060	LT2060S or F	EZB2060R	EZT2060S or F
		—	30	60.00 (1524.0)	20.00 (508.0)	5.75 (146.1)	YS2060	LT2060S or F	EZB2060R	EZT2060S or F
		—	42	72.00 (1828.8)	20.00 (508.0)	5.75 (146.1)	YS2072	LT2072S or F	EZB2072R	EZT2072S or F
Main lugs or main breaker with 225 A through-feed lugs or sub-feed breaker	PDD3xG, PDG3xG, PDG3xM, PDG3xP, LHH (V)	PDG2xF, PDG2xG, PDG2xM, PDD2xF, PDD2xG, PDD2xM (V)	18	60.00 (1524.0)	20.00 (508.0)	5.75 (146.1)	YS2060	LT2060S or F	EZB2060R	EZT2060S or F
			30	72.00 (1828.8)	20.00 (508.0)	5.75 (146.1)	YS2072	LT2072S or F	EZB2072R	EZT2072S or F
		42	72.00 (1828.8)	20.00 (508.0)	5.75 (146.1)	YS2072	LT2072S or F	EZB2072R	EZT2072S or F	
Main lugs or main breaker with 400 A through-feed lugs or sub-feed breaker	PDD3xG, PDG3xG, PDG3xM, PDG3xP, LHH (V)	PDD3xG, PDG3xG, PDG3xM, PDG3xP (V)	18	72.00 (1828.8)	20.00 (508.0)	5.75 (146.1)	YS2072	LT2072S or F	EZB2072R	EZT2072S or F
			30	90.00 (2286.0)	20.00 (508.0)	5.75 (146.1)	YS2090	LT2090S or F	EZB2090R	EZT2090S or F
		42	90.00 (2286.0)	20.00 (508.0)	5.75 (146.1)	YS2090	LT2090S or F	EZB2090R	EZT2090S or F	
600 A										
Main breaker	PDG3xG, LGS, PDG3xM, PDG3xP (V)	—	18	60.00 (1524.0)	20.00 (508.0)	5.75 (146.1)	YS2060	LT2060S or F	EZB2060R	EZT2060S or F
		—	30	60.00 (1524.0)	20.00 (508.0)	5.75 (146.1)	YS2060	LT2060S or F	EZB2060R	EZT2060S or F
		—	42	72.00 (1828.8)	20.00 (508.0)	5.75 (146.1)	YS2072	LT2072S or F	EZB2072R	EZT2072S or F
Main lugs or main breaker with 225 A through-feed lugs or sub-feed breaker	PDG3xG, LGS, PDG3xM, PDG3xP (V)	PDG2xG, PDG2xM, PDD2xG, PDD2xM (V)	18	72.00 (1828.8)	20.00 (508.0)	5.75 (146.1)	YS2072	LT2072S or F	EZB2072R	EZT2072S or F
			30	72.00 (1828.8)	20.00 (508.0)	5.75 (146.1)	YS2072	LT2072S or F	EZB2072R	EZT2072S or F
		42	90.00 (2286.0)	20.00 (508.0)	5.75 (146.1)	YS2090	LT2090S or F	EZB2090R	EZT2090S or F	
Main breaker with 400 A through-feed lugs or sub-feed breaker	PDG3xG, LGS, PDG3xM, PDG3xP (V)	PDD3xG, PDG3xG, PDG3xM, PDG3xP (V)	18	72.00 (1828.8)	20.00 (508.0)	5.75 (146.1)	YS2072	LT2072S or F	EZB2072R	EZT2072S or F
			30	90.00 (2286.0)	20.00 (508.0)	5.75 (146.1)	YS2090	LT2090S or F	EZB2090R	EZT2090S or F
		42	90.00 (2286.0)	20.00 (508.0)	5.75 (146.1)	YS2090	LT2090S or F	EZB2090R	EZT2090S or F	
Main breaker with 600 A through-feed lugs or sub-feed breaker	PDG3xG, LGS, PDG3xM, PDG3xP (V)	PDG3xG, LGS, PDG3xM, PDG3xP (V)	18	72.00 (1828.8)	20.00 (508.0)	5.75 (146.1)	YS2072	LT2072S or F	EZB2072R	EZT2072S or F
			30	90.00 (2286.0)	20.00 (508.0)	5.75 (146.1)	YS2090	LT2090S or F	EZB2090R	EZT2090S or F
		42	90.00 (2286.0)	20.00 (508.0)	5.75 (146.1)	YS2090	LT2090S or F	EZB2090R	EZT2090S or F	

Note

① Smaller panelboard box sizes are available if required. Contact Eaton for application information.

Type PRL2XF



Contents

Description	Page
Product Description	V2-T3-7
Application Description	V2-T3-8
Standards and Certifications	V2-T3-10
Power Xpert Release Trip Unit for Molded Case Circuit Breakers	V2-T3-11
Technical Data and Specifications	V2-T3-12
Type PRL1X	V2-T3-18
Type PRL1XF	V2-T3-22
Type PRL1X-LX	V2-T3-25
Type PRL2X	V2-T3-29
Type PRL2XF Product Selection	V2-T3-34
Box Sizing and Selection	V2-T3-34
Type PRL2X-LX	V2-T3-36
Retrofit Panelboard	V2-T3-40
Type PRL3E	V2-T3-48
Type PRL3X	V2-T3-52
Type PRL3XF	V2-T3-56
Type PRL3FQS	V2-T3-59
Type PRL4X	V2-T3-62
Type PRL4DX	V2-T3-72

Type PRL2XF

Product Description

- 240 Vac maximum
- 400 A maximum mains
- Three-phase four-wire, single-phase three-wire
- 30 A maximum branch devices
- Factory assembled

Application Description

- Lighting branch panelboard
- Instrument protection
- Fully rated
- Interrupting ratings up to 200 kA symmetrical when protected by fuse

Standards and Certifications

- UL 67, UL 50



Product Selection

Type PRL2XF

PRL2XF



Ampere Rating	Interrupting Rating (kA Sym.) 480Y/277 Vac	Breaker Type
Main Lug Only		
100	—	—
225	—	—
400	—	—
Main Breaker		
100	25	PDG2xF
100	35	PDG2xG
100	65	PDG2xM
225	35	PDG2xG
225	65	PDG2xM
400	35	PDG3xG
400	65	PDG3xM
400	100	PDG3xP
400	100	LHH

PRL2XF Branch Overcurrent Devices

Hybrid breaker/fuse (Class CC) branch device

Ampere Rating	Interrupting Rating (kA Sym.) 480Y/277 Vac	Breaker Type
30	200	Hybrid

Box Sizing and Selection

Approximate Dimensions in Inches (mm)

Assembled Circuit Breaker Panelboards

Box dimensions and box and trim catalog numbers for all standard panelboard types are found on **Page V2-T3-35**.

Instructions

- Using description of the required panelboard, select the rating and type of main required.
- Count the total number of branch circuit poles, including provisions, required in the panelboard.
Determine through-feed lug requirements.
- Select the main ampere rating section from table on **Page V2-T3-35**.
- Select panelboard type from first column, main breaker frame, if applicable, from second column.
- From Step #2, determine the number of branch circuits in Column 4.
- Read box dimensions, box and trim catalog numbers across columns to the right. Specify surface or flush mounting on the order.

Cabinets

Fronts are code-gauge steel, ANSI-61 light gray painted finish.

Boxes are code-gauge galvanized steel without knockouts. Standard depth is 5-3/4 inches (146.1 mm). Standard width is 20 inches (508.0 mm). An optional 28-inch (711.2 mm) wide box is available.

Top and Bottom Gutters

5-1/2 inches (139.7 mm) minimum.

Approximate Dimensions in Inches (mm)

PRL2XF Panelboard Sizing

Panelboard Types	Main Breaker Types and Mounting Position (H) = Horizontal (V) = Vertical	Maximum No. of Branch Circuits Including Provisions	Box Dimensions ①			YS Box Catalog Number	LT Trim Catalog Number	EZ Box Catalog Number	EZ Trim Catalog Number
			Height	Width	Depth				
100 A									
Main lugs or main breaker	PDG2xF PDG2xG, PDG2xM (V)	18	36.00 (914.4)	20.00 (508.0)	5.75 (146.1)	YS2036	LT2036S or F	EZB2036R	EZT2036S or F
		30	48.00 (1219.2)	20.00 (508.0)	5.75 (146.1)	YS2048	LT2048S or F	EZB2048R	EZT2048S or F
		42	48.00 (1219.2)	20.00 (508.0)	5.75 (146.1)	YS2048	LT2048S or F	EZB2048R	EZT2048S or F
Main lugs or main breaker with 100 A through-feed lugs or sub-feed breaker	PDG2xF PDG2xG PDG2xM (V)	18	48.00 (1219.2)	20.00 (508.0)	5.75 (146.1)	YS2048	LT2048S or F	EZB2048R	EZT2048S or F
		30	48.00 (1219.2)	20.00 (508.0)	5.75 (146.1)	YS2048	LT2048S or F	EZB2048R	EZT2048S or F
		42	60.00 (1524.0)	20.00 (508.0)	5.75 (146.1)	YS2060	LT2060S or F	EZB2060R	EZT2060S or F
225 A									
Main lugs or main breaker	PDD2xF, PDD2xG, PDD2xM, PDG2xG, PDG2xM (V)	18	36.00 (914.4)	20.00 (508.0)	5.75 (146.1)	YS2036	LT2036S or F	EZB2036R	EZT2036S or F
		30	48.00 (1219.2)	20.00 (508.0)	5.75 (146.1)	YS2048	LT2048S or F	EZB2048R	EZT2048S or F
		42	48.00 (1219.2)	20.00 (508.0)	5.75 (146.1)	YS2048	LT2048S or F	EZB2048R	EZT2048S or F
Main lugs or main breaker with 225 A through-feed lugs	PDG2xF, PDG2xG, PDG2xM, PDD2xF, PDD2xG, PDD2xM (V)	18	48.00 (1219.2)	20.00 (508.0)	5.75 (146.1)	YS2048	LT2048S or F	EZB2048R	EZT2048S or F
		30	48.00 (1219.2)	20.00 (508.0)	5.75 (146.1)	YS2048	LT2048S or F	EZB2048R	EZT2048S or F
		42	60.00 (1524.0)	20.00 (508.0)	5.75 (146.1)	YS2060	LT2060S or F	EZB2060R	EZT2060S or F
400 A									
Main lugs or main breaker	PDG3xG, PDG3xM, PDG3xP, LHH (V)	18	60.00 (1524.0)	20.00 (508.0)	5.75 (146.1)	YS2060	LT2060S or F	EZB2060R	EZT2060S or F
		30	60.00 (1524.0)	20.00 (508.0)	5.75 (146.1)	YS2060	LT2060S or F	EZB2060R	EZT2060S or F
		42	72.00 (1828.8)	20.00 (508.0)	5.75 (146.1)	YS2072	LT2072S or F	EZB2072R	EZT2072S or F
Main lugs or main breaker with 225 A through-feed lugs	PDG3xG, PDG3xM, PDG3xP, LHH (V)	18	60.00 (1524.0)	20.00 (508.0)	5.75 (146.1)	YS2060	LT2060S or F	EZB2060R	EZT2060S or F
		30	72.00 (1828.8)	20.00 (508.0)	5.75 (146.1)	YS2072	LT2072S or F	EZB2072R	EZT2072S or F
		42	72.00 (1828.8)	20.00 (508.0)	5.75 (146.1)	YS2072	LT2072S or F	EZB2072R	EZT2072S or F
Main lugs or main breaker with 400 A through-feed lugs	PDG3xG, PDG3xM, PDG3xP, LHH (V)	18	72.00 (1828.8)	20.00 (508.0)	5.75 (146.1)	YS2072	LT2072S or F	EZB2072R	EZT2072S or F
		30	90.00 (2286.0)	20.00 (508.0)	5.75 (146.1)	YS2090	LT2090S or F	EZB2090R	EZT2090S or F
		42	90.00 (2286.0)	20.00 (508.0)	5.75 (146.1)	YS2090	LT2090S or F	EZB2090R	EZT2090S or F

Note

① Smaller panelboard box sizes are available if required. Contact Eaton for application information.

Type PRL2X-LX, Column Type



3

Type PRL2X-LX

Product Description

- 480Y/277 Vac maximum (125 Vdc)
- Three-phase four-wire, three-phase three-wire, single-phase three-wire, single-phase two-wire
- 225 A maximum mains
- 100 A maximum branch breakers
- Bolt-on branch breakers
- Factory assembled
- Refer to Refer to **Page V2-T3-7** for additional information

Application Description

- Lighting branch panelboard
- Column mounting width
- Fully rated or series rated
- Interrupting ratings up to 200 kA symmetrical
- See **Pages V2-T3-7** through **V2-T3-17** for additional information

Contents

<i>Description</i>	<i>Page</i>
Product Description	V2-T3-7
Application Description	V2-T3-8
Standards and Certifications	V2-T3-10
Power Xpert Release Trip Unit for Molded Case Circuit Breakers	V2-T3-11
Technical Data and Specifications	V2-T3-12
Type PRL1X	V2-T3-18
Type PRL1XF	V2-T3-22
Type PRL1X-LX	V2-T3-25
Type PRL2X	V2-T3-29
Type PRL2XF	V2-T3-33
Type PRL2X-LX Product Selection	V2-T3-37
Box Sizing and Selection	V2-T3-38
Retrofit Panelboard	V2-T3-40
Type PRL3E	V2-T3-48
Type PRL3X	V2-T3-52
Type PRL3XF	V2-T3-56
Type PRL3FQS	V2-T3-59
Type PRL4X	V2-T3-62
Type PRL4DX	V2-T3-72

Standards and Certifications

- UL 67, UL 50
- Federal Specification W-P-115c
- Refer to **Page V2-T3-10** for additional information



Product Selection

Type PRL2X-LX



PRL2X-LX

Ampere Rating	Interrupting Rating (kA Symmetrical)			Breaker Type
	240 Vac	480Y/277 Vac	125/250 Vdc	
Main Lug Only				
100	—	—	—	—
225	—	—	—	—
Main Breaker				
100	65	14	14	GHB
100	35	25	10	PDG2xF
100	65	35	10	PDG2xG
100	100	65	22	PDG2xM
100	200	100	22	PDG2xP
225	65	—	—	PDD2xG
225	65	35	10	PDG2xG
225	100	65	22	PDG2xM
225	200	100	22	PDG2xP

Branch Circuit Breakers—PRL2X-LX

Ampere Rating	Interrupting Rating (kA Symmetrical)			Breaker Type
	240 Vac ①	480Y/277 Vac	125/250 Vdc	
15–30	65	14	—	GHQ ②
15–20	65	14	14	GHB ②
25–60	65	14	14	GHB ②
70–100	65	14	14	GHB ②
15–30	65	25	—	HGHB ②
15–20	65	14	—	GHQRD
15–20	65	14	—	GHQRSP ③
15–60	—	14	—	GHBGFEF ②④
Provision	—	—	—	—

Pull Box With Extension Trough

Includes pull box with trough extension. For additional trough extensions, refer to table below.

Description	Catalog Number
Pullbox with 36-inch trough	XCTXB036
Pullbox with 48-inch trough	XCTXB048
Pullbox with 60-inch trough	XCTXB060
Pullbox with 72-inch trough	XCTXB072
Pullbox with 84-inch trough	XCTXB084

Neutral Bars

When column-type panelboards are furnished with trough extensions and pull box, the neutral bar will be placed in the pull box unless otherwise specified.

When troughs and pull box are not furnished, the neutral bar will be located on the panel at the same end as the main.

Additional Trough Extensions

Width and depth are the same as the panelboard.

Length Inches (mm)	Catalog Number
36.00 (914.4)	CTXB036
48.00 (1219.2)	CTXB048
60.00 (1524.0)	CTXB060
72.00 (1828.8)	CTXB072
84.00 (2133.6)	CTXB084

Notes

- ① Interrupting ratings in this column are applicable to 120 Vac for single-pole breakers.
- ② At 480 V, must be used on 480Y/277 V grounded wye systems only.
- ③ Remote operated circuit breaker.
- ④ GFP for 30 mA equipment protection. Requires two pole spaces.

Box Sizing and Selection

Approximate Dimensions in Inches (mm)

Assembled Circuit Breaker Panelboards

Box dimensions, box and trim catalog numbers for standard column-type panelboards listed are available from tables on **Page V2-T3-39**.

Instructions

- Using description of the required panelboard, select the rating and type of main required.
 - 100 A panelboards—**Page V2-T3-39**.
 - 225 A panelboards—**Page V2-T3-39**.
- Count the total number of branch circuit poles, including provisions, required in the panelboard. Do not count main breaker poles. Convert two- or three-pole branch breaker to single poles, i.e., three-pole breaker, count as three poles.
Determine sub-feed breaker or through-feed lug requirements.
- Select the panelboard main ampere rating from tables on **Page V2-T3-39**.
- Panelboard Type from first column, main breaker Frame and Designation, if applicable from second column, and sub-feed breaker Frame and Designation, if applicable, from the third column.
- From Step #2, determine the number of branch circuits in Column 4.
- Read box dimensions, box and trim catalog numbers across columns to the right. All panels are surface mounted.

Cabinets

Boxes and trims are code-gauge steel, ANSI-61 light gray painted finish.

Boxes are furnished without knockouts. Standard depth is 6.00 inches (152.4 mm). Standard width is 8.63 inches (219.1 mm).

Top and Bottom Gutters

4.50 inches (114.3 mm) minimum.

Left Side Gutter

3.31 inches (84.2 mm) minimum.

Pull Box

Pull box is furnished without knockouts. Standard dimensions:

Pull Box Dimensions

Height	Width	Depth
12.00 (304.8)	16.00 (406.4)	6.00 (152.4)

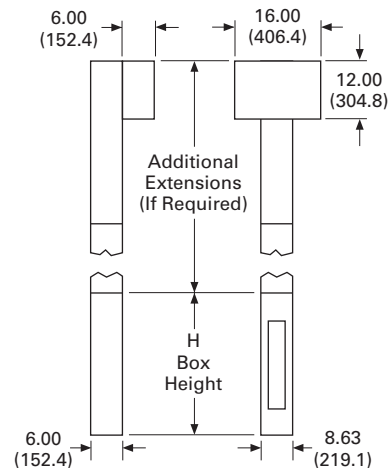
PRL2X-LX Trough Extension**Trough Extension**

When extension troughs are used, Section 376 of the National Electrical Code should be observed: 376. Number of Conductors. Wireways shall not contain more than 30 conductors at any cross section, unless the conductors are for signal circuits or are control conductors between a motor and its starter and used only for starting duty. The sum of the cross-sectional areas of all contained conductors at any cross section of a wireway shall not exceed 20% of the interior cross-sectional area of the wireway.

Approximate Dimensions in Inches (mm)

100 A Maximum PRL2X-LX Column-Type Panelboard Sizing

Panelboard Types	Main Breaker Types Mounting: (H) = Horizontal (V) = Vertical	Sub-Feed Breaker Types Vertical Mounting	Maximum Number of Branch Circuits Including Provisions	Box Dimensions			Box Catalog Number	Trim Catalog Number ^①
				Height	Width	Depth		
Main breaker	GHB (H)	—	27	69.00 (1752.6)	8.63 (219.2)	6.00 (152.4)	YSC969	LTC969S
		—	39	81.00 (2057.7)	8.63 (219.2)	6.00 (152.4)	YSC981	LTC981S
Main lugs or main breaker	PDG2xF, PDG2xG PDG2xM, PDG2xP (V)	—	30	69.00 (1752.6)	8.63 (219.2)	6.00 (152.4)	YSC969	LTC969S
		—	42	81.00 (2057.7)	8.63 (219.2)	6.00 (152.4)	YSC981	LTC981S
Main lugs or main breaker with 100 A through-feed lugs or sub-feed breaker	PDG2xF, PDG2xG PDG2xM, PDG2xP (V)	PDG2xF, PDG2xG, PDG2xM	30	78.00 (1981.2)	8.63 (219.2)	6.00 (152.4)	YSC978	LTC978S
		—	42	90.00 (2286.0)	8.63 (219.2)	6.00 (152.4)	YSC990	LTC990S

225 A Maximum PRL2X-LX Column-Type Panelboard Sizing

Panelboard Types	Main Breaker Types Vertical Mounting	Sub-Feed Breaker Types	Maximum Number of Branch Circuits Including Provisions	Box Dimensions			Box Catalog Number	Trim Catalog Number ^①
				Height	Width	Depth		
Main lugs or main breaker	PDD2xG, PDG2xG PDG2xM, PDG2xP	—	30	69.00 (1752.6)	8.63 (219.2)	6.00 (152.4)	YSC969	LTC969S
		—	42	81.00 (2057.7)	8.63 (219.2)	6.00 (152.4)	YSC981	LTC981S
Main lugs or main breaker with 225 A through-feed lugs or sub-feed breaker	PDD2xG, PDG2xG PDG2xM, PDG2xP	PDG2xF, PDG2xG, PDG2xM,	30	78.00 (1981.2)	8.63 (219.2)	6.00 (152.4)	YSC978	LTC978S
		PDD2xG, PDD2xM	42	90.00 (2286.0)	8.63 (219.2)	6.00 (152.4)	YSC990	LTC990S

Note

^① Add suffix B to trim catalog number for bottom fed panelboards (i.e., LTC969SB).

Retrofit Panelboard



3

Contents

<i>Description</i>	<i>Page</i>
Product Description	V2-T3-7
Application Description	V2-T3-8
Standards and Certifications	V2-T3-10
Power Xpert Release Trip Unit for Molded Case Circuit Breakers	V2-T3-11
Technical Data and Specifications	V2-T3-12
Type PRL1X	V2-T3-18
Type PRL1XF	V2-T3-22
Type PRL1X-LX	V2-T3-25
Type PRL2X	V2-T3-29
Type PRL2XF	V2-T3-33
Type PRL2X-LX	V2-T3-36
Retrofit Panelboard	V2-T3-40
Catalog Number Selection	V2-T3-41
Product Selection	V2-T3-42
Application Guidelines	V2-T3-44
Custom Trim Selection	V2-T3-45
Options and Accessories	V2-T3-47
Type PRL3E	V2-T3-48
Type PRL3X	V2-T3-52
Type PRL3XF	V2-T3-56
Type PRL3FQS	V2-T3-59
Type PRL4X	V2-T3-62
Type PRL4DX	V2-T3-72

Retrofit Panelboard

Product Description

- PRL1RX—240 Vac;
PRL2RX—480Y/277 V
- Single-phase three-wire
or single-phase two-wire
- Three-phase three-wire
or three-phase four-wire
- 225 A maximum
- 100 A maximum branch
breakers
- Standard PRL1RX fits
existing box depths from
4.50–6.00 inches deep;
Standard PRL2RX fits
existing box depths from
4.75–6.00 inches deep
(without additional
accessories)
- Integrally mounted neutral
assembly
- Grounding lug included
- Neutral and ground
convertible from left-right
- Bolt-on branch breakers
- Factory assembled

Application Description

- Lighting branch panelboard
- Fully rated or series rated
- Interrupting capacities to
100 kA symmetrical
- Suitable for use as
Service Entrance
Equipment where
specified on the order

Standards and Certifications

- UL 67
- Federal Specification
W-P-115c
- CSA C22.2 No. 29



Catalog Number Selection

Retrofit Panelboard

3

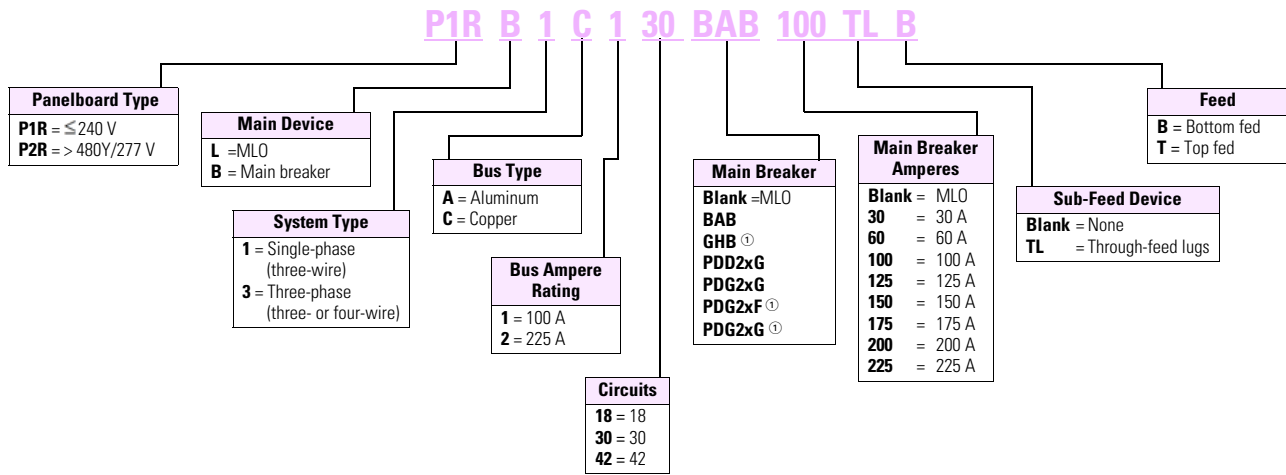

Trim Selection

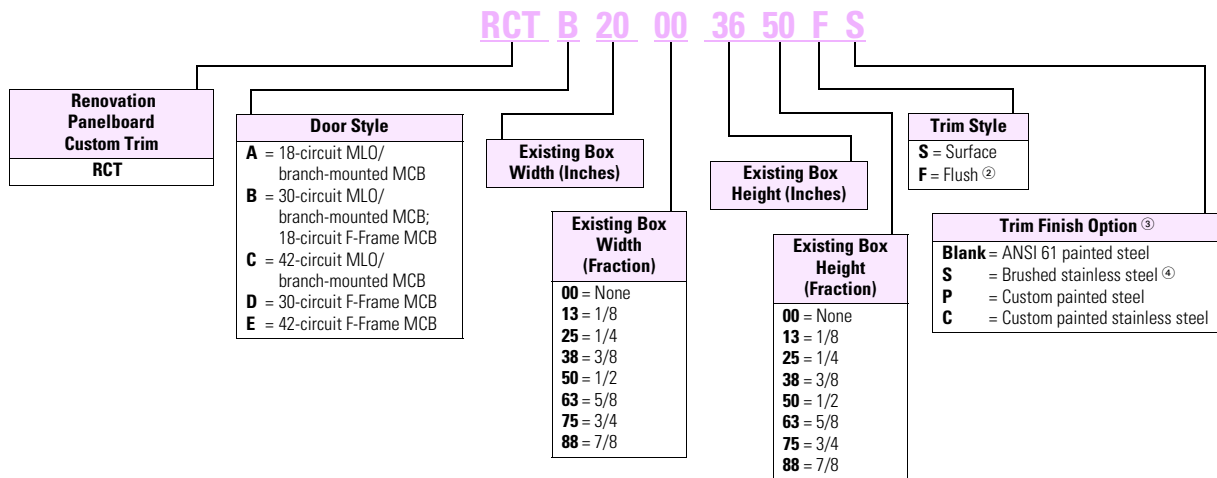

Notes

- ① P2R only.
- ② Flush trims include 1-inch overlap per side.
- ③ Standard trim includes 12-gauge steel painted ANSI 61 grey.
- ④ Stainless trims provided as 304 standard. Optional 316 available.

Product Selection

Retrofit Panelboard

3



P1R—Aluminum Bus, Single-Phase or Three-Phase ①

Ampere Rating	Number of Circuits	Interrupting Rating (kA Sym.) 240 Vac	Main Breaker Type	Single-Phase Three-Wire— Single-Phase Two-Wire	Three-Phase Three-Wire— Three-Phase Four-Wire
				Catalog Number	Catalog Number
Main Lug Only					
100	18	—	MLO	P1RL1A118	P1RL3A118
	30	—	MLO	P1RL1A130	P1RL3A130
	42	—	MLO	P1RL1A142	P1RL3A142
225	18	—	MLO	P1RL1A218	P1RL3A218
	30	—	MLO	P1RL1A230	P1RL3A230
	42	—	MLO	P1RL1A242	P1RL3A242
Main Breaker					
100	18	10	BAB ②	P1RB1A118BAB ③	P1RB3A118BAB ③
	30	10	BAB ②	P1RB1A130BAB ③	P1RB3A130BAB ③
	42	10	BAB ②	P1RB1A142BAB ③	P1RB3A142BAB ③
	18	35	PDG2xF	P1RB1A118EHD ③	P1RB3A118EHD ③
	30	35	PDG2xF	P1RB1A130EHD ③	P1RB3A130EHD ③
	42	35	PDG2xF	P1RB1A142EHD ③	P1RB3A142EHD ③
	18	22	QBHW ②	P1RB1A118QBHW ③	P1RB3A118QBHW ③
	30	22	QBHW ②	P1RB1A130QBHW ③	P1RB3A130QBHW ③
	42	22	QBHW ②	P1RB1A142QBHW ③	P1RB3A142QBHW ③
	18	65	PDD2xG	P1RB1A118ED ③	P1RB3A118ED ③
	30	65	PDD2xG	P1RB1A130ED ③	P1RB3A130ED ③
	42	65	PDD2xG	P1RB1A142ED ③	P1RB3A142ED ③
	18	100	PDD2xM	P1RB1A118EDH ③	P1RB3A118EDH ③
	30	100	PDD2xM	P1RB1A130EDH ③	P1RB3A130EDH ③
	42	100	PDD2xM	P1RB1A142EDH ③	P1RB3A142EDH ③
225	18	65	PDD2xG	P1RB1A218ED ③	P1RB3A218ED ③
	30	65	PDD2xG	P1RB1A230ED ③	P1RB3A230ED ③
	42	65	PDD2xG	P1RB1A242ED ③	P1RB3A242ED ③
	18	100	PDD2xM	P1RB1A218EDH ③	P1RB3A218EDH ③
	30	100	PDD2xM	P1RB1A230EDH ③	P1RB3A230EDH ③
	42	100	PDD2xM	P1RB1A242EDH ③	P1RB3A242EDH ③

Notes

① Standard trim included. Select standard trim from **Page V2-T3-44**. Custom trims are available for an additional charge. Contact your local Satellite for more information about custom trims.

② BAB and QBHW main devices consume available circuit space positions. (Two circuits for single-phase; three circuits for three-phase.)

③ Add main breaker ampere rating suffix. May NOT exceed main bus rating.

A neutral assembly is included with the base chassis. For single-phase two-wire systems or for three-phase, three-wire systems, do not connect.

Sum of branch circuit amperes not to exceed 140 A.

Retrofit Panelboard

P2R—Aluminum Bus, Three-Phase



Ampere Rating	Number of Circuits	Main Breaker Interrupting Rating (kA Sym.) 480Y/277 Vac	Main Breaker Type	Three-Phase Four-Wire Catalog Number
Main Lug Only				
100	18	—	MLO	P2RL3A118
	30	—	MLO	P2RL3A130
	42	—	MLO	P2RL3A142
225	18	—	MLO	P2RL3A218
	30	—	MLO	P2RL3A230
	42	—	MLO	P2RL3A242
Main Breaker				
100	18	14	GHB ①	P2RB3A118GHB ②
	30	14	GHB ①	P2RB3A130GHB ②
	42	14	GHB ①	P2RB3A142GHB ②
	18	25	PDG2xF	P2RB3A118EHD ②
	30	25	PDG2xF	P2RB3A130EHD ②
	42	25	PDG2xF	P2RB3A142EHD ②
	18	35	PDG2xG	P2RB3A118FD ②
	30	35	PDG2xG	P2RB3A130FD ②
	42	35	PDG2xG	P2RB3A142FD ②
	18	65	PDG2xM	P2RB3A118HFD ②
	30	65	PDG2xM	P2RB3A130HFD ②
	42	65	PDG2xM	P2RB3A142HFD ②
	18	100	PDG2xP	P2RB3A118FDC ②
	30	100	PDG2xP	P2RB3A130FDC ②
	42	100	PDG2xP	P2RB3A142FDC ②
225	18	35	PDG2xG	P2RB3A218FD ②
	30	35	PDG2xG	P2RB3A230FD ②
	42	35	PDG2xG	P2RB3A242FD ②
	18	65	PDG2xM	P2RB3A218HFD ②
	30	65	PDG2xM	P2RB3A230HFD ②
	42	65	PDG2xM	P2RB3A242HFD ②
	18	100	PDG2xP	P2RB3A218FDC ②
	30	100	PDG2xP	P2RB3A230FDC ②
	42	100	PDG2xP	P2RB3A242FDC ②

Notes

① GHB main devices consume available circuit space positions. (Three circuits for three-phase.)

② Add main breaker ampere rating suffix. May NOT exceed main bus rating.

A neutral assembly is included with the base chassis.

Application Guidelines

Instructions

- In order to meet minimum wire bending space requirements and to ensure ease of installation, minimum enclosure space dimensions have been defined for each chassis. In order to ensure a proper fit, every panelboard to be renovated must be carefully surveyed prior to installation
- Determine the electrical requirements of the panelboard to be renovated (i.e., main breaker or main lugs, amperes, interrupting rating, circuit space, branch breakers, accessories)
 - Using the electrical requirement data, select a base chassis and any required breakers, options and accessories
 - Page V2-T3-46** provides the minimum dimensions of the enclosure, in which each base chassis may be installed. These dimensions assume that the chassis is mounted in the center of the existing box, both vertically and horizontally. Where site conditions require the chassis to be offset from this centrally mounted position, it is the installer's responsibility to ensure wire bending space and electrical clearance requirements are met
- Page V2-T3-46** provides a "Trim Door Size Code." Using this code, select a standard trim from the tables that will fit the outside dimensions of the existing box. Refer to **Page V2-T3-45** to define non-standard trim requirements

Standard Trim Selection—20-Inch (508.0 mm) Wide Enclosure

Trim Door Size Code	Enclosure Height—Inches (mm)	Surface Type		Flush Type	
		Catalog Number	Trim Dimensions—Inches (mm) Height Width	Catalog Number	Trim Dimensions—Inches (mm) Height Width
A	24.00 (609.6)	RTA2024	24.00 (609.6) 20.00 (508.0)	RTA2226	26.00 (660.4) 22.00 (558.8)
A	30.00 (762.0)	RTA2030	30.00 (762.0) 20.00 (508.0)	RTA2232	32.00 (812.8) 22.00 (558.8)
A	36.00 (914.4)	RTA2036	36.00 (914.4) 20.00 (508.0)	RTA2238	38.00 (965.2) 22.00 (558.8)
B	30.00 (762.0)	RTB2030	30.00 (762.0) 20.00 (508.0)	RTB2232	32.00 (812.8) 22.00 (558.8)
B	36.00 (914.4)	RTB2036	36.00 (914.4) 20.00 (508.0)	RTB2238	38.00 (965.2) 22.00 (558.8)
B	42.00 (1066.8)	RTB2042	42.00 (1066.8) 20.00 (508.0)	RTB2244	44.00 (1117.6) 22.00 (558.8)
C	36.00 (914.4)	RTC2036	36.00 (914.4) 20.00 (508.0)	RTC2238	38.00 (965.2) 22.00 (558.8)
C	42.00 (1066.8)	RTC2042	42.00 (1066.8) 20.00 (508.0)	RTC2244	44.00 (1117.6) 22.00 (558.8)
C	48.00 (1219.2)	RTC2048	48.00 (1219.2) 20.00 (508.0)	RTC2250	50.00 (1270.0) 22.00 (558.8)
D	30.00 (762.0)	RTD2030	30.00 (762.0) 20.00 (508.0)	RTD2232	32.00 (812.8) 22.00 (558.8)
D	36.00 (914.4)	RTD2036	36.00 (914.4) 20.00 (508.0)	RTD2238	38.00 (965.2) 22.00 (558.8)
D	42.00 (1066.8)	RTD2042	42.00 (1066.8) 20.00 (508.0)	RTD2244	44.00 (1117.6) 22.00 (558.8)
E	36.00 (914.4)	RTE2036	36.00 (914.4) 20.00 (508.0)	RTE2238	38.00 (965.2) 22.00 (558.8)
E	42.00 (1066.8)	RTE2042	42.00 (1066.8) 20.00 (508.0)	RTE2244	44.00 (1117.6) 22.00 (558.8)
E	48.00 (1219.2)	RTE2048	48.00 (1219.2) 20.00 (508.0)	RTE2250	50.00 (1270.0) 22.00 (558.8)

Standard Trim Selection—14-Inch (355.6 mm) Wide Enclosure

Trim Door Size Code	Enclosure Height—Inches (mm)	Surface Type		Flush Type	
		Catalog Number	Trim Dimensions—Inches (mm) Height Width	Catalog Number	Trim Dimensions—Inches (mm) Height Width
A	24.00 (609.6)	RTA1424	24.00 (609.6) 14.00 (355.6)	RTA1626	26.00 (660.4) 16.00 (406.4)
A	30.00 (762.0)	RTA1430	30.00 (762.0) 14.00 (355.6)	RTA1632	32.00 (812.8) 16.00 (406.4)
A	36.00 (914.4)	RTA1436	36.00 (914.4) 14.00 (355.6)	RTA1638	38.00 (965.2) 16.00 (406.4)
B	30.00 (762.0)	RTB1430	30.00 (762.0) 14.00 (355.6)	RTB1632	32.00 (812.8) 16.00 (406.4)
B	36.00 (914.4)	RTB1436	36.00 (914.4) 14.00 (355.6)	RTB1638	38.00 (965.2) 16.00 (406.4)
B	42.00 (1066.8)	RTB1442	42.00 (1066.8) 14.00 (355.6)	RTB1644	44.00 (1117.6) 16.00 (406.4)
C	36.00 (914.4)	RTC1436	36.00 (914.4) 14.00 (355.6)	RTC1638	38.00 (965.2) 16.00 (406.4)
C	42.00 (1066.8)	RTC1442	42.00 (1066.8) 14.00 (355.6)	RTC1644	44.00 (1117.6) 16.00 (406.4)
C	48.00 (1219.2)	RTC1448	48.00 (1219.2) 14.00 (355.6)	RTC1650	50.00 (1270.0) 16.00 (406.4)
D	30.00 (762.0)	RTD1430	30.00 (762.0) 14.00 (355.6)	RTD1632	32.00 (812.8) 16.00 (406.4)
D	36.00 (914.4)	RTD1436	36.00 (914.4) 14.00 (355.6)	RTD1638	38.00 (965.2) 16.00 (406.4)
D	42.00 (1066.8)	RTD1442	42.00 (1066.8) 14.00 (355.6)	RTD1644	44.00 (1117.6) 16.00 (406.4)
E	36.00 (914.4)	RTE1436	36.00 (914.4) 14.00 (355.6)	RTE1638	38.00 (965.2) 16.00 (406.4)
E	42.00 (1066.8)	RTE1442	42.00 (1066.8) 14.00 (355.6)	RTE1644	44.00 (1117.6) 16.00 (406.4)
E	48.00 (1219.2)	RTE1448	48.00 (1219.2) 14.00 (355.6)	RTE1650	50.00 (1270.0) 16.00 (406.4)

Custom Trim Selection

Instructions

In order to accommodate instances where the standard trims do not suit an installation, custom-sized trims may be ordered. Since the trim mounts to the retrofit chassis, and not the existing enclosure, custom trims can solve many problems encountered with differing enclosure sizes and configurations. Contact your local Satellite plant to ensure manufacturability and determine lead time required.

Outer Dimensions

The outer dimensions are the overall OUTSIDE dimensions of the trim. In surface-mounted applications, this is usually the same as the outside dimensions of the enclosure to be renovated. For flush-mounted applications, an additional amount of trim material extends beyond the outer edge of the box, in order to cover any gap between the wall material and the box. Extending the outer dimensions can cover larger than normal wall gaps or imperfections that may be encountered.

3.3

Panelboards and Lighting Control

Pow-R-Line Xpert Panelboards

Minimum Enclosure Sizing

Ampere Rating	Number of Circuits	Main Device Type	Trim Door Size Code	Minimum Enclosure Dimensions—Inches (mm)		
				Height	Width	Depth
Main Lug Only						
100	18	MLO	A	19.50 (495.3)	14.00 (355.6)	4.50 (114.3)
	30	MLO	B	26.50 (673.1)	14.00 (355.6)	4.50 (114.3)
	42	MLO	C	33.50 (850.9)	14.00 (355.6)	4.50 (114.3)
225	18	MLO	A	19.50 (495.3)	14.00 (355.6)	4.50 (114.3)
	30	MLO	B	26.50 (673.1)	14.00 (355.6)	4.50 (114.3)
	42	MLO	C	33.50 (850.9)	14.00 (355.6)	4.50 (114.3)
Main Breaker						
100	18	BAB, GHB	A	19.50 (495.3)	14.00 (355.6)	4.50 (114.3)
	30	BAB, GHB	B	26.50 (673.1)	14.00 (355.6)	4.50 (114.3)
	42	BAB, GHB	C	33.50 (850.9)	14.00 (355.6)	4.50 (114.3)
	18	PDG2xF	B	30.00 (762.0)	14.00 (355.6)	4.50 (114.3)
	30	PDG2xF	D	36.00 (914.4)	14.00 (355.6)	4.50 (114.3)
	42	PDG2xF	E	42.00 (1066.8)	14.00 (355.6)	4.50 (114.3)
	18	QBHW	A	19.50 (195.3)	14.00 (355.6)	4.50 (114.3)
	30	QBHW	B	26.50 (673.1)	14.00 (355.6)	4.50 (114.3)
	42	QBHW	C	33.50 (850.9)	14.00 (355.6)	4.50 (114.3)
	18	PDD2xG, PDG2xG	B	30.00 (762.0)	14.00 (355.6)	4.50 (114.3)
	30	PDD2xG, PDG2xG	D	36.00 (914.4)	14.00 (355.6)	4.50 (114.3)
	42	PDD2xG, PDG2xG	E	42.00 (1066.8)	14.00 (355.6)	4.50 (114.3)
	18	PDD2xM, PDG2xM, PDG2xP	B	30.00 (762.0)	14.00 (355.6)	4.50 (114.3)
	30	PDD2xM, PDG2xM, PDG2xP	D	36.00 (914.4)	14.00 (355.6)	4.50 (114.3)
	42	PDD2xM, PDG2xM, PDG2xP	E	42.00 (1066.8)	14.00 (355.6)	4.50 (114.3)
225	18	PDD2xG, PDG2xG	B	30.00 (762.0)	14.00 (355.6)	4.50 (114.3)
	30	PDD2xG, PDG2xG	D	36.00 (914.4)	14.00 (355.6)	4.50 (114.3)
	42	PDD2xG, PDG2xG	E	42.00 (1066.8)	14.00 (355.6)	4.50 (114.3)
	18	PDD2xM, PDG2xM, PDG2xP	B	30.00 (762.0)	14.00 (355.6)	4.50 (114.3)
	30	PDD2xM, PDG2xM, PDG2xP	D	36.00 (914.4)	14.00 (355.6)	4.50 (114.3)
	42	PDD2xM, PDG2xM, PDG2xP	E	42.00 (1066.8)	14.00 (355.6)	4.50 (114.3)

Options and Accessories

Branch Circuit Breakers—P1R

Ampere Rating	Interrupting Rating (kA Sym.) 240 Vac ^①	Breaker Type
15–60	10	BAB
70	10	BAB
80–100	10	BAB
15–30	10	BABRP ^③
15–30	10	BABRSP ^③
15–50 ^②	10	QBGF ^④
15–50 ^②	10	QBGFEP ^⑤
15–20	10	QBCAF ^⑥
15–60	10	BAB-D ^⑦
15–30	10	BAB-C ^⑧
15–60	22	QBHW
70	22	QBHW
80–100	22	QBHW
15–30	22	QBHGF
15–30	22	QBHGFEP
15–20	22	QBHCAF ^⑥
Provision	—	—

Branch Breakers—P2R

Ampere Rating	Interrupting Rating (kA Sym.) 480Y/277 Vac	Breaker Type Rating (kA Sym.)
15–30	14	GHQ
15–20	14	GHB
25–60	14	GHB
70–100	14	GHB
15–60	14	GHBGFEP ^⑨
15–20	14	GHB-HID ^⑩
15–30	25	HGHB
Provision	—	—

Copper Main Bus Adder

Main Bus Ampere Rating	Catalog Number
100	Ⓜ
225	Ⓜ

Copper Terminal Ground Bar for Copper Cable Only

Catalog Number
P1RGBC

Insulated/Isolated Ground Bus (Separately Mounted)

Aluminum Catalog Number	Copper Catalog Number
P1RGKA	P1RNKC

Neutral Kit (Separately Mounted)[Ⓜ]

Number of Termination Points	Aluminum Catalog Number	Copper Catalog Number
18	P1RNKA18	P1RNKC18
30	P1RNKA30	P1RNKC30
42	P1RNKA42	P1RNKC42

Depth Adder Kits[Ⓜ]

Standard Pow-R-Line 1R—Fits 4.50 to 6.00 inches
Standard Pow-R-Line 2R—Fits 4.75 to 6.00 inches

Accessory/Kits	For Use With Box Depth—Inches (mm)	Part Number
1.50 depth adder	6.00–7.50 (152.4–190.5)	P1RDA15
3.00 depth adder	7.50–9.00 (190.5–228.6)	P1RDA30
4.50 depth adder	9.00–10.50 (228.6–266.7)	P1RDA45
6.00 depth adder	10.50–12.00 (266.7–304.8)	P1RDA60

Box Collar Kits[Ⓜ]

Accessory/Kits	For Use With Box Depth—Inches (mm)	Part Number
Box collar	3.50–4.50 (88.9–114.3)	P1RBC10

Notes

- ① Single-pole breakers are rated 120 Vac maximum.
- ② 50 A devices available as two-pole only.
- ③ Remote operated circuit breaker.
- ④ GFCI for 5 mA personnel protection.
- ⑤ GFP for 30 mA equipment protection.
- ⑥ Arc fault circuit breaker.
- ⑦ HID (High Intensity Discharge) rated breaker.
- ⑧ Switching neutral breaker. Single-pole device requires two pole spaces; two-pole device requires three pole spaces.
- ⑨ GFP for 30 mA equipment protection. Requires two-pole spaces. 277 Vac only.
- ⑩ HID (High Intensity Discharge) rated breaker.
- Ⓜ To convert base chassis catalog number from aluminum main bus to copper main bus, change the 6th digit of the aluminum base chassis catalog number to “C” (e.g., P1RL1A1-42 becomes P1RL1C1-42).
- Ⓜ Each base chassis includes a neutral bar that contains one connection point for every circuit space available. Use this kit when additional connection points are required or the neutral must be separately mounted to meet existing cable locations.
- Ⓜ Allows for panel to be used in boxes deeper than 6.00 inches.
- Ⓜ Allows for panel to be used in boxes less than 4.50 inches.

Type PRL3E



Contents

<i>Description</i>	<i>Page</i>
Product Description	V2-T3-7
Application Description	V2-T3-8
Standards and Certifications	V2-T3-10
Power Xpert Release Trip Unit for Molded Case Circuit Breakers	V2-T3-11
Technical Data and Specifications	V2-T3-12
Type PRL1X	V2-T3-18
Type PRL1XF	V2-T3-22
Type PRL1X-LX	V2-T3-25
Type PRL2X	V2-T3-29
Type PRL2XF	V2-T3-33
Type PRL2X-LX	V2-T3-36
Retrofit Panelboard	V2-T3-40
Type PRL3E	V2-T3-48
Product Selection	V2-T3-49
Box Sizing and Selection	V2-T3-50
Type PRL3X	V2-T3-52
Type PRL3XF	V2-T3-56
Type PRL3FQS	V2-T3-59
Type PRL4X	V2-T3-62
Type PRL4DX	V2-T3-72

Type PRL3E

Product Description

- 480 Vac maximum (250 Vdc)
- Three-phase four-wire, three-phase three-wire, single-phase three-wire, single-phase two-wire
- 600 A main lugs
- 600 A main breaker
- 125 A maximum branch breakers
- Bolt-on branch breakers
- Factory assembled
- Refer to **Page V2-T3-7** for additional information

Application Description

- Lighting and appliance branch panelboard
- Fully rated or series rated
- Interrupting ratings up to 200 kA symmetrical
- Suitable for use as Service Entrance Equipment, when specified on the order
- See **Pages V2-T3-7** through **V2-T3-17** for additional information

Standards and Certifications

- UL 67, UL 50
- CSA C22.2 No. 29
- Federal Specification W-P-115c
- Refer to **Page V2-T3-10** for additional information



Product Selection

Type PRL3E



PRL3E

Ampere Rating	Breaker Type	Interrupting Rating (kA Symmetrical)		
		240 Vac	480 Vac	250 Vdc
Main Lug Only				
100	—	—	—	—
250	—	—	—	—
400	—	—	—	—
600	—	—	—	—
Main Breaker				
125	EGB	35	18	10
125	EGS	100	35	35
125	EGH	200	65	42
225	PDD2xF	35	—	—
225	PDD2xG	65	—	—
225	PDD2xM	100	—	—
225	PDD2xP	200	—	—
225	PDG2xG	65	35	10
225	PDG2xM	100	65	22
225	PDG2xP	200	100	22
400	PDD3xG	65	—	—
400	PDG3xG ^①	65	35	10
400	PDG3xM ^①	100	65	22
400	LHH	100	65	—
400	PDG3xP ^①	200	100	22
600	PDG3xG ^①	65	35	22
600	PDG3xM ^①	100	65	22

Note

^① The 400 A frame must use trip units of ratings 100–400, while the 600 A frame must use trip units of ratings 500, 600 or designated by H, such as H250. The H as the leading character of the ampacity indicates a high instantaneous version of the breaker for coordination purposes. H ratings must use 600 A frame.

Box Sizing and Selection

Approximate Dimensions in Inches (mm)

Assembled Circuit Breaker Panelboards and Lighting Controls

Box dimensions and box and trim catalog numbers for all standard panelboard types are found on **Page V2-T3-51**.

3

Instructions

1. Using description of the required panelboard, select the rating and type of main required.
2. Count the total number of branch circuit poles, including provisions, required in the panelboard. Do not count main breaker poles. Convert two- or three-pole branch breaker to single-poles, i.e., three-pole breaker, count as three poles. Determine sub-feed breaker or through-feed lug requirements.
3. Select the main ampere rating section from **Page V2-T3-51**.
4. Select panelboard type from first column, main breaker frame, if applicable, from second column, and sub-feed breaker frame, if applicable, from the third column.
5. From Step #2, determine the number of branch circuits in Column 4.
6. Read box dimensions, box and trim catalog numbers across columns to the right. Specify surface or flush mounting on the order.

Cabinets

Fronts are code-gauge steel, ANSI-61 light gray painted finish.

Boxes are code-gauge galvanized steel without knockouts. Standard depth is 5-3/4 inches (146.1 mm). Standard width is 20 inches (508.0 mm). An optional 28-inch (711.2 mm) wide box is available.

Top and Bottom Gutters

5-1/2 inches (139.7 mm) minimum.

Approximate Dimensions in Inches (mm)

PRL3E Panelboard Sizing

Panelboard Types	Main Breaker Types and Mounting Position (H) = Horizontal (V) = Vertical	Sub-Feed Breaker Types and Mounting Position (H) = Horizontal (V) = Vertical	Maximum No. of Branch Circuits Including Provisions	Box Dimensions ^①			YS Box Catalog Number	LT Trim Catalog Number	EZ Box Catalog Number	EZ Trim Catalog Number
				Height	Width	Depth				
125 A										
Main breaker	EG, EGS, EGH (H)	—	12	36.00 (914.4)	20.00 (508.0)	5.75 (146.1)	YS2036	LT2036S or F	EZB2036R	EZT2036S or F
		—	24	36.00 (914.4)	20.00 (508.0)	5.75 (146.1)	YS2036	LT2036S or F	EZB2036R	EZT2036S or F
		—	36	36.00 (914.4)	20.00 (508.0)	5.75 (146.1)	YS2036	LT2036S or F	EZB2036R	EZT2036S or F
		—	42	42.00 (1066.8)	20.00 (508.0)	5.75 (146.1)	YS2042	LT2042S or F	EZB2042R	EZT2042S or F
Main lugs or main breaker	PDG2xG, PDG2xM (V)	—	18	36.00 (914.4)	20.00 (508.0)	5.75 (146.1)	YS2036	LT2036S or F	EZB2036R	EZT2036S or F
		—	30	42.00 (1066.8)	20.00 (508.0)	5.75 (146.1)	YS2042	LT2042S or F	EZB2042R	EZT2042S or F
		—	42	48.00 (1219.2)	20.00 (508.0)	5.75 (146.1)	YS2048	LT2048S or F	EZB2048R	EZT2048S or F
Main lugs or main breaker with 125 A through-feed lugs or sub-feed breaker	PDG2xG, PDG2xM (V)	PDG2xF, PDG2xG	18	48.00 (1219.2)	20.00 (508.0)	5.75 (146.1)	YS2048	LT2048S or F	EZB2048R	EZT2048S or F
		PDG2xM, TFL (V)	30	60.00 (1524.0)	20.00 (508.0)	5.75 (146.1)	YS2060	LT2060S or F	EZB2060R	EZT2060S or F
		—	42	60.00 (1524.0)	20.00 (508.0)	5.75 (146.1)	YS2060	LT2060S or F	EZB2060R	EZT2060S or F
250 A										
Main lugs or main breaker	PDD2xG, PDD2xM, PDG2xG, PDG2xM (V)	—	18	36.00 (914.4)	20.00 (508.0)	5.75 (146.1)	YS2036	LT2036S or F	EZB2036R	EZT2036S or F
		—	30	42.00 (1066.8)	20.00 (508.0)	5.75 (146.1)	YS2042	LT2042S or F	EZB2042R	EZT2042S or F
		—	42	48.00 (1219.2)	20.00 (508.0)	5.75 (146.1)	YS2048	LT2048S or F	EZB2048R	EZT2048S or F
Main lugs or main breaker with 225 A through-feed lugs or sub-feed breaker	PDG2xG, PDG2xM, PDD2xG, PDD2xM (V)	PDG2xG, PDG2xM, PDD2xG, PDD2xM (V)	18	48.00 (1219.2)	20.00 (508.0)	5.75 (146.1)	YS2048	LT2048S or F	EZB2048R	EZT2048S or F
		—	30	60.00 (1524.0)	20.00 (508.0)	5.75 (146.1)	YS2060	LT2060S or F	EZB2060R	EZT2060S or F
		—	42	60.00 (1524.0)	20.00 (508.0)	5.75 (146.1)	YS2060	LT2060S or F	EZB2060R	EZT2060S or F
400 A										
Main breaker	PDD3xG, PDG3xG, PDG3xM, PDG3xP (V)	—	18	48.00 (1219.2)	20.00 (508.0)	5.75 (146.1)	YS2048	LT2048S or F	EZB2048R	EZT2048S or F
		—	30	60.00 (1524.0)	20.00 (508.0)	5.75 (146.1)	YS2060	LT2060S or F	EZB2060R	EZT2060S or F
		—	42	60.00 (1524.0)	20.00 (508.0)	5.75 (146.1)	YS2060	LT2060S or F	EZB2060R	EZT2060S or F
Main breaker with 225 A through-feed lugs or sub-feed breaker	PDD3xG, PDG3xG, PDG3xM, PDG3xP (V)	PDG2xF, PDG2xG, PDG2xM, PDD2xF, PDD2xG, PDD2xM (V)	18	60.00 (1524.0)	20.00 (508.0)	5.75 (146.1)	YS2060	LT2060S or F	EZB2060R	EZT2060S or F
		—	30	72.00 (1828.8)	20.00 (508.0)	5.75 (146.1)	YS2072	LT2072S or F	EZB2072R	EZT2072S or F
		—	42	72.00 (1828.8)	20.00 (508.0)	5.75 (146.1)	YS2072	LT2072S or F	EZB2072R	EZT2072S or F
Main lugs or main breaker with 400 A through-feed lugs or sub-feed breaker	PDD3xG, PDG3xG, PDG3xM, PDG3xP (V)	PDD3xG, PDG3xG, PDG3xM, PDG3xP (V)	18	72.00 (1828.8)	20.00 (508.0)	5.75 (146.1)	YS2072	LT2072S or F	EZB2072R	EZT2072S or F
		—	30	72.00 (1828.8)	20.00 (508.0)	5.75 (146.1)	YS2072	LT2072S or F	EZB2072R	EZT2072S or F
		—	42	90.00 (2286.0)	20.00 (508.0)	5.75 (146.1)	YS2090	LT2090S or F	EZB2090R	EZT2090S or F

PRL3E Branch Circuit Breakers

Ampere Rating	Interrupting Rating (kA Symmetrical)			Breaker Type
	240 Vac	480 Vac	250 Vdc	
15–125	25	18	10	EGB
15–125	85	35	35	EGS
15–125	100	65	42	EGH

Note

① Smaller panelboard box sizes are available if required. Contact Eaton for application information.

Type PRL3X



Contents

<i>Description</i>	<i>Page</i>
Product Description	V2-T3-7
Application Description	V2-T3-8
Standards and Certifications	V2-T3-10
Power Xpert Release Trip Unit for Molded Case Circuit Breakers	V2-T3-11
Technical Data and Specifications	V2-T3-12
Type PRL1X	V2-T3-18
Type PRL1XF	V2-T3-22
Type PRL1X-LX	V2-T3-25
Type PRL2X	V2-T3-29
Type PRL2XF	V2-T3-33
Type PRL2X-LX	V2-T3-36
Retrofit Panelboard	V2-T3-40
Type PRL3E	V2-T3-48
Type PRL3X	V2-T3-52
Product Selection	V2-T3-53
Box Sizing and Selection	V2-T3-55
Type PRL3XF	V2-T3-56
Type PRL3FQS	V2-T3-59
Type PRL4X	V2-T3-62
Type PRL4DX	V2-T3-72

Type PRL3X

Product Description

- 600 Vac maximum (250 Vdc)
- Three-phase four-wire, three-phase three-wire, single-phase three-wire, single-phase two-wire
- 800 A maximum main lugs
- 600 A maximum main breaker
- 225 A maximum branch breakers
- Bolt-on branch breakers
- Factory assembled
- Refer to **Page V2-T3-7** for additional information

Application Description

- Lighting panelboard or power distribution panelboard
- Fully rated or series rated
- Interrupting ratings up to 200 kA symmetrical
- Suitable for use as Service Entrance Equipment, when specified on the order
- See **Pages V2-T3-7** through **V2-T3-17** for additional information

Standards and Certifications

- UL 67, UL 50
- CSA C22.2 No. 29
- Federal Specification W-P-115c
- Refer to **Page V2-T3-10** for additional information



Product Selection

Type PRL3X



PRL3X

Ampere Rating	Interrupting Rating (kA Symmetrical)				Breaker Type
	240 Vac	480 Vac	600 Vac	250 Vdc	
Main Lug Only					
100	—	—	—	—	—
250	—	—	—	—	—
400	—	—	—	—	—
600	—	—	—	—	—
800 ①	—	—	—	—	—
Main Breaker					
100	35	25	14	10	PDG2xF
100	35	—	—	—	PDD2xF
100	65	—	—	—	PDD2xG
100	100	—	—	—	PDD2xM
100	65	35	18	10	PDG2xG
100	100	65	25	22	PDG2xM
100	200	100	35	22	PDG2xP
100	200	150	—	—	FCL
100	200	200	200	100 ②	FB-P ③
225	35	—	—	—	PDD2xF
225	65	—	—	—	PDD2xG
225	100	—	—	—	PDD2xM
225	200	—	—	—	PDD2xP
225	65	35	18	10	PDG2xG
225	100	65	25	22	PDG2xM
225	200	100	35	22	PDG2xP
400	65	—	—	10	PDD3xG
400	65	35	18	—	PDF3xG ④
400	65	35	18	10	PDG3xG ④
400	65	35	18	—	PDF3xM ④
400	100	65	35	22	PDG3xM ④
400	100	65	—	—	LHH
400	200	100	65	22	PDG3xP ④
400	200	200	200	100 ②	LA-P ③④
600	65	35	18	22	PDG3xG ④
600	100	65	35	22	PDG3xM ④
600	200	100	65	42	PDG3xP ④
600	65	35	25	22	CLD ⑤

Notes

- ① 800 A MLO requires 28-inch (711.2 mm) wide box.
- ② 100,000 based on NEMA test procedure.
- ③ Top feed only.
- ④ Requires 6.50-inch (165.1 mm) deep box. Not available in Type 3R, 12, 4 and 4X enclosures.
- ⑤ 100% rated circuit breaker. Requires copper bus. Not available in Type 12, 4 and 4X enclosures.
- ⑥ The 400 A frame must use trip units of ratings 100–400, while the 600 A frame must use trip units of ratings 500, 600 or designated by H, such as H250. The H as the leading character of the ampacity indicates a high instantaneous version of the breaker for coordination purposes. H ratings must use 600 A frame.

3.3

Panelboards and Lighting Control

Pow-R-Line Xpert Panelboards

3

PRL3X Branch Circuit Breakers

Ampere Rating	Interrupting Rating (kA Symmetrical)			250 Vdc	Breaker Type
	240 Vac	480 Vac	600 Vac		
15-60	10 (2)(3)	—	—	—	BAB
15-60	10	—	—	—	BAB-H
70	10 (2)(3)	—	—	—	BAB
70	10	—	—	—	BAB-H
80-100	10 (2)(3)	—	—	—	BAB
80-100	10	—	—	—	BAB-H
15-50 (1)	10 (2)(3)	—	—	—	BABEM
40	10	—	—	—	BABEVEM
15-50 (1)	10 (2)(3)	—	—	—	QBGF
15-50 (1)	10	—	—	—	QBGFEP
15-20	10 (2)(3)	—	—	—	QB-CAF (4)
15-20	10 (2)(3)	—	—	—	QB-GF
15-20	10 (2)(3)	—	—	—	QB-EP
15-20	10 (2)(3)	—	—	—	QB-AFGF (4)
15-20	10 (2)(3)	—	—	—	QB-CAF (4)
15-60	10 (2)(3)	—	—	—	BAB-D (5)
15-30	10 (2)(3)	—	—	—	BAB-C (6)
15-30	10 (2)	—	—	—	BABRP (7)
15-30	10 (2)	—	—	—	BABRSP (7)
15-60	22 (2)(3)	—	—	—	QBHW
15-60	22	—	—	—	QBHW-H
70	22 (2)(3)	—	—	—	QBHW
70	22	—	—	—	QBHW-H
80-100	22 (2)(3)	—	—	—	QBHW
80-100	22	—	—	—	QBHW-H
15-30	22	—	—	—	QBHGF
15-30	22	—	—	—	QBHGFEP
15-20	22 (2)(3)	—	—	—	QBHCAF (4)
15-20	22 (2)(3)	—	—	—	QBH-GF
15-20	22 (2)(3)	—	—	—	QBH-EP
15-20	22 (2)(3)	—	—	—	QBH-AFGF (4)
15-20	22 (2)(3)	—	—	—	QBH-CAF (4)
15-30	65	14 (8)(9)	—	—	GHQ
15-20	65	14 (8)(9)	—	14	GHB

PRL3X Branch Circuit Breakers, continued

Ampere Rating	Interrupting Rating (kA Symmetrical)			250 Vdc	Breaker Type
	240 Vac	480 Vac	600 Vac		
25-60	65	14 (8)(9)	—	14	GHB
70-100	65	14 (8)(9)	—	14	GHB
15-30	65	25 (8)(9)	—	—	HGHB
15-20	65	14	—	—	GHQRD (7)
15-20	65	14 (8)(9)	—	14	GHQRSP (7)
15-60	—	14 (8)(9)	—	—	GHBGFEP
15-20	—	14 (8)(9)	—	—	GHBHID (8)
15-60	35 (10)	25 (8)	—	10	PDG2xF
70-100	35 (10)	25 (8)	—	10	PDG2xF
15-60	65 (10)	35 (8)	18	10	PDG2xG
70-100	65 (10)	35 (8)	18	10	PDG2xG
110-225	65 (10)	35	18	10	PDG2xG (10)
15-60	100 (10)	65 (8)	25	22	PDG2xM
70-100	100 (10)	65 (8)	25	22	PDG2xM
110-225	100 (10)	65	25	22	PDG2xM (10)
15-60	200	100	35	22	PDG2xP
70-100	200	100	35	22	PDG2xP
110-225	200	100	35	22	PDG2xP (10)
100-225	35	—	—	—	PDD2xF (10)
100-225	65	—	—	—	PDD2xG (10)
100-225	100	—	—	—	PDD2xM (10)
100-225	200	—	—	—	PDD2xP (10)

Notes

- ① 50 A devices are available as two-pole only.
- ② Single-pole breaker rated 120 Vac.
- ③ Two-pole breaker rated 120/240 Vac.
- ④ Arc fault circuit breaker.
- ⑤ HID (High Intensity Discharge) rated breaker.
- ⑥ Switching neutral breaker. single-pole device requires two-pole space, two-pole device requires three-pole space.
- ⑦ Remote operated circuit breaker.
- ⑧ Single-pole breaker rated 277 Vac.
- ⑨ For use on 480Y/277 V systems only.
- ⑩ AIC rating for two- and three-pole breakers only.
- ⑪ Maximum of six breakers per panel, 175-225 A.

Box Sizing and Selection

Approximate Dimensions in Inches (mm)

Panel Layout Instructions

1. Select:
 - a. Required mains (lugs or breaker).
 - b. Neutral where required.
 - c. Branch circuits as required.
2. Layout panel as shown below, using appropriate "X" dimensions.
3. Using total X units (panel height) find box height in inches (mm) and box catalog number from table below. (When total X units come out to an uneven number, use next highest number; i.e., if total X comes out 25X, use 31X.)

Layout—PRL3X

		Poles		
		6–3X	BAB, QBHW, QBCAF,	
		12–5X	BABRP, BABRSP, BABEM,	
		18–8X	BABEVEM, QBHCAF,	
		24–10X	GHQ, GHQRD, GHQRSP,	
		30–13X	GHB, HGHB	
		36–15X	①	
		42–18X		
		1X	PDD2xF, PDD2xG, PDD2xM, PDD2xP	
		2X	PDG2xF, PDG2xG, PDG2xM, PDG2xP	
		3X	150 A max. per branch breaker (300 A max. per connector)	②
		2X 2-Pole 3X three-pole	PDD2xF, PDD2xG, PDD2xM, PDD2xP, PDG2xG, PDG2xM, PDG2xP ③	②
Neutral Section		5X	100–250 A	
		8X	400–800 A	
		11X	800 A with through-feed lug	
Main Lug Section ④		2X	100 A	
		5X	250 A	
		8X	400–600 A	
		14X	800 A	
Main Breaker Section	Horizontal Mounting	2X	PDG2xF, PDG2xG, PDG2xM, PDG2xP	
		3X	PDD2xF, PDD2xG, PDD2xM, PDD2xP ⑤	
		7X	PDG2xF, PDG2xG, PDG2xM, PDG2xP, PDD2xF, PDD2xG, PDD2xM, PDD2xP ⑥	
	Vertical Mounting	9X	FCL, FB-P ⑦	
		15X	PDD3xG, PDG3xG, PDG3xM, PDG3xP, LHH	
		17X	CLD	
		18X	PDG3xG, PDG3xM, PDG3xP	
		21X	LA-P ⑦⑧	

Notes

- ① GHB, HGHB, GHQ, GHQRD and GHQRSP breakers cannot be mixed on same connector as BAB, QBHW, BABRP and BABRSP.
- ② PD2 with PXR trip units may require additional 1X for wire spacing.
- ③ Maximum of six breakers per panel.
- ④ Sizing shown is for 100% rated neutral with mechanical lugs. For 200% rated neutral with mechanical lugs, add 3X. For specific lug arrangements, contact Eaton.
- ⑤ Horizontal mounted 15–150 A main breakers PDG2xF, PDG2xG, PDG2xM and PDG2xP, will be furnished as branch breaker construction. Branch breakers single-, two- or three-pole as required, may be located opposite these main breakers.
- ⑥ If optional terminal kit 3TA225FDK is required, use 10X.
- ⑦ FB-P and LA-P top mounting only.
- ⑧ LA-P main breaker requires 6-1/2-inch (165.1 mm) deep box.

Layout Example

1. Description of Panel
Type PRL3X three-phase, four-wire, 120/208 Vac flush mounting. Panel to have short-circuit rating of 22,000 symmetrical amperes. Main breaker 400 A, three-pole, bottom mounting. Branch circuits bolt-on as follows:
12–200 A single-pole QBHW
1–200 A three-pole PDD2xG
1–225 A three-pole PDD2xG
2. Layout Information from **Layout—PRL3X** table (left):
 - a. 400 A neutral = 8X
 - b. 12-poles of QBHW = 5X
 - c. Two three-pole PDD2xG breakers. . . . = 6X
 - d. Main breaker, 400 A,
three-pole PDD3xG = 15X
Total height = 34X
3. From **Box Tabulation—PRL3X** table (below):
 - a. 34X height (use 40X box)
 - b. Box height 72 inches (1828.8 mm)
 - c. Box catalog number **YS2072** or **EZB2072R**

Box Tabulation—PRL3X

"X" Units	Box Height	YS Box Catalog Number	LT Trim Catalog Number	EZ Box Catalog Number	EZ Trim Catalog Number
100–400 A					
14X	36.00 (914.4)	YS2036	LT2036S or F	EZB2036R	EZT2036S or F
23X	48.00 (1219.2)	YS2048	LT2048S or F	EZB2048R	EZT2048S or F
31X	60.00 (1524.0)	YS2060	LT2060S or F	EZB2060R	EZT2060S or F
40X	72.00 (1828.8)	YS2072	LT2072S or F	EZB2072R	EZT2072S or F
53X	90.00 (2286.0)	YS2090	LT2090S or F	EZB2090R	EZT2090S or F
600 A					
23X	48.00 (1219.2)	YS2048	LTV2048S or F	EZB2048R	EZTV2048S or F
31X	60.00 (1524.0)	YS2060	LTV2060S or F	EZB2060R	EZTV2060S or F
40X	72.00 (1828.8)	YS2072	LTV2072S or F	EZB2072R	EZTV2072S or F
53X	90.00 (2286.0)	YS2090	LTV2090S or F	EZB2090R	EZTV2090S or F
800 A					
23X	48.00 (1219.2)	YS2848	LTV2848S or F	EZB2848R	EZTV2848S or F
31X	60.00 (1524.0)	YS2860	LTV2860S or F	EZB2860R	EZTV2860S or F
40X	72.00 (1828.8)	YS2872	LTV2872S or F	EZB2872R	EZTV2872S or F
53X	90.00 (2286.0)	YS2890	LTV2890S or F	EZB2890R	EZTV2890S or F

Cabinets

Fronts are code-gauge steel, ANSI-61 light gray painted finish.

Boxes are code-gauge galvanized steel without knockouts. Standard depth is 5-3/4 inches (146.1 mm).

Standard widths are:
20-inch (508.0 mm)
100–600 A.
28-inch (711.2 mm)
800 A.

Standard Depth

5-3/4 inches (146.1 mm).

Top and Bottom Gutters

5-1/2 inches (139.7 mm) minimum.

Side Gutters

4 inches (101.6 mm) minimum.

Type PRL3XF



Type PRL3XF

Product Description

The Pow-R-Line 3XF (PRL3XF) is a fusible lighting panel designed for high fault current applications where circuit breakers may not meet the application. This panel is ideal when selective coordination mandates apply. Designed for use with Eaton's Bussmann® CUBEFuse®, the panel will selectively coordinate with the maximum available fault current.

Application Description

- Hospitals
- Surgery centers
- Emergency systems
- Fire stations
- Police stations
- Laboratories
- Communication systems
- Ventilation and smoke removal systems
- Critical industrial processes
- Data centers
- Other critical or sensitive loads

Panelboard Ratings

Voltage

- 600 Vac maximum
- 125 Vdc maximum (80 A maximum branch)

Short-Circuit Current Ratings

- 50 kAIC symmetrical standard
- 100 kAIC and 200 kAIC symmetrical available with select combinations

Mains

- Main lugs: 100–400 A
- Main fusible switch: 30–400 A
- Main non-fusible switch: 30–400 A

Service Entrance Equipment

- Labeled suitable for use as service entrance equipment (bonded neutral)

Contents

Description

Description	Page
Product Description	V2-T3-7
Application Description	V2-T3-8
Standards and Certifications	V2-T3-10
Power Xpert Release Trip Unit for Molded Case Circuit Breakers	V2-T3-11
Technical Data and Specifications	V2-T3-12
Type PRL1X	V2-T3-18
Type PRL1XF	V2-T3-22
Type PRL1X-LX	V2-T3-25
Type PRL2X	V2-T3-29
Type PRL2XF	V2-T3-33
Type PRL2X-LX	V2-T3-36
Retrofit Panelboard	V2-T3-40
Type PRL3E	V2-T3-48
Type PRL3X	V2-T3-52
Type PRL3XF	V2-T3-56
Product Selection	V2-T3-57
Type PRL3FQS	V2-T3-59
Type PRL4X	V2-T3-62
Type PRL4DX	V2-T3-72

Branch Overcurrent Devices

- Eaton Bussmann Type Compact Circuit Protector Base (CCP2B)
- 15–100 A
- Single-, two- and three-pole
- Branch fuses: Bussmann TCF or FCF CUBEFuse
- Maximum branch device ampacity by bus rating
 - 100 A: 60 A branch device
 - 200 A: 60 A branch device
 - 400 A: 100 A branch device (170 A total for twin devices)

Branch Circuit Spaces

- 18, 30 and 42 circuit chassis

Spare Fuse Compartment

- Provisions for six spare CUBEFuses, standard

Replacement Fuses

- Replace only with Bussmann fuses of the same type and size
- Contact your authorized Eaton Bussmann distributor for replacement fuses

Standards and Certifications

Listings

- UL 67 panelboard chassis
- UL 50 Listed box and trim
- UL 98 Listed fusible switches



Seismic Qualifications

Qualified for International Building Code (IBC) categories and site class A, B, C and D.

Product Selection

Type PRL3XF

PRL3XF Mains kAIC



Main Device	Switch Frames (Amperes)	Interrupting Rating (kA Symmetrical)	
		600 Vac	125 Vac
Main lugs only (MLO)	—	—	—
Fusible	30, 60, 100, 200, 400	50	50
Fusible (High SCCR)	30, 60, 100, 200, 400	200	100
Non-fusible	30, 60, 100, 200, 400	10	10
Non-fusible (High SCCR)	30, 60, 100, 200, 400	200 ①	100 ①

① When protected by upstream Bussmann class CF, J, or T fuses with equivalent ampere rating.

Technical Data and Specifications

Bussing

- 100–400 A: Silver-plated copper bus and branch connectors

Boxes

- Boxes are made from code-gauge galvanized steel
- Blank ends are supplied as standard, knockouts are available upon request

EZ Trim

- Trims are made from code-gauge steel and painted ANSI 61 gray
- All panelboards have door-in-door as standard with multi-point catch and lock, and concealed mounting hardware

Standard Terminals

Main Lugs

Ampere Rating	Standard Mechanical Lug Wire Range
100 A	(1) #1–300 kcmil
200 A	(1) #1–300 kcmil
400 A	(1) #4–600 kcmil

Main Fusible Switch (Class J Fuses Only)

Ampere Rating	Standard Mechanical Lug Wire Range
100 A	(1) #1–300 kcmil
200 A	(1) #1–300 kcmil
400 A	(1) #4–600 kcmil

Main Non-Fusible Switch

Ampere Rating	Standard Mechanical Lug Wire Range
100 A	(1) #1–300 kcmil
200 A	(1) #1–300 kcmil
400 A	(1) #4–600 kcmil

Modifications

Sub-Feed Lugs (Main Lugs)

Ampere Rating	Panel Height Addition
100 A	0 Inches (0 mm)
200 A	0 Inches (0 mm)

Through-Feed Lugs

Ampere Rating	Information
100 A	See Table 22.10-8
200 A	See Table 22.10-8
400 A	See Table 22.10-8

Neutral

Mounted on chassis. Same material as main bus.

Ground Bar

Standard bolted in box. Aluminum is standard.

Enclosures

Types 1 and 3R (up to 200 A).

Surge Protective Device (SPD)

Integrated onto panelboard chassis. For complete product description and available ratings, refer to Surge Protection (SPD) & Power Conditioning Products Design Guides.

Branch Circuit Disconnects Technical Data

Branch Circuit Disconnects Compact Circuit Protector Base (CCP2B)

CCP2B ^① Part Number	Number of Poles	Fuse Ampere Range	Maximum CCP2B Ampacity	Non-Indicating Fuses (Standard) ^①	Indicating Fuses (Optional) ^{①②}
CCP2B-1-15CF	1	1–15	15	TCF1RN, TCF3RN, TCF6RN, TCF10RN, TCF15RN	TCF6, TCF10, TCF15
CCP2B-2-15CF	2	1–15	15	TCF1RN, TCF3RN, TCF6RN, TCF10RN, TCF15RN	TCF6, TCF10, TCF15
CCP2B-3-15CF	3	1–15	15	TCF1RN, TCF3RN, TCF6RN, TCF10RN, TCF15RN	TCF6, TCF10, TCF15
CCP2B-1-20CF	1	17.5–20	20	TCF17-1/2RN, TCF20RN	TCF17-1/2, TCF20
CCP2B-2-20CF	2	17.5–20	20	TCF17-1/2RN, TCF20RN	TCF17-1/2, TCF20
CCP2B-3-20CF	3	17.5–20	20	TCF17-1/2RN, TCF20RN	TCF17-1/2, TCF20
CCP2B-1-30CF	1	25–30	30	TCF25RN, TCF30RN	TCF25, TCF30
CCP2B-2-30CF	2	25–30	30	TCF25RN, TCF30RN	TCF25, TCF30
CCP2B-3-30CF	3	25–30	30	TCF25RN, TCF30RN	TCF25, TCF30
CCP2B-1-40CF	1	35–40	40	TCF35RN, TCF40RN	TCF35, TCF40
CCP2B-2-40CF	2	35–40	40	TCF35RN, TCF40RN	TCF35, TCF40
CCP2B-3-40CF	3	35–40	40	TCF35RN, TCF40RN	TCF35, TCF40
CCP2B-1-50CF	1	45–50	50	TCF45RN, TCF50RN	TCF45, TCF50
CCP2B-2-50CF	2	45–50	50	TCF45RN, TCF50RN	TCF45, TCF50
CCP2B-3-50CF	3	45–50	50	TCF45RN, TCF50RN	TCF45, TCF50
CCP2B-1-60CF	1	60	60	TCF60RN	TCF60
CCP2B-2-60CF	2	60	60	TCF60RN	TCF60
CCP2B-3-60CF	3	60	60	TCF60RN	TCF60
CCP2B-1-70CF	1	70	70	TCF70RN	TCF70
CCP2B-2-70CF	2	70	70	TCF70RN	TCF70
CCP2B-3-70CF	3	70	70	TCF70RN	TCF70
CCP2B-1-90CF	1	80–90	90	TCF80RN, TCF90RN	TCF80, TCF90
CCP2B-2-90CF	2	80–90	90	TCF80RN, TCF90RN	TCF80, TCF90
CCP2B-3-90CF	3	80–90	90	TCF80RN, TCF90RN	TCF80, TCF90
CCP2B-1-100CF	1	100	100	TCF100RN	TCF100
CCP2B-2-100CF	2	100	100	TCF100RN	TCF100
CCP2B-3-100CF	3	100	100	TCF100RN	TCF100

Notes

① CCP2B disconnect can accept CUBEFuses with ampere ratings less than or equal to the ampere rating of the CCP2B disconnect.

② Correct fit with CCP2B disconnect requires indicating CUBEFuses with date code R38 or later.

Note: Spare or replacement CCP2B available only from authorized Eaton Bussmann distributors.

CCP2B Horsepower Ratings

CCP2B Disconnect	Ampere Rating	Horsepower Rating at Vac			
		120	240	480	600
CCP2B-(Poles)-15CF	15	0.5	3.0	5.0	7.5
CCP2B-(Poles)-20CF	20	0.75	3.0	7.5	10.0
CCP2B-(Poles)-30CF	30	1.5	5.0	15.0	10.0
CCP2B-(Poles)-40CF	40	2.0	7.5	20.0	10.0
CCP2B-(Poles)-50CF	50	3.0	7.5	20.0	10.0
CCP2B-(Poles)-60CF	60	3.0	7.5	20.0	10.0
CCP2B-(Poles)-70CF	70	3.0	15.0	30.0	40.0
CCP2B-(Poles)-90CF	80	5.0	20.0	40.0	50.0
CCP2B-(Poles)-100CF	100	5.0	20.0	50.0	50.0

Type PRL3FQS



Type PRL3FQS

Product Description

The Pow-R-Line 3FQS is a fusible lighting panel designed for high fault current applications where circuit breakers may not meet the application. This panel is ideal when the selective coordination mandates apply. Designed for use with Eaton's Bussmann CUBEFuse, the panel will selectively coordinate with the maximum available fault current. The PRL3FQS is ideal for control circuits below 15 A.

Panelboard Ratings

Voltage

- 600 Vac maximum
- 125 Vdc maximum (80 A maximum branch)

Mains

- Main lugs: 30–400 A
- Main fusible switch: 30–400 A
- Main non-fusible switch: 30–400 A

Voltage Systems

- 120 V, single-phase, two-wire
- 240 V, single-phase, two-wire
- 240 V, single-phase, two-wire—no neutral
- 277 V, single-phase, two-wire
- 120/240 V, single-phase, three-wire
- 208/120 V, single-phase, three-wire
- 480/240 V, single-phase, three-wire
- 277/480 V, single-phase, three-wire
- 480 V, single-phase, two-wire—no neutral
- 240 V, three-phase, three-wire
- 480 V, three-phase, three-wire
- 600 V, three-phase, three-wire
- 208/120 V, three-phase, four-wire
- 480/277 V, three-phase, four-wire
- 600/347 V, three-phase, four-wire
- 240/120 V, three-phase, four-wire
- 480/240 V, three-phase, four-wire
- 120/240 Vac, single-phase, three-wire
- 208Y/120 Vac, three-phase, four-wire
- 240 delta/120 Vac, three-phase, four-wire
- 480Y/277 Vac, three-phase, four-wire
- 600Y/347 Vac, three-phase, four-wire
- 240 delta Vac, three-phase, three-wire
- 480 delta Vac, three-phase, three-wire
- 600 delta Vac, three-phase, three-wire
- 25 Vdc

Contents

<i>Description</i>	<i>Page</i>
Product Description	V2-T3-7
Application Description	V2-T3-8
Standards and Certifications	V2-T3-10
Power Xpert Release Trip Unit for Molded Case Circuit Breakers	V2-T3-11
Technical Data and Specifications	V2-T3-12
Type PRL1X	V2-T3-18
Type PRL1XF	V2-T3-22
Type PRL1X-LX	V2-T3-25
Type PRL2X	V2-T3-29
Type PRL2XF	V2-T3-33
Type PRL2X-LX	V2-T3-36
Retrofit Panelboard	V2-T3-40
Type PRL3E	V2-T3-48
Type PRL3X	V2-T3-52
Type PRL3XF	V2-T3-56
Type PRL3FQS	V2-T3-60
Application Description	V2-T3-60
Standards and Certifications	V2-T3-60
Options	V2-T3-60
Product Selection	V2-T3-60
Technical Data and Specifications	V2-T3-61
Box Sizing and Selection	V2-T3-61
Type PRL4X	V2-T3-62

Short-Circuit Current Ratings

- 50 kAIC symmetrical standard
- Up to 200 kAIC symmetrical when appropriate upstream overcurrent device is applied

Main Bus and Branch Connectors

- Tin plated, copper bus and branch connectors

Enclosures

- NEMA Type 1
- NEMA Type 3R

Branch Circuit Spaces

- 18, 30 and 42 circuit chassis

Incoming Line

- Top or bottom

Spare Fuse Compartment

- Provisions for six spare CUBEFuses, standard

Application Description

- Hospitals
- Surgery centers
- Emergency systems
- Fire stations
- Police stations
- Laboratories
- Communication systems
- Ventilation and smoke removal systems
- Critical industrial processes
- Data centers
- Other critical or sensitive loads

Standards and Certifications

- UL 67 panelboard chassis
- UL 50 listed box and trim
- UL 98 listed fusible switches



Seismic Qualifications

- Qualified for International Building Code (IBC) categories and site class A, B, C and D



Options

Loadside Chassis

- Through-feed lugs
- Sub-feed lugs
- Sub-feed fusible switch
- Surge protective device

Service Equipment

- Labeled suitable for use as service equipment (bonded neutral)

Neutrals

- Isolated neutral
- Bonded neutral
- 200% rated neutrals

Ground Bars

- Bonded neutral
- Isolated neutral

Special Trims

- Door-in-door
- No trim

NEMA Type 1 Box Options

- No knockouts (standard)
- Knockouts, both top and bottom (optional)
- Knockouts, top or bottom (optional)

Replacement Fuses

- Replace only with Bussmann fuses of the same type and size
- Contact your authorized Eaton Bussmann distributor for replacement fuses
- Nameplates
- Permanent circuit numbering

Product Selection

Branch Circuit Disconnects Compact Circuit Protector Base (CCP2B)

CCP2B ^① Part Number	Number of Poles	Fuse Ampere Range	Maximum CCP2B Ampacity	Non-Indicating Fuses (Standard)	Indicating Fuses (Optional) ^②
CCP2B-1-15CF	1	1–15	15	TCF1RN, TCF3RN, TCF6RN, TCF10RN, TCF15RN	TCF6, TCF10, TCF15
CCP2B-2-15CF	2	1–15	15		
CCP2B-3-15CF	3	1–15	15		
CCP2B-1-20CF	1	17.5–20	20	TCF17-1/2RN, TCF20RN	TCF17-1/2, TCF20
CCP2B-2-20CF	2	17.5–20	20		
CCP2B-3-20CF	3	17.5–20	20		
CCP2B-1-30CF	1	25–30	30	TCF25RN, TCF30RN	TCF25, TCF30
CCP2B-2-30CF	2	25–30	30		
CCP2B-3-30CF	3	25–30	30		
CCP2B-1-40CF	1	35–40	40	TCF35RN, TCF40RN	TCF35, TCF40
CCP2B-2-40CF	2	35–40	40		
CCP2B-3-40CF	3	35–40	40		
CCP2B-1-50CF	1	45–50	50	TCF45RN, TCF50RN	TCF45, TCF50
CCP2B-2-50CF	2	45–50	50		
CCP2B-3-50CF	3	45–50	50		
CCP2B-1-60CF	1	60	60	TCF60RN	TCF60
CCP2B-2-60CF	2	60	60		
CCP2B-3-60CF	3	60	60		
CCP2B-1-70CF	1	70	70	TCF70RN	TCF70
CCP2B-2-70CF	2	70	70		
CCP2B-3-70CF	3	70	70		
CCP2B-1-90CF	1	80–90	90	TCF80RN, TCF90RN	TCF80, TCF90
CCP2B-2-90CF	2	80–90	90		
CCP2B-3-90CF	3	80–90	90		
CCP2B-1-100CF	1	100	100	TCF100RN	TCF100
CCP2B-2-100CF	2	100	100		
CCP2B-3-100CF	3	100	100		

① CCP2B disconnect can accept CUBEFuses with ampere ratings less than or equal to the ampere rating of the CCPB disconnect.

② Correct fit with CCP2B disconnect requires indicating CUBEFuses with date code R38 or later.

Note: Spare or replacement CCP2B available only from authorized Eaton Bussmann distributors.

Technical Data and Specifications

Main Lugs Only

Ampere Rating	Standard Mechanical Lug Wire Range
100	(1) #1–300 kcmil
200	(1) #1–300 kcmil
400	(1) #4–600 kcmil

Main Non-Fusible Switch

Ampere Rating	Standard Mechanical Lug Wire Range
100	(1) #1–300 kcmil
200	(1) #1–300 kcmil
400	(1) #4–600 kcmil

Main Fusible Switch (Class J Fuses Only)

Ampere Rating	Standard Mechanical Lug Wire Range
100	(1) #1–300 kcmil
200	(1) #1–300 kcmil
400	(1) #4–600 kcmil



Branch Disconnects

CCP2B Horsepower Ratings

CCP2B Disconnect	Ampere Rating	Horsepower Rating at Vac			
		120	240	480	600
CCP2B–(Poles)-15CF	15	0.5	3	5	7.5
CCP2B–(Poles)-20CF	20	0.75	3	7.5	10
CCP2B–(Poles)-30CF	30	1.5	5	15	10
CCP2B–(Poles)-40CF	40	2	7.5	20	10
CCP2B–(Poles)-50CF	50	3	7.5	20	10
CCP2B–(Poles)-60CF	60	3	7.5	20	10
CCP2B–(Poles)-70CF	70	3	15	30	40
CCP2B–(Poles)-90CF	80	5	20	40	50
CCP2B–(Poles)-100CF	100	5	20	50	50

Box Sizing and Selection

Approximate Dimensions in Inches (mm)

Enclosures

NEMA Type 1 Indoor

- Flush mount or surface mount
- Galvanized steel with removable end walls—blank or with knockouts (specify on order)
- Chassis mounts directly onto enclosure studs in the enclosure
- Trim finished with gray powder coat paint over phosphatized steel (ANSI 61) with door
- Circuit directory card is located on the inside of the door
- Concealed trim screws

NEMA Type 3R Outdoor (Optional)

- Surface mount only
- Finished with gray powder coat paint over phosphatized steel (ANSI 61)
- Bottom feed only, no knockouts
- Chassis mounts directly onto studs in the enclosure
- Gasketed door has vault handle with lock
- Circuit directory card is located on the inside of the door
- Contact Eaton for other enclosure types

NEMA Type 1 Box Sizes

Width	Depth	Height
20.00 (508.0)	5.75 (146.1)	33.00 (838.2)
20.00 (508.0)	5.75 (146.1)	50.00 (1270.0)
20.00 (508.0)	5.75 (146.1)	59.00 (1498.6)
20.00 (508.0)	5.75 (146.1)	69.00 (1752.6)

NEMA Type 3R Outdoor Box Sizes

Width	Depth	Height
20.00 (508.0)	7.75 (196.9)	34.50 (876.3)
20.00 (508.0)	7.75 (196.9)	51.50 (1308.1)
20.00 (508.0)	7.75 (196.9)	60.50 (1536.7)
20.00 (508.0)	7.75 (196.9)	70.50 (1790.7)

Type PRL4X



Type PRL4X Circuit Breaker and Type PRL4F Fusible Panelboards

Type PRL4X

Product Description

- 600 Vac maximum (600 Vdc)
- Three-phase, four-wire, three-phase three-wire, single-phase three-wire, single-phase two-wire
- PRL4X circuit breaker panelboard
- PRL4F fusible switch panelboard
- 1200 A maximum mains
- 1200 A maximum branch devices
- Bolt-on branch devices
- Factory assembled
- Refer to **Page V2-T3-7** for additional information

Application Description

- Power distribution panelboard
- Fully rated or series rated
- Interrupting ratings up to 200 kA symmetrical
- Suitable for use as Service Entrance Equipment, when specified on the order
- See **Pages V2-T3-7** through **V2-T3-17** for additional information

Contents

Description

	<i>Page</i>
Product Description	V2-T3-7
Application Description	V2-T3-8
Standards and Certifications	V2-T3-10
Power Xpert Release Trip Unit for Molded Case Circuit Breakers	V2-T3-11
Technical Data and Specifications	V2-T3-12
Type PRL1X	V2-T3-18
Type PRL1XF	V2-T3-22
Type PRL1X-LX	V2-T3-25
Type PRL2X	V2-T3-29
Type PRL2XF	V2-T3-33
Type PRL2X-LX	V2-T3-36
Retrofit Panelboard	V2-T3-40
Type PRL3E	V2-T3-48
Type PRL3X	V2-T3-52
Type PRL3XF	V2-T3-56
Type PRL3FQS	V2-T3-59
Type PRL4X	
Product Selection	V2-T3-63
Box Sizing and Selection—PRL4X	V2-T3-66
Box Sizing and Selection—PRL4F	V2-T3-69
Type PRL4DX	V2-T3-72

Standards and Certifications

- UL 67, UL 50
- CSA C22.2 No. 29
- Federal Specification
- W-P-115c
- Refer to **Page V2-T3-10** for additional information



Product Selection

Type PRL4X



PRL4X Main Lugs and Main Breakers

Ampere Rating	Interrupting Rating (kA Symmetrical)				250 Vdc	600 Vdc	Breaker Type
	240 Vac	480 Vac	600 Vac	600 Vac			
Main Lug Only							
250	—	—	—	—	—	—	—
400	—	—	—	—	—	—	—
600	—	—	—	—	—	—	—
800	—	—	—	—	—	—	—
1200	—	—	—	—	—	—	—
Main Breaker ^①							
250	—	—	—	42	35	HJDDC ^②	—
400	65	—	—	10	—	PDD3xG	—
400	65	35	25	10	—	PDG3xG ^④	—
400	65	35	25	—	—	PDF3xG ^{③④}	—
400	100	65	35	22	—	PDG3xM ^④	—
400	—	—	—	42	35	HKDDC ^②	—
400	100	65	35	42	—	LHH	—
400	100	65	35	—	—	PDF3xM ^{③④}	—
400	200	100	65	22	—	PDG3xP ^④	—
400	200	200	200	—	—	LA-P	—
600	65	35	18	22	—	PDG3xG ^{①④}	—
600	100	65	35	22	—	PDG3xM ^{①④}	—
600	200	100	50	42	—	PDG3xP ^④	—
600	65	35	25	—	—	CLD ^③	—
800	65	50	25	22	—	PDG4xG	—
800	100	65	35	25	—	PDG4xM	—
800	—	—	—	42	35	HMDLDC ^②	—
800	65	50	25	—	—	PDF4xG ^③	—
800	100	65	35	—	—	PDF4xM ^③	—
800	200	200	200	—	—	NB-P	—
800	100	65	35	—	—	PDG5xM	—
800	200	100	65	—	—	PDG5xP	—
800	200	100	65	—	—	PDG5xP	—
800	100	65	35	—	—	PDG5xM	—
800	85	50	25	—	—	NGS	—
800	65	50	25	—	—	CND ^{③⑤}	—
800	200	100	65	—	—	CNGC ^{③⑤}	—
800	100	65	35	—	—	CNGH ^{③⑤}	—
800	85	50	25	—	—	CNGS ^{③⑤}	—
1200	100	65	35	—	—	PDG5xM	—
1200	200	100	65	—	—	PDG5xP	—
1200	85	50	25	—	—	NGS	—
1200	65	50	25	—	—	CND ^{③⑤}	—
1200	200	100	65	—	—	CNGC ^{③⑤}	—
1200	100	65	35	—	—	CNGH ^{③⑤}	—
1200	85	50	25	—	—	CNGS ^{③⑤}	—
1200	—	—	—	42	50	NBDC ^②	—

PRL4X Main Fusible Switches

Ampere Rating	Interrupting Rating (kA Symmetrical)		Device Type
	240 Vac	480 Vac	
Main Fusible Switch 240 Vac, 250 Vdc ^{⑥⑦⑧}			
200	See Page V2-T3-65		FDPB
400	—		FDPW
600 ^⑨	—		FDPW
800 ^⑨	—		FDPW
1200 ^⑨	—		FDPW
Main Fusible Switch 600 Vac ^{⑥⑦}			
200	See Page V2-T3-65		FDPB
400	—		FDPW
600 ^⑨	—		FDPW
800 ^⑨	—		FDPW
1200 ^⑨	—		FDPW

Notes

- ① For ground fault protection on main devices, see **Modification 14—Applies to 310 and 310+ Trip Units on Page V2-T3-93 or Modification 15 on Page V2-T3-93.**
- ② For use on DC systems only.
- ③ 100% rated breaker. Requires copper bus. Not available in Type 12, 4 and 4X enclosures.
- ④ Breaker only available in three-pole frame.
- ⑤ Requires 44-inch (1117.6 mm) wide box.
- ⑥ For ground fault protection on main devices, see **Modification 15 on Page V2-T3-93.**
- ⑦ Fuses not included. **Specify required fuse clips on all switches.**
- ⑧ Class J Fuse provisions are applicable only to 600 V units. When required, use dimensions of 600 V units for all voltages 600 and below.
- ⑨ No DC rating on 600, 800 and 1200 A switches.
- ⑩ The 400 A frame must use trip units of ratings 100–400, while the 600 A frame must use trip units of ratings 500, 600 or designated by H, such as H250. The H as the leading character of the ampacity indicates a high instantaneous version of the breaker for coordination purposes. H ratings must use 600 A frame.

Pow-R-Line Xpert Panelboards

PRL4X Branch Devices

Ampere Rating	Interrupting Rating (kA Symmetrical)					Breaker Type
	240 Vac	480 Vac	600 Vac	250 Vdc	600 Vdc	
15-60	10 ⁽²⁾⁽³⁾	—	—	—	—	BAB
15-60	10	—	—	—	—	BAB-H
70-100	10 ⁽²⁾⁽³⁾	—	—	—	—	BAB
70-100	10	—	—	—	—	BAB-H
15-50 ⁽¹⁾	10 ⁽²⁾⁽³⁾	—	—	—	—	QBGF
15-20	10 ⁽²⁾⁽³⁾	—	—	—	—	QBCAF ⁽⁴⁾
15-60	22 ⁽²⁾⁽³⁾	—	—	—	—	QBHW
15-60	22	—	—	—	—	QBHW-H
70-100	22 ⁽²⁾⁽³⁾	—	—	—	—	QBHW
70-100	22	—	—	—	—	QBHW-H
15-30	22 ⁽²⁾⁽³⁾	—	—	—	—	QBHGF
15-20	22 ⁽²⁾⁽³⁾	—	—	—	—	QBHCAF ⁽⁴⁾
15-30	65 ⁽²⁾	14 ⁽⁵⁾	—	—	—	GHQ ⁽⁷⁾
15-60	65 ⁽²⁾	14 ⁽⁵⁾	—	14	—	GHB ⁽⁷⁾
70-100	65 ⁽²⁾	14 ⁽⁵⁾	—	14	—	GHB ⁽⁷⁾
15-30	65 ⁽²⁾	25 ⁽⁵⁾	—	—	—	HGHB ⁽⁷⁾
15-60	35 ⁽⁶⁾	25 ⁽⁵⁾	—	10	—	PDG2xF
70-100	35 ⁽⁶⁾	25 ⁽⁵⁾	—	10	—	PDG2xF
15-60	65 ⁽⁶⁾	35 ⁽⁵⁾	18	10	—	PDG2xG
70-100	65 ⁽⁶⁾	35 ⁽⁵⁾	18	10	—	PDG2xG
110-225	65 ⁽⁶⁾	35	18	10	—	PDG2xG
15-60	100 ⁽⁶⁾	65 ⁽⁵⁾	25	22	—	PDG2xM
70-100	100 ⁽⁶⁾	65 ⁽⁵⁾	25	22	—	PDG2xM
110-225	100 ⁽⁶⁾	65	25	22	—	PDG2xM
15-60	200	100	35	22	—	PDG2xP
70-100	200	100	35	22	—	PDG2xP
110-225	200	100	35	22	—	PDG2xP
15-100	200	150	—	—	—	FCL
15-150	—	—	—	42	35	HFDDC ⁽⁶⁾
100-225	35	—	—	—	—	PDD2xF
100-225	65	—	—	—	—	PDD2xG
100-225	100	—	—	—	—	PDD2xM
100-225	200	—	—	—	—	PDD2xP
70-250	—	—	—	42	35	HJDDC ⁽⁶⁾
250-400	65	—	—	10	—	PDD3xG

PRL4X Branch Devices, continued

Ampere Rating	Interrupting Rating (kA Symmetrical)					Breaker Type
	240 Vac	480 Vac	600 Vac	250 Vdc	600 Vdc	
100-400	65	35	25	10	—	PDG3xG ⁽⁸⁾
100-400	65	35	25	—	—	PDF3xG ⁽⁸⁾⁽⁹⁾⁽¹⁰⁾
100-400	100	65	35	22	—	PDG3xM ⁽⁸⁾
100-400	—	—	—	42	35	HKDDC ⁽⁶⁾
100-400	100	65	35	—	—	PDF3xM ⁽⁸⁾⁽⁹⁾⁽¹⁰⁾
125-400	100	65	35	42	—	LHH
100-400	200	100	65	22	—	PDG3xP ⁽⁸⁾
250-600	65	35	18	22	—	PDG3xG ⁽⁸⁾
300-600	65	35	25	—	—	CLD ⁽⁶⁾
250-600	100	65	35	22	—	PDG3xM ⁽⁸⁾
300-600	—	—	—	42	35	HLDC ⁽⁶⁾⁽⁹⁾
250-600	200	100	35	42	—	PDG3xP ⁽⁸⁾
400-800	65	50	18	22	—	PDG4xG
400-800	100	65	35	25	—	PDG4xM
300-800	—	—	—	42	35	HMDLDC ⁽⁶⁾⁽⁹⁾
400-800	65	50	25	—	—	PDF4xG ⁽⁸⁾
400-800	100	65	35	—	—	PDF4xM ⁽⁸⁾
320-800	85	50	25	—	—	PDG5xK
320-800	85	50	25	—	—	CNGS ⁽⁸⁾
320-800	100	65	35	—	—	PDG5xM
320-800	100	65	35	—	—	CNGH ⁽⁸⁾
320-800	200	100	65	—	—	PDG5xP
320-800	200	100	65	—	—	CNGC ⁽⁸⁾
500-1200	85	50	25	—	—	PDG5xK
500-1200	85	50	25	—	—	CNGS ⁽⁸⁾
500-1200	100	65	35	—	—	PDG5xM
500-1200	100	65	35	—	—	CNGH ⁽⁸⁾
500-1200	200	100	65	—	—	PDG5xP
500-1200	200	100	65	—	—	CNGC ⁽⁸⁾

Notes

- ⁽¹⁾ 50 A devices are available as two-pole only.
- ⁽²⁾ Single-pole breakers rated 120 Vac.
- ⁽³⁾ Two-pole breakers rated 120/240 Vac.
- ⁽⁴⁾ Arc fault circuit breaker.
- ⁽⁵⁾ Single-pole breakers rated 277 Vac.
- ⁽⁶⁾ For use on DC systems only.
- ⁽⁷⁾ At 480 V, must be used on 480Y/277 V grounded wye systems only.
- ⁽⁸⁾ AIC rating for two- and three-pole breakers only.
- ⁽⁹⁾ 100% rated breaker. Requires copper bus. Not available in Type 12, 4 and 4X enclosures.
- ⁽¹⁰⁾ Breaker only available in three-pole frame.
- ⁽¹¹⁾ Available in single branch mounting only.
- ⁽¹²⁾ The 400 A frame must use trip units of ratings 100-400, while the 600 A frame must use trip units of ratings 500, 600 or designated by H, such as H250. The H as the leading character of the ampacity indicates a high instantaneous version of the breaker for coordination purposes. H ratings must use 600 A frame.

PRL4X Branch Devices, continued

Ampere Rating	Interrupting Rating (kA Symmetrical)				Breaker Type
	240 Vac	480 Vac	600 Vac	250 Vdc	
Integrally Fused, Current Limiting Circuit Breaker					
15–100	200	200	200	①	FB-P
125–225	200	200	200	①	LA-P
250–400	200	200	200	①	LA-P
400–600	200	200	200	①	NB-P
700–800	200	200	200	①	NB-P
Fusible Switches 240 Vac, 250 Vdc ②					
30/30 ③	See table at the right				FDPW-Twin
60/60 ③					FDPW-Twin
100/100 ③					FDPW-Twin
200/200					FDPB-Twin
100					FDPW-Single
200					FDPB-Single
400	See table at the right				FDPW-Single
600 ④					FDPW-Single
800 ④					FDPW-Single
1200 ④					FDPW-Single
Fusible Switches 600 Vac ②					
30/30 ③	See table at the right				FDPW-Twin
60/60 ③					FDPW-Twin
100/100 ③					FDPW-Twin
200/200 ⑤					FDPB-Twin
100					FDPW-Single
200					FDPB-Single
400	See table at the right				FDPW-Single
600 ④					FDPW-Single
800 ④					FDPW-Single
1200 ④					FDPW-Single

FDPW and FDPB Switch Ratings, 240 or 600 Vac

Ampere Rating	Fuse Class Used	Short-Circuit Ratings (kA Symmetrical)
30–100	R, J ⑥	200
200 Single	R, J ⑥	200
200 Twin	R ⑥, J ⑥, T	200
400, 600 ⑦	R ⑦, J ⑥, T	200
800, 1200 ⑦	L	200

Notes

- ① 100 kAIC based on NEMA test procedure.
- ② Fuses not included. **Specify required fuse clips on all switches. (T fuse clips not available for 200/200 twin switches.)**
- ③ When branches of a twin unit are of different ampere ratings, as a 30–60 twin unit, price and layout as a 60–60 twin unit; when a 60–100 twin unit, price and layout as a 100–100 twin unit.
- ④ No DC rating on 600, 800 and 1200 A switches.
- ⑤ Class J fuse provisions are applicable to 600 V units. When required, use price and dimensions of 600 V units for all voltages 600 V and below.
- ⑥ Twin 200 A switches are not available with Class R fuse clips at 600 V.
- ⑦ When shunt trip is required, 400–600 A switches used with Class R fuses are rated 100 kAIC.

3.3

Panelboards and Lighting Control

Pow-R-Line Xpert Panelboards

Box Sizing and Selection—PRL4X

Approximate Dimensions in Inches (mm)

Main Lug Only (MLO), Main Breaker, Neutral, Through-Feed Lug (TFL) and Sub-Feed Lug (SFL) "X" Space Requirements. (For other configurations not shown, refer to Eaton.)

* = Space available for branch devices. For device sizing, see **Page V2-T3-68**.

● = Blank means no bus under cover, to meet NEC cable bending space.

PRL4X Layout

Standard Main Lug, Through-Feed and Sub-Feed Lugs (500 kcmil Maximum)

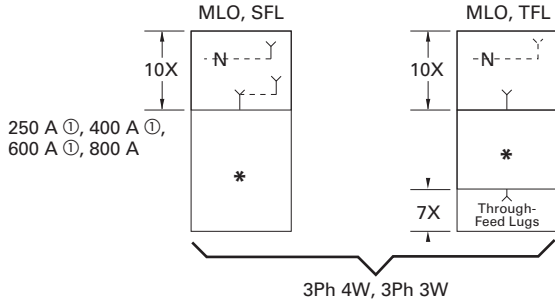

Main Breaker with Neutral (when required) (500 kcmil Maximum)

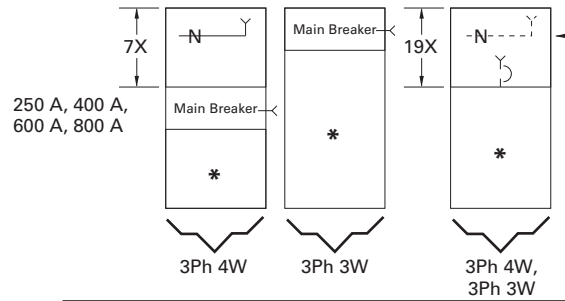

800 A Vertically Mtd. PDG4xG Main Breaker only in 24-inch (609.6 mm) wide box. Available with 38X and 50X Panel Height only.

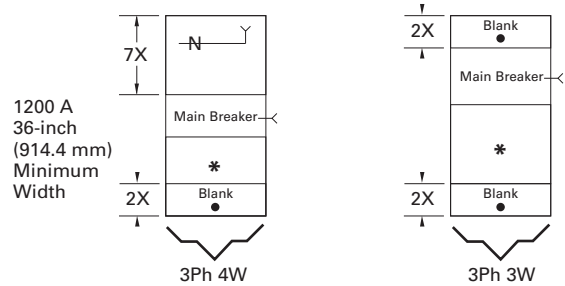
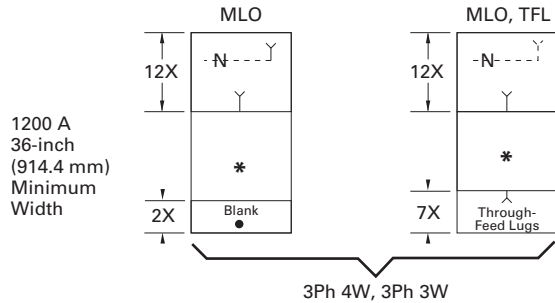

Optional Main Lugs, Through-Feed and Sub-Feed Lugs (750 kcmil Maximum)

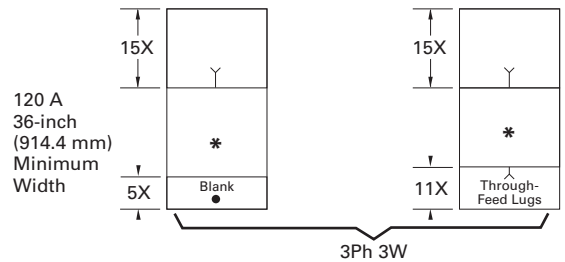
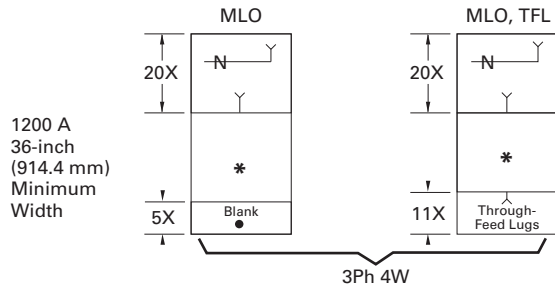
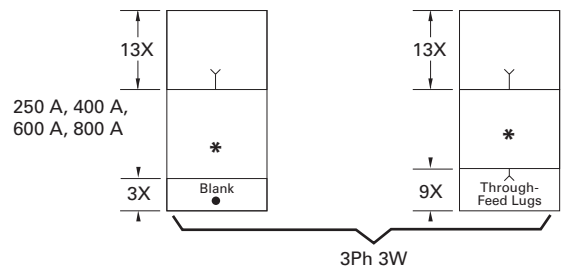
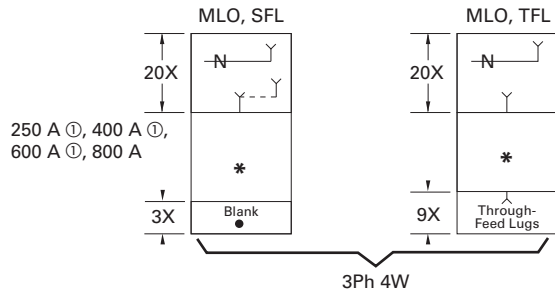

Note

① Sub-feed lugs are available 250–600 A. For 600 A, use 1200 A "A" space.

Approximate Dimensions in Inches (mm)

Panel Layout and Dimensions

To determine the dimensions of a given panelboard enclosure, make a layout sketch by fitting together the main, branch and lug modules according to the appropriate tables in the layout guide. Assign “X” units to each module as shown and obtain a total “X” number.

The height of the enclosure is related to the total “X” units in the layout as shown in table on right. Three standard box heights are available to accommodate any and all layout arrangements. “X” unit totals that do not exactly match those in table on right must be rounded off to the next highest standard (26X, 38X, 50X).

If a calculated “X” total for a panel exceeds 50X, the panel must be split into two or more separate sections with “X” space for through-feed lugs figured in for all but one section. If a neutral is required, a separate neutral bar and appropriate “X” space must be included in each section.

Layout Example

- 1–PRL4X panelboard, 480Y/277 volt, three-phase four-wire 65 kA, 800 A, main lug, consisting of:
 - 12–20 A/single-pole PDG2xM
 - 1–400 A/three-pole PDG3xM

Reference PRL4X Layout Example

1. From layout guide, total “X” height of panel = 26X, (which is a design standard and no rounding off is necessary).
2. From table on right, enclosure height for 26X panel = 57 inches (1447.8 mm).
3. Width = 24 inches (609.6 mm)—directly from layout guide.
4. Enclosure depth = 11.31 inches (287.0 mm)—standard for all PRL4X panelboards.

PRL4X Layout Example

20 A/1P	20 A/1P	1X
20 A/1P	20 A/1P	1X
20 A/1P	20 A/1P	1X
20 A/1P	20 A/1P	1X
20 A/1P	20 A/1P	1X
20 A/1P	20 A/1P	1X
250 A/3P		3X
250 A/3P		3X
400 A/3P		4X
Main Lugs	800 A	10X
Neutral		

Total = 26X

Box Dimensions—PRL4X

“X” Units	Catalog Number	Height	Width	Depth ①
26X	BX2457	57.00 (1447.8)	24.00 (609.6)	11.31 (287.0)
38X	BX2473	73.50 (1866.9)	24.00 (609.6)	11.31 (287.0)
50X	BX2490	90.00 (2286.0)	24.00 (609.6)	11.31 (287.0)
38X	BX3673	73.50 (1866.9)	36.00 (914.4)	11.31 (287.0)
50X	BX3690	90.00 (2286.0)	36.00 (914.4)	11.31 (287.0)
38X	BX4473	73.50 (1866.9)	44.00 (1117.6)	11.31 (287.0)
50X	BX4490	90.00 (2286.0)	44.00 (1117.6)	11.31 (287.0)

Top and Bottom Gutters

10.63-inch (269.9 mm) minimum.

Side Gutters—Minimum

24.00-inch (609.6 mm) wide box—5.00-inch (127.0 mm).
 36.00-inch (914.4 mm) wide box—6.00-inch (152.4 mm).
 44.00-inch (1117.6 mm) wide box—8.00-inch (203.2 mm).

Notes

① Box depth is 10.40 inches (264.2 mm), cover adds 0.90 inches (22.9 mm) to depth.
 800 A maximum bus size in 24.00-inch (609.6 mm) wide box. Flush trims not available on PRL4X panels.

Pow-R-Line Xpert Panelboards

Layout for Branch and Horizontally Mounted Main Devices Layout—PRL4X

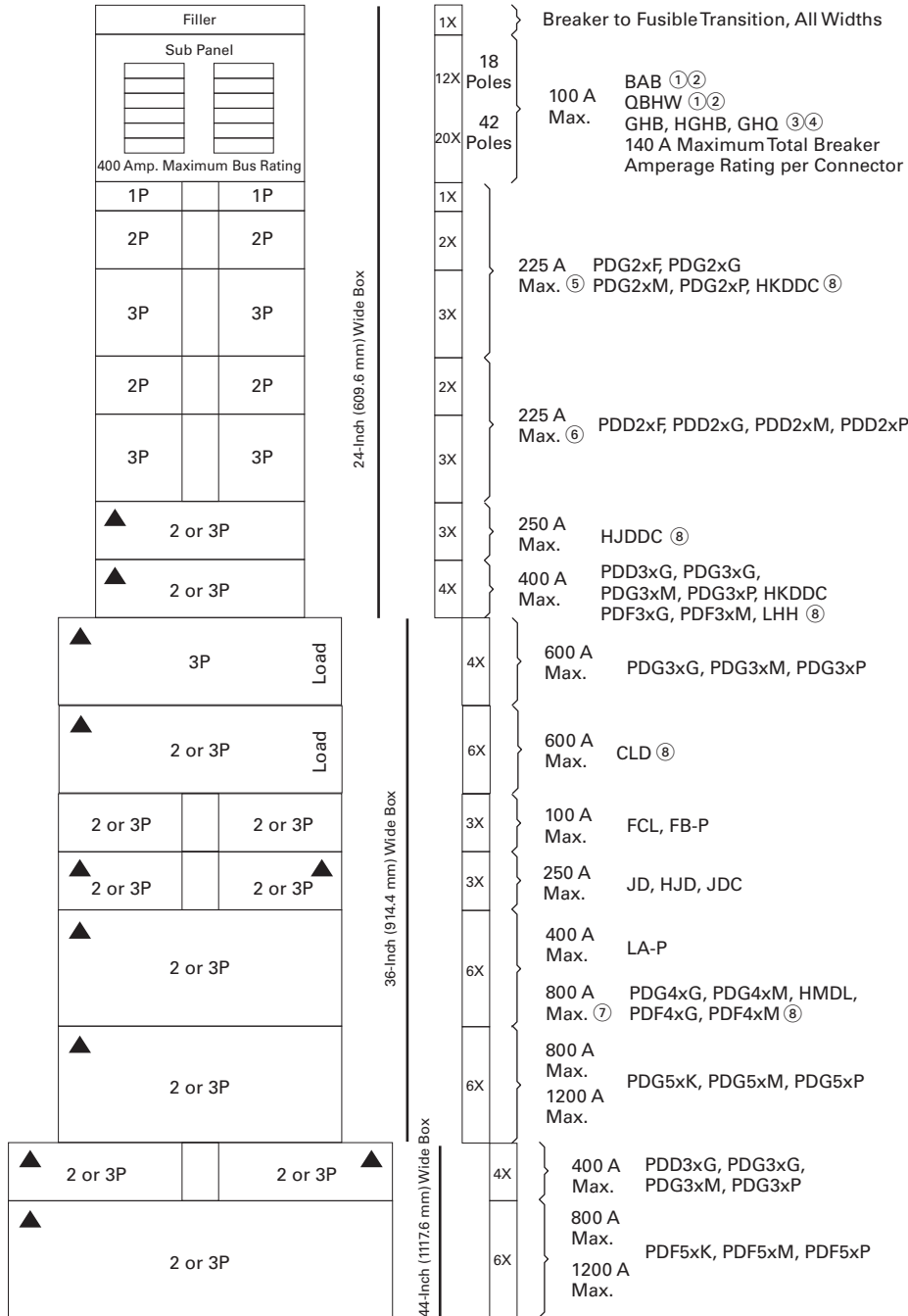

Notes

- ① BAB and QBHW breakers with shunt trips require one additional pole space, i.e., single-pole is two-pole size, two-pole is three-pole size, and three-pole is four-pole size.
- ② If panel contains only BAB or QBHW branch breakers, use a PRL1X panelboard.
- ③ GHB, HGHB or GHQ breakers cannot be mixed on same subchassis as BAB, QBHW.
- ④ If panel contains only GHB, HGHB or GHQ branch breakers, use a PRL2X panelboard.
- ⑤ When only one single-pole breaker of the group is required on either side of chassis, the single-pole breaker space required changes from 1X to 2X.
- ⑥ Minimum 36-inch (914.4 mm) wide box is required if optional #6–300 kcmil lug is required.
- ⑦ PDG4xG main breaker in 24-inch (609.6 mm) wide box, refer to **Page V2-T3-66**.
- ⑧ For use on DC systems only.

See **Page V2-T3-66** for MLO or Neutral and Vertically Mounted Mains space requirements.

Box Sizing and Selection—PRL4F

Approximate Dimensions in Inches (mm)

Main Lug Only (MLO), Main Switch, Neutral, Through-Feed (TFL) and Sub-Feed Lug (SFL) "X" Space Requirements. (For other configurations not shown, refer to Eaton.)

* = Space available for branch devices. For device sizing, see **Page V2-T3-71**.

● = Blank means no bus under cover, to meet NEC cable bending space.

PRL4F Layout

Standard Main Lug, Through-Feed and Sub-Feed Lugs ① (500 kcmil Maximum)

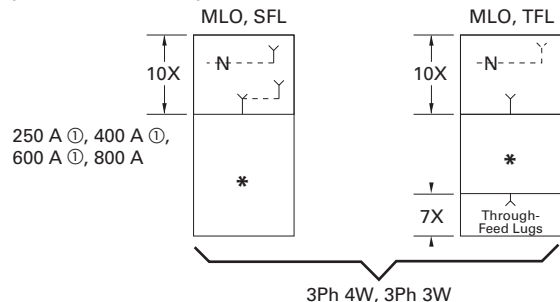

Main Switch with Neutral (when required) (500 kcmil Maximum)

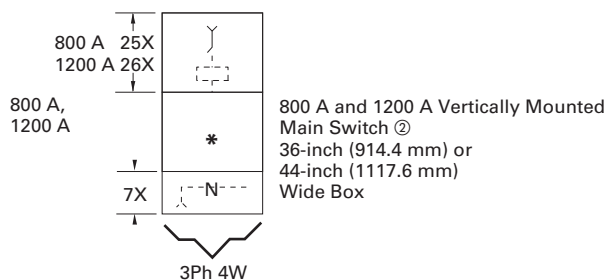
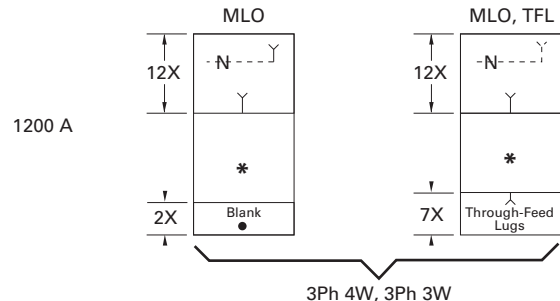
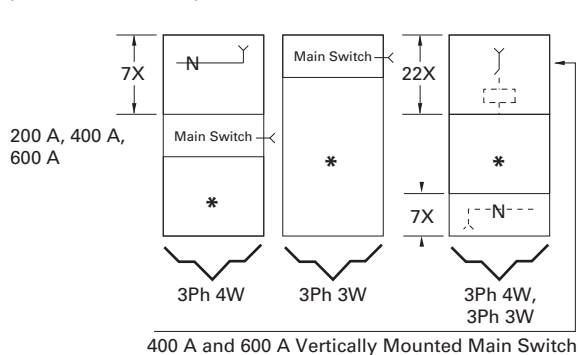

Optional Main Lugs, Through-Feed and Sub-Feed Lugs ① (750 kcmil Maximum)

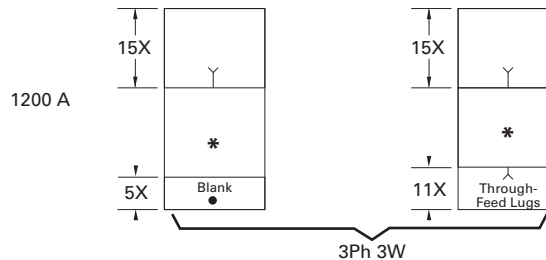
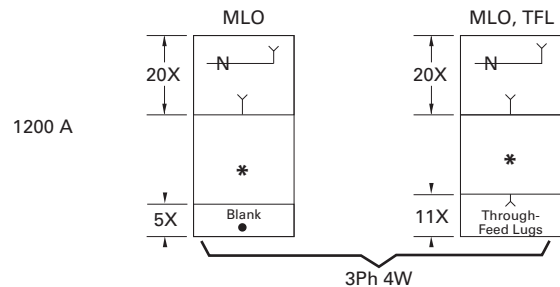
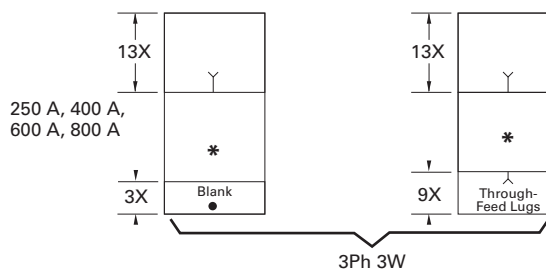
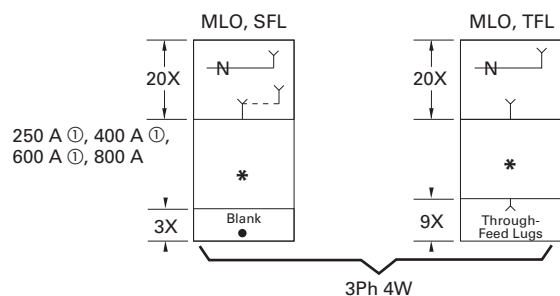

Notes

① Sub-feed lugs are available 250–600 A. For 600 A, use 1200 A "A" space.

② 800 A and 1200 A mains available only in vertical mounting.

3.3

Panelboards and Lighting Control

Pow-R-Line Xpert Panelboards

Approximate Dimensions in Inches (mm)

Panel Layout and Dimensions

To determine the dimensions of a given panelboard enclosure, make a layout sketch by fitting together the main, branch and lug modules according to the appropriate tables in the layout guide. Assign "X" units to each module as shown and obtain a total "X" number.

The height of the enclosure is related to the total "X" units in the layout as shown in table on right. Three standard box heights are available to accommodate any and all layout arrangements. "X" unit totals that do not exactly match those in table on right must be rounded off to the next higher standard (38X, 50X).

If a calculated "X" total for a panel exceeds 50X, the panel must be split into two or more separate sections with "X" space for through-feed lugs figured in for all but one section. If a neutral is required, a separate neutral bar and appropriate "X" space must be included in each section.

Layout Example

- PRL4F, three-phase four-wire, 208Y/120 volt complete with 400 A main switch and the following branches:
 - One 200 A/three-pole
 - Two 100 A/three-pole
 - Two 30 A/three-pole

Panel to have short-circuit rating of 100 kA symmetrical.

Reference PRL4F Layout Example

- From layout guide, total "X" height of panel = 43X.
- Rounded off to next higher standard = 50X.
- From table on right, enclosure height for 50X panel = 90 inches (2286.0 mm).
- Width = 36 inches (914.4 mm).
- Enclosure depth is standard for all PRL4X panelboards = 11.31 inches (287.0 mm).

Type PRL4F Layout Example

400 A Neutral	7X	
30 A/3P	30 A/3P	4X
100 A/3P	100 A/3P	5X
200 A/3P	6X	
400 A three-pole Main Switch (Vertical Mounted)	21X	

Total = 43X

Box Dimensions—PRL4F

"X" Units	Catalog Number	Height	Width	Depth ^①
38X	BX3673	73.50 (1866.9)	36.00 (914.4)	11.31 (287.0)
50X	BX3690	90.00 (2286.0)	36.00 (914.4)	11.31 (287.0)
38X	BX4473	73.50 (1866.9)	44.00 (1117.6)	11.31 (287.0)
50X	BX4490	90.00 (2286.0)	44.00 (1117.6)	11.31 (287.0)

Top and Bottom Gutters

10.63 inches (269.9 mm) minimum.

Side Gutters—Minimum

- 36-inch (914.4 mm) wide box:
 - 8-inch (203.2 mm)—200 A maximum
 - 6-inch (152.4 mm)—400–1200 A maximum
- 44-inch (1117.6 mm) wide box:
 - 10-inch (254.0 mm)—200 A maximum
 - 8-inch (203.2 mm)—400–1200 A

Notes

- ^① Box depth is 10.40-inch (264.2 mm), cover adds 0.90-inch (22.8 mm) to depth. Flush trims not available on PRL4F panels.

Layout for Branch and Horizontally Mounted Main Device—PRL4F

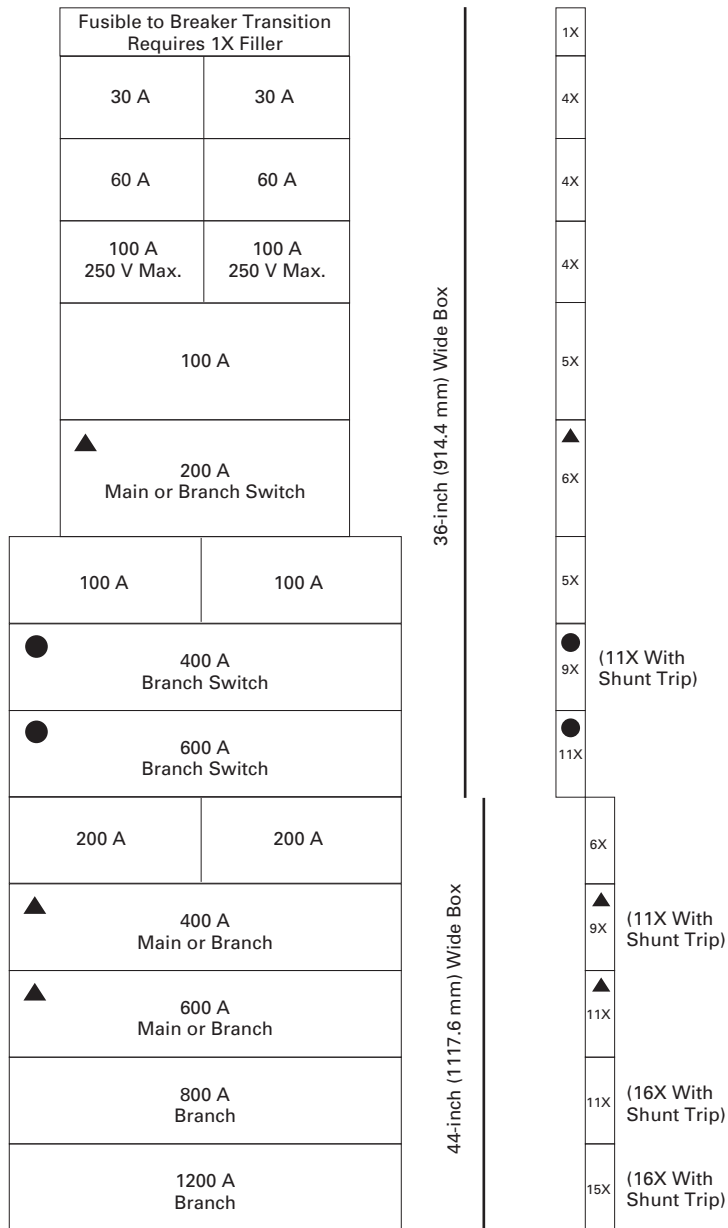

- ▲ Fusible switch may be used as horizontally main.
 - 400 and 600 A horizontally mounted feeder switches in 36-inch (914.4 mm) or 44-inch (1117.6 mm) wide box. 400 and 600 A horizontally mounted main switches only in 44-inch (1117.6 mm) wide box. For vertically mounted main, see **Page V2-T3-69** for sizing.
- Note:** See **Page V2-T3-69** for MLO or Neutral and Vertically Mounted Main space requirements.

Type PRL4DX



Type PRL4DX Drawout Molded Case Circuit Breaker Power Panelboard

3

Type PRL4DX

Product Description

- Drawout molded case circuit breaker power panelboard
- Front accessible
- Front connected
- Through-the-door design drawout mechanism
- Visual indication of breaker status and position
- Large grab handles for easy removal
- 600 Vac maximum
- 1200 A maximum mains
- 600 A maximum drawout molded case feeder breakers

Application Description

- Interrupting ratings up to 200 kAIC symmetrical
- Feeder power panelboard
- Rated as Service Entrance Equipment when appropriately equipped
- Ideal for:
 - Data centers
 - Industrial facilities
 - Process equipment manufacturing
 - Anywhere that requires quick change of feeder devices

Contents

Description

	<i>Page</i>
Product Description	V2-T3-7
Application Description	V2-T3-8
Standards and Certifications	V2-T3-10
Power Xpert Release Trip Unit for Molded Case Circuit Breakers	V2-T3-11
Standards and Certifications	V2-T3-10
Type PRL1X	V2-T3-18
Type PRL1XF	V2-T3-22
Type PRL1X-LX	V2-T3-25
Type PRL2X	V2-T3-29
Type PRL2XF	V2-T3-33
Type PRL2X-LX	V2-T3-36
Retrofit Panelboard	V2-T3-40
Type PRL3E	V2-T3-48
Type PRL3X	V2-T3-52
Type PRL3XF	V2-T3-56
Type PRL3FQS	V2-T3-59
Type PRL4X	V2-T3-62
Type PRL4DX Product Selection	V2-T3-73
Box Sizing and Selection—PRL4DX	V2-T3-76
Accessories and Modifications	V2-T3-79

Benefits

- Ease of maintenance
- Faster to remove and install
- Less downtime

Standards and Certifications

- UL 67 Listed chassis
- UL 50 Listed box and trim



Product Selection

Type PRL4DX



PRL4DX Main Lugs and Main Breakers

Ampere Rating	Interrupting Rating (kA Symmetrical)			Breaker Type	"X" Space
	240 Vac	480 Vac	600 Vac		
Main Lugs Only (Fixed-Mounted Only)					
400	—	—	—	—	10X
600	—	—	—	—	10X
800	—	—	—	—	10X
1200	—	—	—	—	12X
Main Circuit Breaker (Drawout Only) ①					
600	65	35	18	PDG3xG ③	9X
600	100	65	35	PDG3xM ③	9X
600	200	100	50	PDG3xP ③	9X
Main Circuit Breaker (Fixed-Mounted Only) ①					
600	65	35	18	PDG3xG ③	4X
600	100	65	35	PDG3xM ③	4X
600	200	100	50	PDG3xP ③	4X
600	65	35	25	CLD ②	6X
800	65	35	18	PDG4xG	6X
800	100	65	35	PDG4xM	6X
800	65	35	18	PDF4xG ②	6X
800	100	65	35	PDF4xM ②	6X
1200	85	50	25	NGS	6X
1200	100	65	35	PDG5xM	6X
1200	200	100	65	PDG5xP	6X
1200	65	50	25	CND ②	6X

Notes

- ① For ground fault protection on main devices, see Modification 10—applies to 310 and 310+ trip units only.
- ② 100% rated circuit breaker.
- ③ The 400 A frame must use trip units of ratings 100–400, while the 600 A frame must use trip units of ratings 500, 600 or designated by H, such as H250. The H as the leading character of the ampacity indicates a high instantaneous version of the breaker for coordination purposes. H ratings must use 600 A frame.

Pow-R-Line Xpert Panelboards

PRL4DX Drawout Branch/Feeder Breakers

Type PRL4DX

Single Mount Two-Pole and Three-Pole

Interrupting Rating (kA Symmetrical)

Ampere Rating	Interrupting Rating (kA Symmetrical)			Breaker Type	"X" Space
	240 Vac	480 Vac	600 Vac		
Single-Mount Breakers with Thermal-Magnetic Trip Units					
70–250	85	35	18	JGS	7X
70–250	100	65	25	JGH	7X
70–250	200	100	35	JGC	7X
250–600	85	35	18	LGS	9X
250–600	100	65	35	PDG3xM ^①	9X
250–600	200	100	65	PDG3xP ^①	9X
Single-Mount Breakers with Electronic 310+ Trip Units (Three-Pole Only)					
20–50	85	35	18	JGS	7X
20–50	100	65	25	JGH	7X
20–50	200	100	35	JGC	7X
40–100	85	35	18	JGS	7X
40–100	100	65	25	JGH	7X
40–100	200	100	35	JGC	7X
80–150	85	35	18	JGS	7X
80–150	100	65	25	JGH	7X
80–150	200	100	35	JGC	7X
100–250	85	35	18	JGS	7X
100–250	100	65	25	JGH	7X
100–250	200	100	35	JGC	7X
100–250	85	35	18	LGS	9X
100–250	100	65	35	PDG3xM ^①	9X
100–250	200	100	65	PDG3xP ^①	9X
200–400	85	35	18	LGS	9X
200–400	100	65	35	PDG3xM ^①	9X
200–400	200	100	65	PDG3xP ^①	9X
250–600	85	35	18	LGS	9X
250–600	100	65	35	PDG3xM ^①	9X
250–600	200	100	65	PDG3xP ^①	9X
Provision for Future (Includes Factory-Installed Base Cassette)					
20–250	Any JG family branch/feeder breaker				7X
100–600	Any LG family branch/feeder breaker				9X

Note

^① The 400 A frame must use trip units of ratings 100–400, while the 600 A frame must use trip units of ratings 500, 600 or designated by H, such as H250. The H as the leading character of the ampacity indicates a high instantaneous version of the breaker for coordination purposes. H ratings must use 600 A frame.

For Dual/Twin feeder breakers, select any two breakers within the same “Breaker Type.”

Type PRL4DX



Dual/Twin Mount Two-Pole and Three-Pole

Ampere Rating	Interrupting Rating (kA Symmetrical)			Breaker Type	"X" Space
	240 Vac	480 Vac	600 Vac		
Dual-/Twin-Mount Breakers with Thermal-Magnetic Trip Units					
70–250	85	35	18	JGS	7X
70–250	100	65	25	JGH	7X
70–250	200	100	35	JGC	7X
Dual-/Twin-Mount Breakers with Electronic 310+ Trip Units (Three-Pole Only)					
20–50	85	35	18	JGS	7X
20–50	100	65	25	JGH	7X
20–50	200	100	35	JGC	7X
40–100	85	35	18	JGS	7X
40–100	100	65	25	JGH	7X
40–100	200	100	35	JGC	7X
80–150	85	35	18	JGS	7X
80–150	100	65	25	JGH	7X
80–150	200	100	35	JGC	7X
100–250	85	35	18	JGS	7X
100–250	100	65	25	JGH	7X
100–250	200	100	35	JGC	7X
Provision for Future (Includes Factory-Installed Base Cassette)					
20–250	Any JG Family Branch/Feeder Breaker				7X
100–600	Any LG Family Branch/Feeder Breaker				9X

3.3

Panelboards and Lighting Control

Pow-R-Line Xpert Panelboards

Box Sizing and Selection—PRL4DX

Approximate Dimensions in Inches (mm)

Main Lug Only (MLO), Main Breaker, Neutral, Through-Feed Lug (TFL) and Sub-Feed Lug (SFL) "X" Space Requirements. (For other configurations not shown, refer to Eaton.)

* = Space available for branch devices. For device sizing, see **Page V2-T3-78**.

● = Blank means no bus under cover, to meet NEC cable bending space.

PRL4DX Layout

Standard Main Lug, Through-Feed and Sub-Feed Lugs (500 kcmil Maximum)

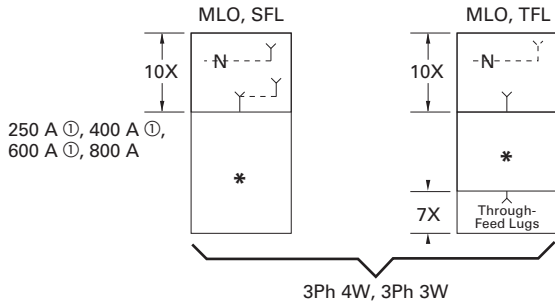

Main Breaker with Neutral (when required) (500 kcmil Maximum)

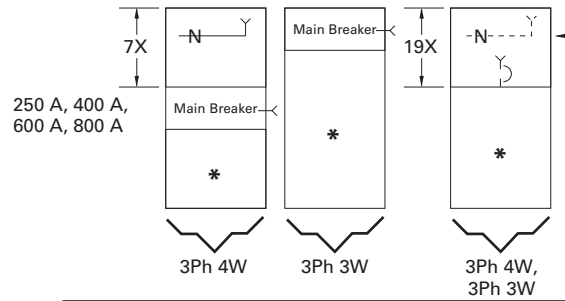

800 A Vertically Mtd. PDG4xG Main Breaker only in 24-inch (609.6 mm) wide box. Available with 38X and 50X Panel Height only.

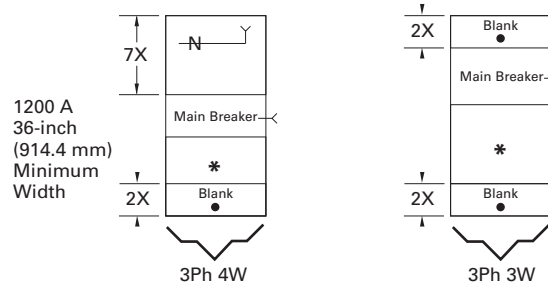
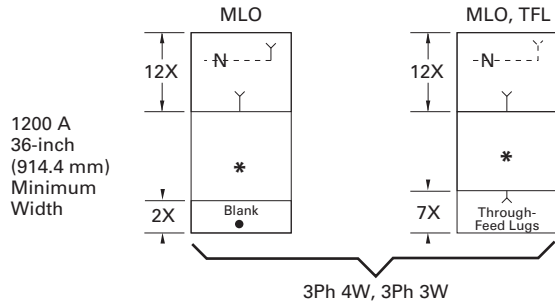

Optional Main Lugs, Through-Feed and Sub-Feed Lugs (750 kcmil Maximum)

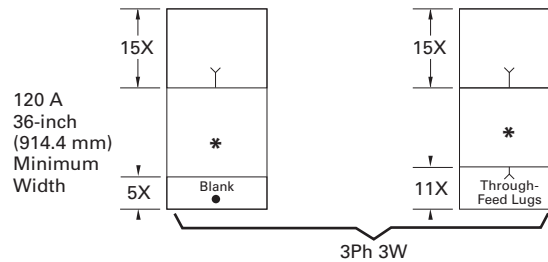
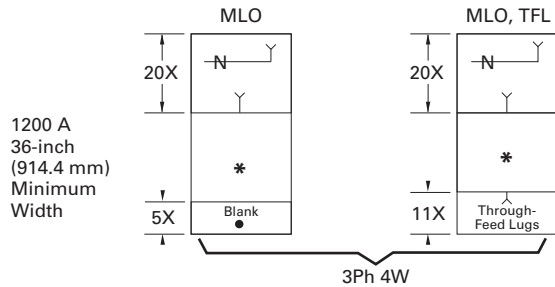
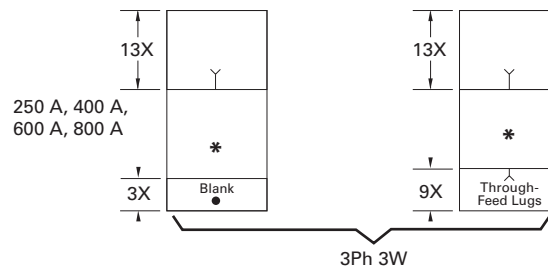
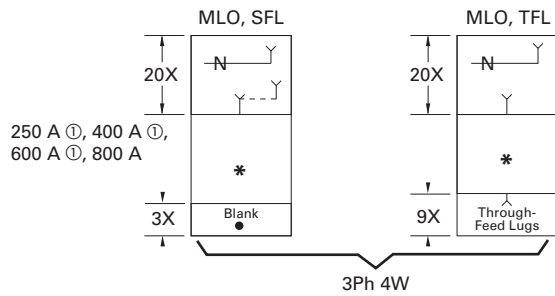

Note

① Sub-feed lugs are available 250–600 A. For 600 A, use 1200 A "A" space.

Approximate Dimensions in Inches (mm)

Panel Layout and Dimensions

To determine the dimensions of a given panelboard enclosure, make a layout sketch by fitting together the main, branch and lug modules according to the appropriate tables in the layout guide. Assign “X” units to each module as shown and obtain a total “X” number.

The height of the enclosure is related to the total “X” units in the layout as shown in table on right. Three standard box heights are available to accommodate any and all layout arrangements. “X” unit totals that do not exactly match those in table on right must be rounded off to the next higher standard (38X, 50X).

If a calculated “X” total for a panel exceeds 50X, the panel must be split into two or more separate sections with “X” space for through-feed lugs figured in for all but one section. If a neutral is required, a separate neutral bar and appropriate “X” space must be included in each section.

Layout Example

- One PRL4DX panelboard, 480Y/277 Vac, three-phase, four-wire, 65 kA, 800 A main lugs only with:
 - One JGS 200 A/ three-pole
 - One LGS 400 A/ three-pole
 - One JGS 150 A/ three-pole dual mount
 - One JGS 100 A/ three-pole dual mount

Reference PRL4DX Layout Example

1. From layout guide, total “X” height of panel = 33X.
2. From table on right, 33X must use minimum 38X dimensions. Minimum box height is 73.50 inches (1866.9 mm).
3. From the layout for branch and main devices, find minimum box width requirements for mains and branch/feeder devices.
 - JGS single minimum width: 36 inches
 - LGS single minimum width: 36 inches
 - JGS dual minimum width: 44 inches

As the JGS duals require a minimum of a 44-inch-wide box, the minimum box width is 44 inches.
4. From PRL4DX Layout Example, the correct minimum box selection is BX4473, which is 73.50 inches H x 44.00 inches W x 11.31 inches D (1866.9 mm H x 1117.6 mm W x 287.0 mm D).

Box Dimensions—PRL4DX

“X” Units	Catalog Number	Height	Width	Depth ①
38X	BX3673	73.50 (1866.9)	36.00 (914.4)	11.31 (287.0)
50X	BX3690	90.00 (2286.0)	36.00 (914.4)	11.31 (287.0)
38X	BX4473	73.50 (1866.9)	44.00 (1117.6)	11.31 (287.0)
50X	BX4490	90.00 (2286.0)	44.00 (1117.6)	11.31 (287.0)

Top and Bottom Gutters

10.63 inches (269.9 mm) minimum.

Side Gutters—Minimum

- 36-inch (914.4 mm) wide box: 6-inch (152.4 mm)
- 44-inch (1117.6 mm) wide box: 8-inch (203.2 mm)

Type PRL4DX Layout Example

JGS 200 A three-pole single feeder		7X
LGS 400 A three-pole single feeder		9X
JGS 150 A three-pole dual feeder	JGS 150 A three-pole dual feeder	7X
Main Lugs	800 A	10X
Neutral		
Total =		33X

Notes

- ① Box depth is 10.40-inch (264.2 mm), cover adds 0.90-inch (22.8 mm) to depth. Flush trims not available on PRL4DX panels. Door-to-door option not available on PRL4DX panels.

3.3

Panelboards and Lighting Control

Pow-R-Line Xpert Panelboards

Layout for Branch and Horizontally Mounted Main Devices—PRL4DX

Instructions

Determine box size by locating all main and feeder devices in your panel. The width of box is determined by the maximum box size shown for each device. For main lugs, through-feed lugs and sub-feeder lugs, refer to **Page V2-T3-76**.

3

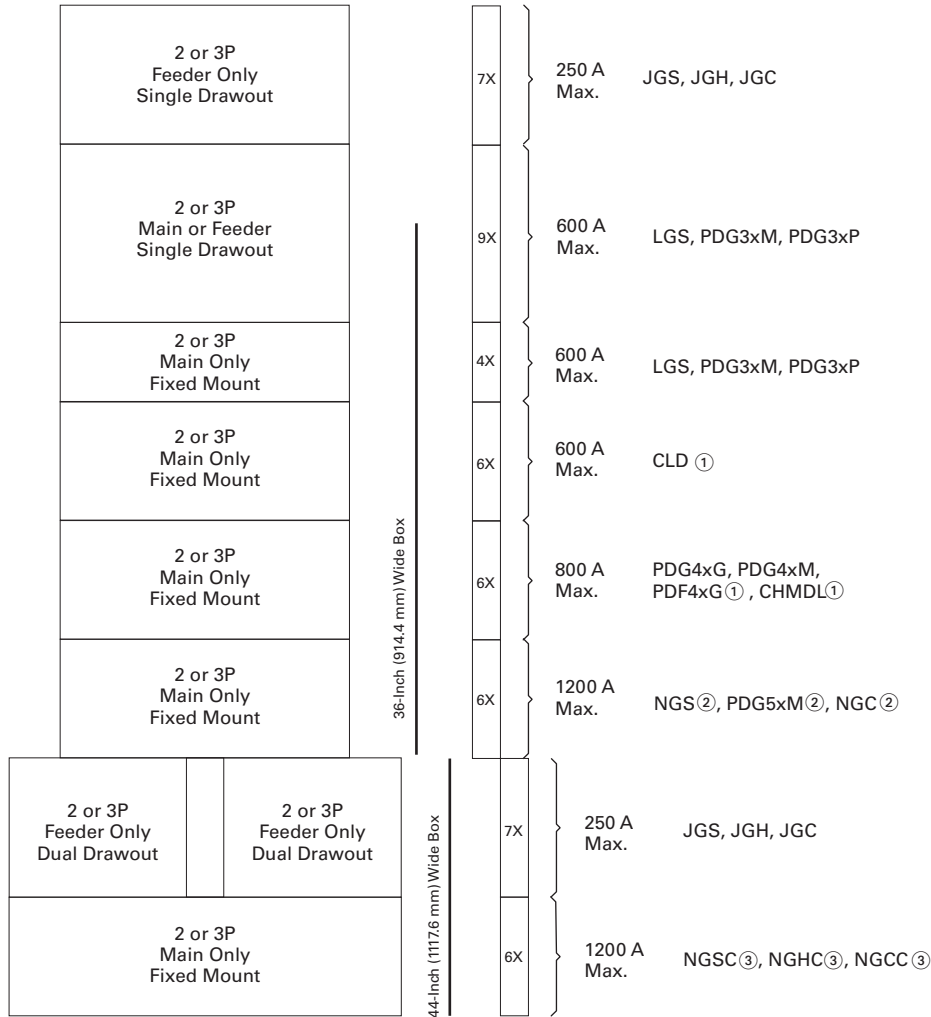

Notes

- ① 100% rated breaker.
- ② Optional 750 kcmil terminal requires 44-inch (1117.6 mm) wide box.
- ③ Contact Eaton for availability.

Accessories and Modifications

PRL4DX Modifications

Modification	Item Number
Ambient compensating breakers	1
Breaker accessories—internal	2
Complete assembly	3
Compression type lugs	4
Conduit covers	5
Copper lugs/terminals	6
Copper main bus	7
Density rated bus	8
Directory frame—metal	9
Electronic trip units	10
Ground bars	11
Ground fault protection	12
Infrared (IR) viewing windows	13
Handle lock-off device	14
Nameplates	15
Permanent circuit numbers	16
Seismically qualified	17
Service entrance equipment rated	18
Shunt trips	19
Sub-feed lugs	20
Surge protective devices	21
Through-feed lugs	22
Touchup paint	23

1. Ambient Compensating Breakers

For ambient compensating breakers (where available) in lieu of standard breakers, add 10 percent to panelboard branch breaker and to main breaker list prices, if required. (Not UL Listed.)

2. Breaker Accessories—Internal (Only One Accessory Per Position)

Accessories

Breaker Type	Device Mounting	Internal Breaker Accessory
JG family	Drawout ①	Auxiliary switch 1A-1B
JG family	Drawout ①	Auxiliary switch 2A-2B
JG family	Drawout ①	Bell alarm
JG family	Drawout ①	High load alarm w/trip
JG family	Drawout ①	Ground fault alarm w/trip
JG family	Drawout ②	Undervoltage release
JG family	Drawout ②	Zone selective interlock
LG family	Drawout ①	Auxiliary switch 1A-1B
LG family	Drawout ①	Auxiliary switch 2A-2B
LG family	Drawout ①	Bell alarm
LG family	Drawout ①	High load alarm w/trip
LG family	Drawout ①	Ground fault alarm w/trip
LG family	Drawout ②	Undervoltage release ③
LG family	Drawout ②	Zone selective interlock
LG family	Fixed	Auxiliary switch 1A-1B
LG family	Fixed	Auxiliary switch 2A-2B
LG family	Fixed	Bell alarm
LG family	Fixed	High load alarm w/trip
LG family	Fixed	Ground fault alarm w/trip
LG family	Fixed	Undervoltage release ③
LG family	Fixed	Zone selective interlock
PDG4xG family	Fixed	Auxiliary switch 1A-1B
PDG4xG family	Fixed	Auxiliary switch 2A-2B
PDG4xG family	Fixed	Auxiliary switch 1A-1B w/alarm
PDG4xG family	Fixed	Auxiliary switch 2A-2B w/alarm
NG family	Fixed	Auxiliary switch 1A-1B
NG family	Fixed	Auxiliary switch 2A-2B
NG family	Fixed	Bell alarm
NG family	Fixed	High load alarm w/trip
NG family	Fixed	Ground fault alarm w/trip
NG family	Fixed	Undervoltage release ③
NG family	Fixed	Zone selective interlock

Notes

- ① Accessories wired to a pull-apart terminal block. Right position only.
- ② Accessories wired to a pull-apart terminal block. Left position only.
- ③ Not available when breaker is equipped with Arcflash Reduction Maintenance System trip unit.

Pow-R-Line Xpert Panelboards

3. Complete Assembly

Complete assembly of panelboard box, interior and trim prior to shipment, when requested on order.

4. Compression Main Lugs

Al/Cu Burndy range-taking type.

Modification 4

Main Lug Amperes	PRL4DX Lug Wire Range
800	(3) 500–750 kcmil
1200	(4) #2–600 kcmil (4) 500–750 kcmil

5. Conduit Covers

Fabricated sheet metal to cover open conduits above and/or below standard Type 1 box.

Modification 5

Description
Conduit enclosing shield—open back
Conduit enclosing shield—solid back

6. Copper Lugs/Terminals

Optional copper mechanical main lugs only and includes main incoming neutral lug.

Modification 6

Main Lug Amperes	PRL4DX Lug Wire Range
600	(2) 1/0–600 kcmil
800	(2) 1/0–600 kcmil
1200	(3) 1/0–600 kcmil

7. Copper Main Busbars

Optional copper busbars are available in all ampere ratings.

Modification 7

Ampere Range	Bare Copper Chassis Bus	Silver-Plated Copper Bus
600		
800		
1000		
1200		

8. Density Rated Bus

Standard main bus ampere rating is determined by UL listed temperature rise testing. Density rated bus is defined at 750 A per square inch for aluminum bus and 1000 A per square inch for copper bus. Adder for aluminum density rated bus is in addition to the base price. Adder for copper density rated bus is in addition to the base price plus the appropriate adder for copper bus. See Modification 7.

Modification 8

Ampere Rating
Aluminum—750 A per Square Inch
600
800
1000
1200
Copper—1000 A per Square Inch
600
800
1000
1200

9. Directory Frame—Metal

Metal directory frame in lieu of standard non-metallic pocket directory holder.

Modification 9

Directory Frame Type
Metal frame, plastic cover

10. Electronic Trip Units

Thermal-magnetic trip units are standard. For electronic trip units, select appropriate breaker from the electronic trip section of **Pages V2-T3-74 and V2-T3-75**. See selection below for electronic trip units.

Modification 10

Breaker Frame Family	Trip Unit Type
Drawout Feeder JGS, JGH, JGC	Digitrip 310+ LS Digitrip 310+ LSI Digitrip 310+ LSG Digitrip 310+ LSIG
Drawout Feeder or Main LGS, PDG3xM, PDG3xP	Digitrip 310+ LS Digitrip 310+ LSI Digitrip 310+ LSG Digitrip 310+ LSIG

The following electronic trip units integrate Eaton's Arcflash Reduction Maintenance System within the trip unit.

Breaker Frame Family	Trip Unit Type
Drawout Feeder or Main LGS, PDG3xM, PDG3xP	Digitrip 310+ ALSI Digitrip 310+ ALSIG

Electronic Trip Units for Fixed-Mounted Mains Only.

Breaker Frame Family	Trip Unit Type	Trip Unit Functionality ^①
LGS, PDG3xM, PDG3xP	Digitrip 310+ Digitrip 310+ Digitrip 310+ Digitrip 310+ Digitrip 310+ Digitrip 310+	LS LSI LSG LSIG ALSI ^② ALSIG ^②
CLD	Digitrip 310 Digitrip 310 Digitrip 310 Digitrip 310	LS LSI LSG LSIG
PDG4xG, PDG4xM, PDF4xG, PDF4xM	Digitrip 310 Digitrip 310 Digitrip 310 Digitrip 310	LS LSI LSG LSIG
NGS, PDG5xM, PDG5xP	Digitrip 310+ ^③ Digitrip 310+ ^③ Digitrip 310+ ^③ Digitrip 310+ ^③ Digitrip 310+ ^③ Digitrip 310+ ^③	LS LSI LSG LSIG ALSI ^② ALSIG ^②
CND	Digitrip 310 ^④ Digitrip 310 ^④ Digitrip 310 ^④ Digitrip 310 ^④	LS LSI LSG LSIG

11. Ground Bars

Modification 11

Description	Bar Type
Aluminum bar for aluminum and copper conductors	Standard, attached to box Insulated/isolated ground bar
Copper bar for use with copper only conductors	Standard, attached to box Insulated/isolated bar

Notes

- ① L = Adjustable long delay pickup
S = Adjustable short delay pickup w/fixed short delay
I = Adjustable instantaneous pickup
G = Adjustable ground fault pickup
A = Arcflash Reduction Maintenance System
- ② Trip unit includes Arcflash Reduction Maintenance System.
- ③ Digitrip 310+ is standard for the NGS, PDG5xM and PDG5xP.
- ④ Digitrip 310 is standard for CND.

12. Ground Fault Protection

Refer to Modification 10 for ground fault trip units.

13. Infrared (IR) Viewing Windows

Infrared viewing windows for main devices and drawout single-mounted feeder devices.

Modification 13

Overcurrent Device	IR Window Manufacturer
All fixed mount mains	Iriss Hawk (Fluke)
Single drawout feeder breakers ①	Iriss Hawk (Fluke)

14. Handle Lock-Off Devices for Breakers

Contact Eaton for a list of padlockable and non-padlockable circuit breaker handle lock-offs.

15. Nameplates, Engraved

Field-attached nameplates.

Modification 15

Description
Mastic back, engraved, black with white lettering
Mastic back, engraved, colors other than black
Nameplates, screw attached

16. Permanent Circuit Numbers

Permanently attached micarta circuit numbering.

17. Seismically Qualified

For seismically qualified PRL4DX panelboards, request seismic labeling on order.

18. Service Entrance Equipment

Service Entrance labeling as detailed under the “Service Entrance Equipment” per UL and NEC. Only panelboards meeting these requirements may be labeled as such. The requirement or service entrance labeling must be noted on the order. Includes neutral disconnect link and labeling “Suitable For Use as Service Equipment” (SUSE). Ground bar must be ordered separately. See Modification 11.

19. Shunt Trip for Main or Feeder Breakers

For tripping breaker from remote point. Voltage and frequency must be specified when ordering shunt trips. Wiring to terminal block is included with the drawout molded case product as standard. For all others wired to terminal block, contact Eaton.

20. Sub-Feed Lugs

Available only on main-lug-only panelboards.

Not available on service entrance panelboards with main lugs using the six disconnect rule.

Mechanical Al/Cu lugs. Compression or copper body lugs require additional price adder from Modification 4 or Modification 6, as appropriate.

Modification 20

Panel Ampere Rating	Box Height Addition
600	4X
800	6X

21. Surge Protective Devices (SPD)

Package includes SPD unit and integral circuit breaker disconnect (30 A) connected to the chassis bus.

Modification 21

Surge Current Rating	50	80	100	120	160	200	250	300	400
SPD Package Options—Basic Package									
LED monitor, L-N, L-G, L-L and N-G	■	■	■	■	■	■	■	■	■
Standard Package									
LED monitor, L-N, L-G, L-L and N-G. EMI/RFI filtering. Audible alarm with disable switch. Form C relay contact.	■	■	■	■	■	■	■	■	■
Premium Package									
LED monitor, L-N, L-G, L-L and N-G. EMI/RFI filtering. Audible alarm with disable switch. Form C relay contact. Six-digit LCD display. Counts surges in all modes. Nonvolatile memory (no battery backup). Reset button designed to prevent accidental resets.	■	■	■	■	■	■	■	■	■

22. Through-Feed Lugs

Mechanical Al/Cu lugs. Compression or copper lugs require additional price adder from Modification 4 Compression Lug or Modification 6 Copper Lugs/Terminals.

Modification 22

Refer to PRL4DX Layout.

Panel Main Ampere Rating	Box Height Addition
600	7X
800	7X
1200	9X

23. Touchup Paint

Modification 23

Description
12 oz spray can. ANSI-61 light gray indoor
Case lot of 12—12 oz spray can. ANSI-61 light gray indoor

Note

① Available on only single-mounted drawout. Not available on dual-mounted feeder devices.

Power Xpert Multipoint Meter



3

Contents

<i>Description</i>	<i>Page</i>
Power Xpert Multipoint Meter	
Features, Benefits and Functions	V2-T3-83
Standards and Certifications	V2-T3-83
Product Selection	V2-T3-83
Options	V2-T3-83

Overview

Allocation of energy consumption in a residential or commercial application is a tremendous task for a property owner, management firm or electrical energy manager. Eaton’s Power Xpert Multipoint Meter solution can assist in allocation or direct billing of consumed energy. The Power Xpert Multipoint Meter provides a cost-effective energy tabulation system for residential or commercial metering installations, including:

- High-rise buildings
- Universities and campuses
- Office buildings
- Apartment and condominium complexes
- Shopping malls
- Airports

Eaton’s Power Xpert Multipoint Meter can provide accurate information of consumed energy for monthly statements. Using the Power Xpert Multipoint Meter for utility allocation maximizes revenue by effectively measuring, allocating and recovering utility expenditures. The Power Xpert Multipoint Meter solution can interface with a third-party utility allocation service and offers the following advantages:

- Purchase energy at bulk rates while charging consumer rates
- Capitalize on naturally variable tenant loads by purchasing energy at a lower coinciding load
- Capture and allocate common area maintenance cost
- Promote tenant retention with accurate and defensible billing
- Eliminate subsidization of other tenants

Product Description

Eaton’s Power Xpert Multipoint Metering Panelboard design simplifies the task of multiple tenant sub-metering. The Power Xpert Multipoint Metering Panelboard combines the Power Xpert Multipoint Meter and Eaton’s PRL4X, PRLC or Integrated Facility System™ (IFS) to provide a space-saving, cost-effective energy tabulation system for residential or commercial metering installations.

Application Description

With energy cost on the rise, it is vital to proactively monitor and conserve electrical energy. Documentations of electrical energy usage can promote energy conservation for tenants or business departments.

When the need for accurate energy consumption information for monthly tenant invoicing arises, Eaton’s Power Xpert Multipoint Metering Panelboard is the solution. The Power Xpert Multipoint Meter allocates the utility’s energy consumption, maximizing revenue by effectively measuring, allocating and recovering utility expenditures.

The Power Xpert Multipoint Meter, using Eaton’s cost-allocation software or a third-party billing software, can generate single-rate or multi-rate billing.

Features, Benefits and Functions

The Power Xpert Multipoint Metering Panelboard offers the property owner or the property management firm the following benefits:

- Capture and allocate common area maintenance cost
- Promote tenant retention with accurate billing
- Eliminate subsidization of other tenants
- Factory-wired system
- Save floor space
- Lower installed cost
- Network compatible
- Tenant sub-billing

The Power Xpert Multipoint Metering Panelboard space-saving design reduces the need for multi-metering equipment for each tenant. Additionally, the Power Xpert Multipoint Meter can monitor loads up to 5000 A for energy billing or cost allocation.

The meter is rated per ANSI C12.20 for revenue metering grade accuracy. With built-in communications capabilities, the Power Xpert Multipoint Meter can be connected to a local PC or network.

The Power Xpert Multipoint Meter can connect to a third-party billing service to provide monthly energy consumption charges used by tenants. Additionally, unit status and communication activity are provided by a display on the meter compartment front panel.

The Power Xpert Multipoint Meter device can measure up to 60 total poles in any combination of single-, two- or three-pole breakers. The meters and current sensors are factory mounted with the current sensors factory wired to the meter inside the host structure. The meter monitors power and energy including instantaneous (kW), demand and cumulative (kWh) measurements for each load. The meter provides the following:

- Interval energy data logging
- Time-of-use energy registers
- Coincident peak demand storage
- Schedule remote meter reading data in non-volatile memory
- Measure bus voltage

Standards and Certifications

- UL Listed
- UL 67 Listed chassis
- UL 50 Listed box and trim



Product Selection

For more information, refer to Eaton's *Pow-R-Line 4X Panelboard Design Guide (DG014003EN)*. For complete application and pricing information, contact your local Eaton sales office.

Options

- Energy Portal Module or Ethernet-based communications plus Modbus TCP and BACnet/IP
- Pulse input module for WAGES input
- Digital Output module for programmable alarm functions

Pow-R-Line Xpert PXBCM Panelboard

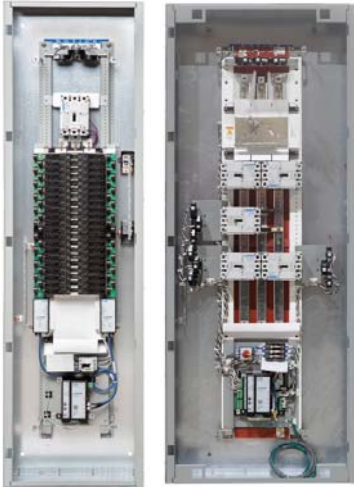

Product Description

Eaton’s Pow-R-Line Xpert™ Branch Circuit Monitoring (PXBCM) panelboard is an integrated, affordable metering device that combines exceptional performance and easy installation to deliver a cost-effective solution for branch circuit level energy and power monitoring.

The Pow-R-Line PXBCM panelboard provides a means to monitor main power coming into the panelboard and up to four additional three-phase meters. The panelboard can be used in lighting appliance, power distribution panelboards and Pow-R-Command lighting control panelboards.

The Pow-R-Line PXBCM in PRL1X, PRL2X and PRL3E can monitor up to 84 branch circuits and 16 main and auxiliary panel connections.

The Pow-R-Line PXBCM in PRL3X and PRL4X can accommodate up to 25 poles of associated 333 mV secondary CTs for main or branch devices.

Application Description

The Pow-R-Line PXBCM panelboard can be used in various industries and LEED® certified buildings. There is a rapidly changing emphasis on LEED designs and the Pow-R-Line PXBCM panelboard helps you meet the measurement and verification points required by LEED and the U.S. Green Building Council. Typical applications include:

- Energy management
- Industrial monitoring
- Cost allocation
- Data center management
- Light commercial
- Industrial
- Institutions

Contents

Description

<i>Description</i>	<i>Page</i>
Branch Circuit Monitoring (PXBCM) Panelboards	
Product Selection	V2-T3-85
Technical Data and Specifications	V2-T3-86

Features and Benefits

The Pow-R-Line PXBCM panelboard offers Modbus RS-485 and TCP output standard while allowing flexibility for onboard configuration. Also, communication and data-analysis can be communicated through an integrated web server or a number of building automation sources, including Eaton’s Power Xpert and Foreseer® products.

The Pow-R-Line PXBCM panelboard allows you to:

- Make informed load shifting and load shedding decisions
- Fairly and accurately allocate energy costs to users
- Identify wasteful practices
- Decrease unnecessary energy usage
- Produce an energy profile

Key features include:

- Power and energy readings at the branch circuit level
- Integrated web server for remote monitoring and configuration
- Optional remote color touchscreen display for local readings
- Compatibility with the Power Xpert Gateway for remote monitoring

Standards and Certifications

- UL 67 Listed chassis
- UL 50 Listed box and trim



Product Selection

For more information, refer to Eaton’s panelboard design guides. For complete application and pricing information, contact your local Eaton sales office.

Pow-R-Line PXBCM Panelboard

Height

- 36 (914.4)
- 42 (1066.8)
- 48 (1219.2)
- 60 (1524.0)
- 72 (1828.8)
- 90 (2286.0)
- 57.00 (1447.8) ①
- 73.50 (1866.9) ①
- 90.00 (2286.0) ①

Width ②

- 20 (508.0)
- 28 (711.2)
- 36.00 (914.4) ①
- 44.00 (1117.6) ①

Depth ②

- 5.75 (146.1)
- 11.30 (287.0) ①

Notes

- ① Only PRL4X.
- ② Dimensions for NEMA Type 1 enclosure. For dimensions of optional NEMA enclosure, contact your Eaton distributor or sales engineer.

Meter Bases

Meter bases are available in two versions:

PXBCM Basic

- Provides essential monitoring (volts, amps, watts, VA, power factor, demand)
- Scalable for up to 100 circuits
- Secure onboard web interface for monitoring

PXBCM Energy Code

- Includes all the functionality of the PXBCM Basic
- Log data and export as CSV
- 15-minute data logging retained for three years:
 - Virtual meter power demand
 - Virtual meter forward and reverse energy
- Aggregate virtual meters into ASHRAE 90.1 or California Title 24 load groups

Parameters

Pow-R-Line Xpert PXBCM Panelboard

Measured Parameter	Main	Branch	Virtual ③
Current per phase	■	—	—
Maximum and minimum current per phase	■	—	—
Current demand per phase	■	—	—
Peak current demand per phase	■	—	—
Forward and reverse energy (kWh) per phase	■	—	—
Maximum and minimum real power (W) per phase	■	—	—
Apparent power (VA)	■	—	■
Power factor total ①	■	—	—
Power factor per phase	■	—	—
Maximum and minimum voltage (line-to-line)	■	—	—
Maximum and minimum voltage (line-to-neutral)	■	—	—
Maximum and minimum voltage (phase A)	■	—	—
Current	—	■	—
Maximum current	—	■	■
Current demand	—	■	—
Real power (W)	—	■	—
Forward and reverse real power (W) demand	—	■	■
Forward and reverse energy (kWh) per circuit	—	■	—
Maximum apparent power (kVA)	—	■	—
Power factor	—	■	■
Virtual meters	—	—	■
Average current	—	—	■
Forward and reverse energy (kWh)	—	—	■
Forward and reverse power (W) demand	—	—	■
Forward and reverse power (W) peak demand	—	—	■
Maximum real power (W)	—	—	■
Maximum apparent power (VA)	—	—	■

Note

- ① Based on a three-phase breaker rotation.

Technical Data and Specifications

Pow-R-Line Xpert PXBCM Panelboard Specifications

3

Description	Rating
Pow-R-Line 1X Ratings	
Voltage	240 Vac maximum
Main breaker	100–600 A
Main lug	100–600 A
Maximum kAIC	10–22 kA fully rated 22–200 kA series rated
Branch circuit breaker	15–100 A
Branch breaker connector	140 A
Branch circuit breaker types	BA (BAB, BAB-H), QBH (QBHW, QBHW-H), QBGFT, QBGFEP, QBHGFT, QBHGFEP, HQP, QPHW, QHPX, QPGF, QPHGF, QPGEP, QPHGFEP, BABR, QBAF, QBAG, QBHAF, QBCAF and QBHCAF
Pow-R-Line 2X Ratings	
Voltage	240 Vac, 480Y/277 Vac and 125/250 Vdc maximum
Main breaker	100–600 A
Main lug	100–600 A
Maximum kAIC	240 Vac: 65 kA fully rated 65–200 kA series rated 480Y/277 Vac: 14 kA fully rated 22–150 kA series rated 125/250 Vdc: 10–14 kA fully rated
Branch circuit breaker	15–100 A
Branch breaker connector	140 A
Branch circuit breaker types	GB, GHB, GHBGFEP, HGHB, GQ, GHQ, GHQRD ^① and GHQRSP ^①
Pow-R-Line 3E Ratings	
Voltage	240 Vac, 480Y/277 Vac or 480 Vac and 250 Vdc maximum
Main breaker	125–400 A ^②
Main lug	100–400 A ^②
Maximum kAIC	240 Vac: 20–100 kA fully rated 100–200 kA series rated 480Y/277 Vac or 480 Vac: 18–65 kA fully rated 65–100 kA series rated 250 Vdc: 10–42 kA fully rated
Branch circuit breaker	15–125 A
Branch breaker connector	140 A
Branch circuit breaker types	EGB, EGS and EGH

Description	Rating
Pow-R-Line 3X Ratings	
Voltage	240 Vac, 480 Vac, 600 Vac and 250 Vdc maximum
Main breaker	100–600 A
Main lug	100–800 A
Maximum kAIC	240 Vac: 10–200 kA fully rated 22–200 kA series rated 480 Vac: 14–100 kA fully rated 22–150 kA series rated 600 Vac: 14–65 kA fully rated 25–100 kA series rated 250 Vdc: 10–22 kA fully rated
Branch circuit breaker	15–225 A ^③
Branch breaker connector	225 A
Branch circuit breaker types	BA, QB, QBH, GHQ, GHB, HGHB, Power Defense Frame 2
Pow-R-Line 4X Ratings	
Voltage	240 Vac, 480 Vac, 600 Vac and 250 Vdc maximum
Main breaker	260–1200 A
Main lug	250–1200 A
Maximum kAIC	240 Vac: 10–200 kA fully rated 22–200 kA series rated 480 Vac: 14–100 kA fully rated 22–150 kA series rated 600 Vac: 14–65 kA fully rated 25–100 kA series rated 250 Vdc: 10–22 kA fully rated
Branch circuit breaker	15–1200 A ^④
Branch breaker connector	1200 A
Branch circuit breaker types	BA, QB, QBH, GHQ, GHB, HGHB, Power Defense Frames 2, 3, 4 and 5

Notes

- ① Remote operated circuit breaker.
- ② 600 A is available without main metering.
- ③ PXBCM available for up to 175 A.
- ④ PXBCM available for up to 400 A.

①

Elevator Control Panelboard



Contents

Description	Page
Elevator Control Panelboard	
Product Selection	V2-T3-88
Options	V2-T3-88
Box Sizing and Selection	V2-T3-88

Elevator Control Panelboard

Product Description

- 600 Vac maximum
- Three-phase four-wire
- 800 A maximum mains
- 30–200 A branch devices
- Short-circuit current rating up to 200 kA rms symmetrical
- Elevator controls including shunt trip, CPT, indicating lights and keyed selector switch

Application Description

- Instrument protection
- Fully rated
- Interrupting ratings up to 200 kA symmetrical when protected by fuse
- Provides selective coordination to 0.01 seconds with the appropriate upstream overcurrent protective device
- Eaton’s Elevator Control Panelboard provides significant space savings in the elevator control room when compared to traditional installations
- Factory assembled

Standards and Certifications

- UL 67 panelboards
 - UL 50 enclosures
 - UL 98 fusible switches
- Elevator Control Panelboard is intended to meet the:
- NFPA 70® (National Electrical Code)
 - NFPA 72® (National Fire Alarm Code)
 - ANSI/ASME A17.1 (Safety Code for Elevators and Escalators)
 - NFPA 13® (Installation of Sprinkler Systems)



3.6

Panelboards and Lighting Control

Elevator Control Panelboard

Product Selection

3

Elevator Control Panelboard



Elevator Control Panelboard

Ampere Rating	Interrupting Rating (kA Symmetrical) 600 Vac	Main Type	Fuse Clip ^①
Main Lug Only			
400	200	—	—
600	200	—	—
800	200	—	—
Main Fusible Switch 600 Vac			
400	200	FDPW	Class J
600	200	FDPW	Class J
800	200	FDPB	Class J

Branch Elevator Control Modules ^②

Ampere	Interrupting Rating (kA Symmetrical)	Breaker Type	Fuse Clip ^①
30	200	FDPB	Class J
60	200	FDPB	Class J
100	200	FDPB	Class J
200	200	FDPB	Class J

Options

Elevator Control Options

Description

Fused control power transformer
Fire safety interface relay
ON pilot light
Isolated neutral termination
200% isolated neutral termination
Fire alarm voltage monitoring relay (monitors shunt trip voltage)
NEMA Type 3R enclosure

Surge Protective Devices

120 kA	Basic
	Standard
	Standard with surge counter
160 kA	Basic
	Standard
	Standard with surge counter
200 kA	Basic
	Standard
	Standard with surge counter
250 kA	Basic
	Standard
	Standard with surge counter

Box Sizing and Selection

- Refer to Bid Manager™ drawings for your specific configuration

Notes

- ^① Fuses provided by others.
- ^② Standard features include, fusible switch with 120 Vac shunt trip, control power terminals ground termination, 120 Vac key test switch, 1NO and 1NC 120 Vac class mechanically interlocked auxiliary contact for hydraulic elevators with automatic recall.

Pow-R-Line Xpert Panelboards



Contents

Description

Page

Types PRL1X, 2X, 3E, 3X, 4X, Column Modifications Selection Guide	V2-T3-89
--	-----------------

**Types PRL1X, 2X, 3E, 3X, 4X, Column
Modifications Selection Guide**

Modifications—Alphabetical Index

Modification	Item	Available on Panelboard Types						Column Type	Pow-R-Command
		PRL1X	PRL2X	PRL3E	PRL3X	PRL4X	PRL4F		
Ambient compensating breakers	1	No	No	No	Yes	Yes	—	No	—
Bus density	2	Yes	Yes	Yes	Yes	Yes	Yes	Yes	—
Cabinets—special: Types 2, 3R, 4, 4X, 12	3	Yes	Yes	Yes	Yes	Yes	Yes	No	—
Complete assembly	4	Yes	Yes	Yes	Yes	Yes	Yes	Yes	—
Compression type lugs, mains only	5	Yes	Yes	Yes	Yes	Yes	Yes	Yes	—
Concealed trim clamps (LT trim)	6	Yes	Yes	Yes	Yes	No	No	No	—
Conduit covers	7	Yes	Yes	Yes	Yes	Yes	Yes	No	—
Copper lugs	8	Yes	Yes	Yes	Yes	Yes	Yes	Yes	—
Copper main bus	9, 9a, 9b	Yes	Yes	Yes	Yes	Yes	Yes	Standard	—
Directory frame—metal	10	Yes	Yes	Yes	Yes	Yes	Yes	No	—
Doors, special	11	Yes	Yes	Yes	Yes	Yes	Yes	Yes	—
Fungus-proof	12	Yes	Yes	Yes	Yes	Yes	Yes	Yes	—
Ground bar	13	Yes	Yes	Yes	Yes	Yes	Yes	Yes	—
Electronic trip units	14	No	No	Yes	No	Yes	—	No	—
Ground fault protection (zero sequence)	15	No	No	No	No	Yes	Yes	No	—
Handle lockoff device	16	Yes	Yes	Yes	Yes	Yes	Std.	Yes	—
Hinges, special (LT trim)	17	Yes	Yes	Yes	Yes	Yes	Yes	No	—
Increased dimensions	18	Yes	Yes	Yes	Yes	No	No	No	—
Increased panel bus rating	19	Yes	Yes	Yes	Yes	No	No	No	—
Interiors to fit existing boxes	20	Yes	Yes	Yes	Yes	Yes	Yes	No	—
Locks, special (LT trim)	21	Yes	Yes	Yes	Yes	Yes	Yes	No	—
Molded case switches	22	Yes	Yes	Yes	Yes	Yes	No	Yes	—
Nameplates engraved	23	Yes	Yes	Yes	Yes	Yes	Yes	Yes	—

3.7

Panelboards and Lighting Control

Types PRL1X, 2X, 3E, 3X, 4X and Column Modifications

Modifications—Alphabetical Index, continued

Modification	Item	Available on Panelboard Types						Column Type	Pow-R-Command
		PRL1X	PRL2X	PRL3E	PRL3X	PRL4X	PRL4F		
Neutral rated 200%	24	Yes	Yes	Yes	Yes	Yes	Yes	Yes	Yes
Painting and special coating	25	Yes	Yes	Yes	Yes	Yes	Yes	Yes	Yes
Permanent circuit numbers	26	Yes	Yes	Yes	Yes	Yes	Yes	Yes	Yes
Remote control switches (ASCO 920)	27	No	No	Yes	Yes	No	No	No	No
Service entrance	28	Yes	Yes	Yes	Yes	Yes	Yes	No	Yes
Shunt trips	29	Yes	Yes	Yes	Yes	Yes	Yes	Yes	Yes
Split bus or meter loop	30	No	No	No	Yes	No	No	No	No
Metering devices	31	Yes	Yes	Yes	Yes	Yes	Yes	No	Yes
Sub-metering, Power Xpert	32	No	No	No	No	Yes	No	No	No
Sub-feed breakers	33	Yes	Yes	Yes	Yes	No	No	Yes	Yes
Sub-feed lugs	34	Yes	Yes	Yes	Yes	Yes	Yes	No	Yes
Tamperproof screws (LT trim)	35	Yes	Yes	Yes	Yes	Yes	Yes	Yes	Yes
Through-feed lugs	36	Yes	Yes	Yes	Yes	Yes	Yes	Yes	Yes
Time clock space only	37	Yes	Yes	Yes	Yes	—	—	No	Yes
Touchup paint	38	Yes	Yes	Yes	Yes	Yes	Yes	Yes	Yes
Surge protective device (SPD)	39	Yes	Yes	Yes	Yes	Yes	Yes	No	Yes
Terminals, copper only for breakers	40	Yes	Yes	Yes	Yes	Yes	—	Yes	Yes

1. Ambient Compensating Breakers

For ambient compensating breakers (where available) in lieu of standard breakers, add 10 percent to panelboard branch breaker and to main breaker list prices, if required. (Not UL listed.)

2. Bus Density

Main bus ampere rating is determined by UL listed temperature test. For 750 A per square inch aluminum or 1000 A per square inch copper, make price addition as follows:

Modification 2

Panel Type	Maximum Amperes
Aluminum — 750 A per Square Inch	
PRL1X, 2X	100
	225
	400
PRL3X	250
	400
PRL4X	400
	800
Copper — 1000 A per Square Inch	
PRL1X, 2X	100
	225
	400, 600
PRL3X	250
	600
PRL4X	400
	1200

3. Special Cabinet (Box) Construction

Modification 3

Modification
Type 1 Enclosure
28-inch (711.2 mm) wide in place of standard 20-inch (508.0 mm) wide PRL1X, PRL2X, PRL3E, PRL3X
Type 2 Enclosure
(Drip-proof with gasketed trim) PRL1X, PRL2X, PRL3E, PRL3X 20-inch (508.0 mm) wide
Type 3R Enclosure
PRL1X, PRL2X 20-inch (508.0 mm) wide
PRL1X, PRL2X 28-inch (711.2 mm) wide
PRL3E, PRL3X ① 20-inch (508 mm) wide (600 A maximum)
PRL3E, PRL3X ① 28-inch (711.2 mm) wide (600 A maximum)
PRL4X 24-inch (609.6 mm) or 36-inch (914.4) wide only
Type 12 Enclosure
PRL1X, PRL2X 20-inch (508.0 mm) wide
PRL1X, PRL2X 28-inch (711.2 mm) wide
PRL3E, PRL3X ① 20-inch (508 mm) wide (600 A maximum)
PRL3E, PRL3X ① 28-inch (711.2 mm) wide (600 A maximum)
PRL4X 24-inch (609.6 mm) or 36-inch (914.4) wide only Must also add bus density price from Modification 2 for PRL4X
Type 4 Enclosure or Type 4X Stainless Steel Enclosure
Refer to Eaton

4. Complete Assembly

Complete assembly of panelboard box, interior and trim prior to shipment when required.

5. Compression Main Lugs—Al/Cu Burndy Range-Taking Type

For other terminal types and box sizes, refer to Eaton.

Modification 5—Compression Lug Data

Main Amperes	Wire Range by Panel Type			
	PRL1X and PRL2X	PRL3E	PRL3X	PRL4X
100	(1) #1–1/0 or (1) 2/0–300 kcmil	—	—	—
125	—	(1) #4–2/0 or (1) 2/0–300 kcmil	(1) #4–2/0 or (1) 2/0–300 kcmil	—
225	(1) 2/0–300 kcmil or (1) 4/0–500 kcmil	—	—	—
250	—	(1) 2/0–350 kcmil or (1) 4/0–500 kcmil	(1) 2/0–350 kcmil or (1) 4/0–500 kcmil	(2) 500–750 kcmil
400	(2) 4/0–300 kcmil or (2) 500–750 kcmil	(2) 4/0–300 kcmil or (2) 500–750 kcmil	(2) 4/0–300 kcmil or (2) 500–750 kcmil	(2) 500–750 kcmil
600	—	(2) 2/0–500 kcmil or (2) 500–750 kcmil	(2) 2/0–500 kcmil or (2) 500–750 kcmil	(2) 500–750 kcmil
800	—	—	—	(3) 500–750 kcmil
1200	—	—	—	(4) #2–600 kcmil or (4) 500–750 kcmil

Modification 5—Box Height Additions

Main Amperes	PRL1X, PRL2X	PRL3E, PRL3X without Neutral	PRL3E, PRL3X with Neutral
100	0	0X	0X
225	0	—	—
250	—	2X	5X
400	0	0X	0X
600	0	0X	0X

Maximum size for PRL1X and PRL2X panels: 1–750 kcmil per phase, or 2–500 kcmil per phase. For PRL4X panels, see layout pages.

6. Concealed Trim Clamps—LT Trim

Modification 6

Description
Add per panel PRL1X, PRL2X, PRL3E, PRL3X

7. Conduit Covers

Fabricated sheet metal to cover open conduits above and/or below standard Type 1 box.

Modification 7

Cover Type
Conduit Enclosing Shield (open back) PRL1X, PRL2X, PRL3E, PRL3X, PRL4X—Refer to Eaton
Conduit Enclosure (solid back) PRL1X, PRL2X, PRL3E, PRL3X, PRL4X—Refer to Eaton

Note

① At 600 A, PRL3X requires the addition of density rated copper bus for Type 3R or 12 enclosure.

3.7

Panelboards and Lighting Control

Types PRL1X, 2X, 3E, 3X, 4X and Column Modifications

3

8. Copper Lugs

Optional copper mechanical main lugs only.
(Includes main incoming neutral lug.)

Modification 8

Main Amperes	Wire Range and Number of Lugs Per Phase
100	(1) #14-1/0
225	(1) #6-250 kcmil
250	(1) #6-250 kcmil
400	(2) #1/0-600 kcmil
600	(2) #1/0-600 kcmil
800	(2) #1/0-600 kcmil
1200	(3) #1/0-600 kcmil

Modification 8—Box Height Additions

Main Amperes	PRL1X, PRL2X	PRL3E, PRL3X without Neutral	PRL3E, PRL3X with Neutral	PRL4X
100	0	0X	0X	—
225	0	—	—	—
250	—	0X	0X	0X
400	0	0X	0X	0X
600	—	1X	1X	0X
800	—	—	—	0X
1200	—	—	—	0X

9. Copper Main Bus

Modification 9

Available in PRL1X, PRL2X, PRL3E, PRL3X, PRL4X, PRL1XF, PRL2XF, PRL1RX, PRL2RX, PRL1X-LX and PRL2X-LX

9a. Silver-Plated Copper Main Bus

Modification 9a

Available in PRL1X, PRL2X, PRL3E, PRL3X, PRL4X, PRL1XF, PRL2XF, PRL1RX, PRL2RX, PRL1X-LX and PRL2X-LX

9b. Tin-Plated Copper Main Bus (PRL1X, 2X, 3X, Only)

Modification 9b

Panel Type
PRL1X, PRL2X, PRL3E, PRL3X

10. Directory Frame—Metal

Modification 10

Frame Type
Metal frame, plastic cover

11. Trim and Door Modifications—Special Fronts and Doors

Modification 11

Description
Door-in-door, one door over interior and one which exposes gutter. (LT Trim) (PRL1X, PRL2X, PRL3E, PRL3X only)
Common trim for two section panels with boxes bolted together. (LT Trim) (PRL1X, PRL2X, PRL3E, PRL3X only)
Standard flush lock with quarter turn fasteners at top and bottom of trim door (LT Trim) (standard on doors 48-inch (1219.2 mm) high and over). (PRL1X, PRL2X, PRL3E, PRL3X only)
To provide a trim with a lockable door for PRL4X panels (door-in-door is standard with this adder). Includes National lock with standard keying. ^①
Add per panel

12. Fungus Proofing

For fungus proofing external portions of circuit breakers and all non-metallic parts, add 10 percent of total panelboard list price. For fungus proofing fusible switches and all non-metallic parts, add 20 percent of total panelboard list price.

13. Ground Bar

Modification 13

	Description	Bar Type
Panel Type		
PRL1X PRL2X	Aluminum terminal bar for aluminum or copper cable	Standard, insulated/isolated ^②
PRL3E PRL3X PRL4X	Copper terminal bar for copper cable only	Standard, insulated/isolated ^②
Column Type		
In Pull Box In Gutter	Aluminum terminal bar for aluminum or copper cable	Standard, insulated/isolated ^②
	Copper terminal bar for copper cable only	Standard, insulated/isolated ^②

Notes

- ^① Extra depth box is required. Box will be 12.82-inch (325.6 mm) deep.
- ^② For PRL1X, 2X, 3X and column-type panelboards. The insulated/isolated ground bar includes a standard ground bar.

14. Electronic Trip Units

Modification 14—Applies to Digitrip 310 and 310+ Trip Units

Description

K-, L- and M-Frame Circuit Breaker (three-pole only)
Digitrip RMS310 LS
Digitrip RMS310 LSI
Digitrip RMS310 LSG ①
Digitrip RMS310 LSIG ①
N-Frame circuit breaker
Digitrip RMS310 LS
Digitrip RMS310 LSI
Digitrip RMS310 LSG ①
Digitrip RMS310 LSIG ①
Digiview Ammeter for 310+ Trip Unit

15. Zero Sequence Ground Fault Protection

For main devices only (circuit breakers or FDPW switch) in PRL4X assembled panels. Available in 250–1200 A panels.

Price includes current monitors, ground bar, static sensor, shunt trip, necessary space, mounting and connecting in panelboards. Price does not include circuit breaker or FDPW switch.

Zero sequence ground fault is available with the following family of main devices:

Modification 15

Main Device

JD, KD, LD, MDL, ND, LA-P, NB-P
FDPW switches
(400–1200 A)

16. Circuit Breaker Handle Lockoff Devices

Modification 16

Breaker Types

Non-Padlockable

BAB, QBHW, GHB, PDG2xF, PDG2xG, PDD2xG, PDD2xM, PDD2xP, HQP, QPHW
PDG3xG, PDG4xG

Padlockable

PDG2xF, PDG2xG, PDG2xM, PDG2xP, PDD2xG, PDD2xM, PDD2xP, GHB, BAB, QBHW, HQP, QPHW, EGB, EGS, EGH
PDG3xG, PDG4xG

17. Special Hinges—LT Trim

Piano hinges in lieu of standard hinges.

18. Increased Dimensions (PRL1X, PRL2X, PRL3E and PRL3X Only) Type 1 Enclosure Only

Modification 18

Description

Increased End Gutters

4 inch (101.6 mm) Top or Bottom
7 inch (177.8 mm) Top or Bottom
12 inch (304.8 mm) Top or Bottom

Increased Side Gutters

4 inch (101.6 mm) Left or Right
7 inch (177.8 mm) Left or Right
12 inch (304.8 mm) Left or Right

19. Increased Panel Main Bus Rating (Three-Phase Four-Wire, Single-Phase Three-Wire)

Modification 19

Main Bus Ampere Rating Panel Type

100–225/250	PRL1X, PRL2X, PRL3E, PRL3X
225–400	
600 (PRL3X)	
250–400	PRL4X
400–600	
600–800	
800–1200	

20. Interior and Fronts to Fit Existing Boxes

Contact your local Eaton representative.

21. Special Locks

Modification 21

Description

LT Type Trim

Yale 511S with rosette
Yale 4651S (LL803 Key)
Master keying—above locks or standard lock—per panelboard

Corbin 15767 (Cat. #60 Key)
PRL1X, PRL2X, PRL3E, PRL3X

Tee handle and 3-point catch
PRL1X, PRL2X, PRL3E, PRL3X

COMPX metal lock with standard keying
PRL1X, PRL2X, PRL3E, PRL3X

COMPX metal lock with GE75 keyway
PRL1X, PRL2X, PRL3E, PRL3X, PRL4X

EZ Type Trim

Standard Lock, Keyed GE75
Standard Lock, Keyed to Corbin TEU-1
Standard Lock, Keyed to Corbin Cat 60
Standard Lock, Keyed to Corbin WEM1

Notes

- ① Main breaker only.
- PRL4X with door includes National lock with standard keying. See **Modification 11**.

22. Molded Case Switches (Three-Pole, Two-Pole)**Modification 22****Not UL Listed**

Breaker Frame	Maximum Volts	Maximum Amperes
PDG2xF	480	100
PDG2xG	600	225
PDD3xG	240	400
PDG3xG	600	400
PDG4xG	600	800

23. Nameplates, Engraved**Modification 23****Type**

Mastic back and installed by purchaser, per nameplate

Fixed to panel trim with two screws or rivets, per nameplate
PRL1X, PRL2X, PRL3E, PRL3X only

24. Neutral Rated 200%**Modification 24**

Main Bus Rating	Neutral Rating
100	225
225	450
250	500
400	800
600	1200

Modification 24—Box Height Additions

Main Bus Rating	Neutral Rating	PRL1X, PRL2X	PRL3E, PRL3X	PRL4X
100	225	0	0X	—
225	450	0	—	—
250	500	—	3X	0X
400	800	0	3X	0X
600	1200	—	3X	0X

Note: Dimensions based on mechanical lugs. For compression or copper lugs, refer to Eaton.

For 800 and 1200 A PRL4X with 200% neutral, refer to Eaton.

25. Painting and Special Coatings

Standard boxes are code-gauge galvanized sheet steel. Standard trims are code-gauge sheet steel with a rust inhibiting phosphatized coating and finished with ANSI-61.

Modification 25**Description**

Painted boxes (ANSI-61)

Painted trims or boxes (other than ANSI-61)

26. Permanent Circuit Numbers**Modification 26****Description**

To provide permanently attached Micarta Xcircuit numbers.

27. Remote Control Switches—ASCO 920 (Three-Pole, Two-Pole)

Electrically operated, mechanically held remote control switch directly mounted to panelboard bus for total or split bus switching applications.

(For split bus applications, make price addition from **Modification 30**.)

480 Vac maximum short-circuit rating of panelboard is 22 kAIC maximum.

Includes complete installation in the panelboard with a screw cover over the switch compartment.

Pushbuttons or other control devices are not included. For control circuit modifications, refer to Eaton.

Modification 27—Remote Control Switches (PRL3E and PRL3X Only)**Switch Rating Amperes**

30, 60, 75, 100, 150, 200, 225

Modification 27—Remote Control Switch Modifications**Description**

Two-wire control relay

Three-wire control relay

Control power transformer

To provide hinged cover in place of standard screw cover

28. Service Entrance

To provide a Service Entrance Label as detailed under the "Service Entrance Equipment" in application considerations. Only panelboards meeting these requirements can be labeled as such. The requirement for a Service Entrance Label must be selected at order entry. Service entrance includes neutral disconnect link and Service Entrance Equipment Label. (Ground bar not included—see **Modification 13**.)

Modification 28**Panel Type**

PRL1X, PRL2X, PRL3E, PRL3X, PRL4X

29. Shunt Trip for Main or Branch Circuit Breaker and FDPW Switches

Used for tripping device from a remote point. Voltage and frequency must be specified. Wiring to terminal blocks is not included. Standard leads extend 18-inches (457.2 mm) out of device.

Factory-installed 120, 240 or 480 Vac shunt trips are available with UL listing as shown in table below. Underwriters Laboratories listing is not available for shunt trip mounted on molded case switches.

Modification 29**Device**

BAB, QBHW—Requires one additional pole space, i.e., single-pole is two-pole size, two-pole is three-pole size and three-pole is four-pole size.

GHB (three-pole only)

All other circuit breakers

FDPW switch (400–1200 A)

30. Split Bus or Meter Loop (250 A Max., 3Ph 4W, 3Ph 3W, 1Ph 3W, 1Ph 2W)

Panel type PRL3X only. For enclosure size, refer to Eaton.

Modification 30**Main Bus Amperes**

100–250

31. Metering Devices

Power Xpert digital metering devices for incoming service. Devices are installed in chassis mounted compartment with hinged door. Standard CTs (1200 A maximum) are included with devices. Requires copper bus at 1200 A.

Modification 31**Device** **Box Height Addition**

Device	Box Height Addition
PXM 350 with Pulse Output, Modbus (RS-485), BACnet MSTP	14X ①
PXM 1000 with CTs and display	14X ①
PXM 1000 with CTs, no display	14X ①
PXM 1000 multifunction meter with display	14X ①
PXM 1000 multifunction meter, no display	14X ①
PXM 1100 with CTs and display	14X ①
PXM 1100 with CTs, no display	14X ①
PXM 1100 with data logging and display	14X ①
PXM 1100 with data logging, no display	14X ①
PXM 1200 with CTs and display	14X ①
PXM 1200 with CTs, no display	14X ①
PXM 1200 with data logging, time of use and display	14X ①
PXM 1200 with data logging, time of use, no display	14X ①
PXM 1300 with CTs and display	14X ①
PXM 1300 with CTs, no display	14X ①
PXM 1300 with data logging, waveform capture, PQ logging and display	14X ①
PXM 1300 with data logging, waveform capture, PQ logging, no display	14X ①
PXM 2250 with CTs and display	14X ①
PXM 2250 with CTs, no display	14X ①
PXM 2260 with CTs and display	14X ①
PXM 2260 with CTs, no display	14X ①
PXM 2270 with CTs and display	14X ①
PXM 2270 with CTs, no display	14X ①
PXM 2800 with CTs and display	14X ①
PXM 2800 with CTs, no display	14X ①
PXM 2900 with CTs and display	14X ①
PXM 2900 with CTs, no display	14X ①
PXM 3000 with CTs and display	14X ①
PXM 3000 with CTs, no display	14X ①
PXM 3000 multifunction meter and display	13X ①
PXM 3000 multifunction meter, no display	13X ①

Note

① PRL4X only.

32. Sub-Feed Breakers

Modification 33—Panel Types PRL1X, PRL2X, PRL3E, PRL3X, One Breaker Per Panel

Maximum Amperes	Number of Poles	Breaker Type	Interrupting Rating (kA Symmetrical)		Box Height Addition PRL3X
			240 V	480 V	
100	2	PDG2xF	35	25	NA
225	2	PDG2xG	65	35	NA
225	2	PDG2xM	100	65	NA
225	2	PDG2xP	200	100	NA
225	2	PDD2xF	35	—	NA
225	2	PDD2xG	65	—	NA
225	2	PDD2xM	100	—	NA
400	2	PDD3xG	65	—	15X
400	2	PDG3xG	65	35	15X
400	2	PDG3xM	100	65	15X
400	2	PDG3xP	200	100	15X
100	3	PDG2xF	35	25	NA
225	3	PDG2xG	65	35	NA
225	3	PDG2xM	100	65	NA
225	3	PDG2xP	200	100	NA
225	3	PDD2xF	35	—	NA
225	3	PDD2xG	65	—	14X
225	3	PDD2xM	100	—	14X
400	3	PDD3xG	65	—	15X
400	3	PDG3xG	65	35	15X
400	3	HKD	100	65	15X
400	3	PDG3xP	200	100	15X

Note: 225 A maximum on column-type panelboards. Sub-feed breaker not available on PRL3X panel with subchassis.

33. Sub-Feed Lugs (3Ph 4W, 3Ph 3W, 1Ph 3W, 1Ph 2W)

Note: Not available on service entrance panels with main lugs only (six disconnect rule).

Mechanical Al/Cu lugs. Compression or copper lugs requires additional price adder from **Modification 5—Compression Lug Data** or **Modification 8** as appropriate.

Available on main lug panels only.

Modification 34

Main Amperes	Box Height Addition
Panel Types PRL1X, PRL2X	
100–225	0X
Panel Type PRL3E, PRL3X	
100–250	1X
Panel Type PRL4X ①	
250–400	0X
600	4X

34. Tamperproof Screws—LT Trim

Modification 35

Description

Tamperproof screws for trims, in lieu of standard screws.

35. Through-Feed Lugs (3Ph 4W, 3Ph 3W, 1Ph 3W, 1Ph 2W)

Note: 225 A maximum on column-type panelboards. Not available on service entrance panels with main lugs only (six disconnect rule).

Mechanical Al/Cu lugs. Compression or copper lugs requires additional price adder from **Modification 5—Compression Lug Data** or **Modification 8** as appropriate.

Not available on panels with sub-feed breaker.

Modification 36

Main Amperes	Box Height Addition
Panel Types PRL1X, PRL2X	
100	②
225	②
400	②
600	②
Panel Type PRL3E, PRL3X	
100	2X
250	5X
400	8X
600	8X
800	14X
Panel Type PRL4X ②	
250	7X
400	7X
600	7X
800	7X
1200	5X

36. Time Clock Space Only

Includes box, trim, door and mounting pan.

Modification 37

Enclosure Type

Type 1

PRL1X, PRL2X, PRL3E, PRL3X (24-inch (609.6 mm) space)

PRL1X, PRL2X, PRL3E, PRL3X (36-inch (914.4mm) space)

Type 3R

PRL1X, PRL2X, PRL3E, PRL3X (24-inch (609.6 mm) space)

37. Touchup Paint

Modification 38

Description

12 oz. spray can. ANSI-61 light gray indoor

Case Lot of 12—12 oz. spray cans. ANSI-61 light gray indoor single style

Notes

① Refer to PRL4X layout.

② Refer to panelboard sizing charts.

38. Surge Protective Device (SPD)

Type PRL1X, PRL2X, PRL3E and PRL3X Panelboards

Package includes SPD unit connected to the panelboard bus.

Available for all enclosure types.

Sizing:

PRL1X, PRL2X, PRL3E: Add 7 inches (177.8 mm) to the standard box height.

PRL3X: Add 4X for 100–200 kA SPD units.

Type PRL4X and Elevator Control Panelboards

Package includes SPD unit and integral circuit breaker disconnect (30 A) connected to the panel bus.

Available for all enclosure types.

The SPD unit and integral circuit breaker disconnect will require 7X of chassis space. (Only available in 36-inches (914.4 mm) or 44-inches (1117.6 mm) wide enclosure.)

Modification 39

Description	kA/Phase								
	50	80	100	120	160	200	250	300	400
SPD Package Options									
Basic									
LEDs monitor L-N, L-G, L-L and N-G									
PRL1X, PRL2X, PRL3E, PRL3X	■	■	■	■	■	■	—	—	—
PRL4X, Elevator Control Panelboard	■	■	■	■	■	■	■	■	■
Standard									
Basic package plus: EMI/RFI filtering Audible alarm with disable switch Form C relay contact									
PRL1X, PRL2X, PRL3E, PRL3X	■	■	■	■	■	■	—	—	—
PRL4X, Elevator Control Panelboard	■	■	■	■	■	■	■	■	■
Standard w/Surge Counter									
Standard package plus: Six digit LCD display Counts surges in all modes Non-volatile memory (no battery backup) Reset button designed to prevent accidental resets									
PRL1X, PRL2X, PRL3E, PRL3X	■	■	■	■	■	■	—	—	—
PRL4X, Elevator Control Panelboard	■	■	■	■	■	■	■	■	■
Power Xpert SPD									
Standard w/Surge Counter package plus: Percentage protection status Surge event categorization RJ45 communications Programmable settings									
PRL1X, PRL2X, PRL3E, PRL3X	■	■	■	■	■	■	—	—	—
PRL4X, Elevator Control Panelboard	■	■	■	■	■	■	■	■	■

39. Copper Wire Only Terminals for Molded Case Circuit Breakers

(To replace standard Al/Cu terminals.)

Modification 40

Breaker Frame	Maximum Breaker Ampere Rating	Terminal Material	Wire Range
PD2	225	Copper	#4–4/0
PD3	400	Copper	(1) 250–500, (2) 3/0–250
	600	Copper	(2) 250–500
PD4	600	Copper	(2) #2/0–500
	800	Copper	(3) #3/0–300
PD5	1000	Copper	(3) #3/0–500
	1200	Copper	(4) #3/0–400

Note

① Requires 15 A branch breaker for cable connection—three-pole (three-phase) or two-pole (single-phase). (Add breaker separately, not included in price.)

Pow-R-Command Panelboards



Product Overview

Pow-R-Command™ is a lighting control and energy management system that integrates branch circuit protection, control (switching and dimming) and metering into a single panelboard enclosure. The integrated design simplifies electrical distribution and control systems design, and eliminates separate equipment enclosures and associated wiring. Other benefits include reducing equipment wall space, installation labor and total installed cost. Pow-R-Command systems are designed to meet or exceed ASHRAE, IECC and LEED requirements.

Pow-R-Command Intelligent Panelboards use Eaton Pow-R-Line 1X and 2X lighting panelboard platforms to mount Pow-R-Command electronics and solenoid-operated controllable circuit breakers. Panelboard mains include 100 A to 400 A main lug and main circuit breaker configurations. Available voltages include 120/240, 208Y/120 and 480Y/277, single-phase and three-phase.

Panelboard options include installation of controllable and non-controllable circuit breakers, 200% rated neutral, metering and surge protective devices (SPDs).

Pow-R-Command intelligent lighting control panelboards are assembled in two basic configurations, Pow-R-Command Main and Expansion Panelboard. Pow-R-Command Main Panelboards are designed for standalone and networked systems. Main Panelboard components include controller with low-voltage power supply, Breaker Control Bus (BCB) and solenoid-operated controllable circuit breakers. Expansion Panelboards (PRCEP) are designed to directly connect to Main Panelboard via controller SLAN communications. Expansion Panelboard includes BCB and solenoid-operated controllable circuit breakers. Pow-R-Command systems are scalable using both Main and Expansion Panelboards to provide the right amount of control with reduced installed cost.

Contents

Description

	Page
Features	V2-T3-100
Product Selection	V2-T3-102
Accessories	V2-T3-113



System Electronics

The 5th generation PRC “E” Series controller family includes PRC2000E and PRC750E models. Specifiers and users select the controller to meet specific control and communication requirements. PRC-E controllers offer a broad range of schedule and occupant-based control. Network options include RS-485 and Ethernet. PRC-E controllers communicate with each other using powerful Pow-R-Command peer-to-peer protocol. All PRC-E controllers can be programmed, monitored and overridden using the onboard web pages through the controller maintenance Ethernet port using an industry standard patch cable. The PRC2000E model includes access to onboard web pages through the Ethernet network connector. PRC2000E model includes BACnet/IP and Modbus TCP/RTU for simple and straightforward integration with building management systems. All Pow-R-Command controllers can control up to 168 solenoid-operated controllable circuit breakers by connecting PRCEP panelboards using the controller SLAN sub-network communications port.

BCB electronics come in 9-, 15- and 21-circuit lengths depending on the size of the panelboard and are directly mounted to panelboard interior rails. BCBs are connected to the controller SLAN via 4-conductor cable and act as the interface between controller and controllable circuit breaker for providing status and control. Onboard power switching circuitry signals the controllable circuit breaker solenoid to switch the controllable circuit breaker ON and OFF. Each BCB is addressable between 1 and 8, allowing the controller to monitor and control up to 168 controllable circuit breakers. Pow-R-Command panelboards are assembled with one or two BCBs to offer the right amount of control.

Controllable Circuit Breakers

Controllable circuit breakers include standard circuit protection and control. Solenoid mechanism provides control, mechanical and electronic status and override lever. Controllable circuit breakers are available in 15–30 A, single-pole and two-pole configurations and are suitable for electrical distribution systems up to 480Y/277 Vac. Emergency lighting controllable circuit breakers are two-pole devices used for controlling dual purpose emergency lighting fixtures. Device includes non-switched pole to maintain power on the battery power sensing circuit and the second pole is controllable to switch the load ON and OFF.

Accessories

Pow-R-Command system accessories include override switches, analog I/O expansion module, switch override controller, main building lighting controller and communications devices.

Software

PRCE series controllers include an embedded web server. PRC systems are configured, programmed and monitored via a commonly used web browser and mobile devices. PRC Lighting Optimization Software (PRCLOS) is only recommended for remote connection to existing legacy PRC100 and PRC1000 systems. Consult factory for more information.

Features

Pow-R-Command Main Panelboard Mounted Components

3

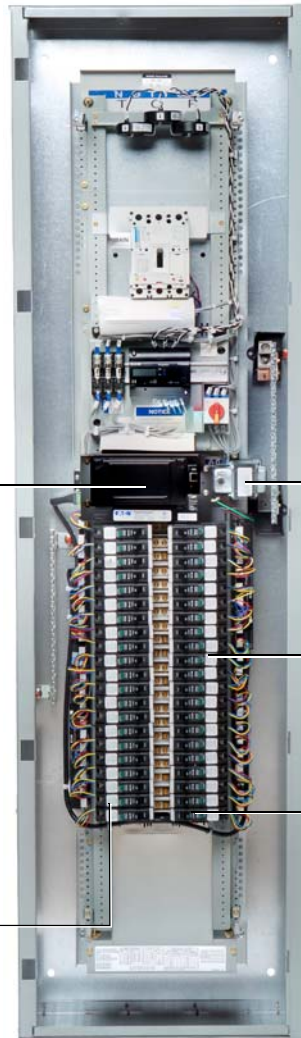

PRC-E panelboard system is controlled and monitored by microprocessor-based controller. Onboard time clock provides schedule-based control. Digital inputs are used for connecting low-voltage wallstations and occupancy sensors for override control. Analog I/O used for dimming and daylight harvesting control. Light level sensors are connected to analog inputs. Both fluorescent and LED lighting fixtures equipped with 0–10 Vdc dimming circuitry are connected to controller analog outputs. PRC-E controllers include backlit color LCD touchscreen and maintenance port for local programming, system monitoring and override control. User can locally access controller by connecting PC to controller front panel maintenance port using industry standard patch cable. Ethernet and RS-485 network connections located in controller low-voltage compartment provide remote access options.

Standard circuit breakers can be mounted to feed non-controlled loads.

Low-voltage regulated power supply provides stable power for system electronics and reliable switching of solenoid-operated controllable circuit breakers.

Breaker Control Bus (BCB) electronics provide the control and monitoring interface between Pow-R-Command controllers and solenoid-operated controllable circuit breakers.

Single- and multi-pole solenoid-operated controllable circuit breakers provide branch circuit protection and control of connected loads.

Pow-R-Command Expansion Panelboard

Expansion Panelboard (PRCEP) includes Breaker Control Bus electronics and solenoid-operated controllable circuit breakers. Main and Expansion Panelboards are connected via SLAN communications sub-network to provide a scalable system architecture for cost-effective control solutions.

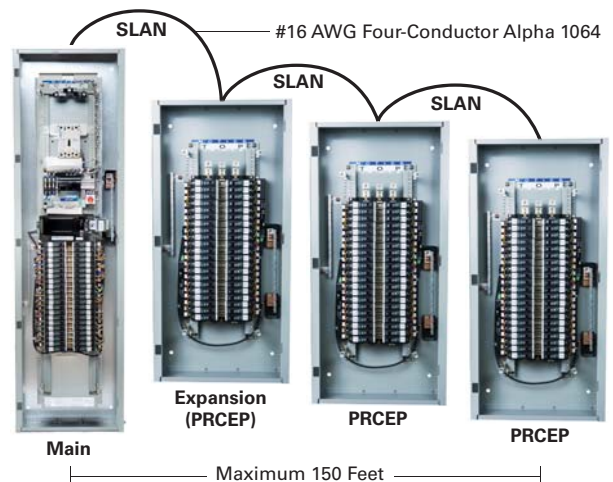

Consult factory for applications requiring longer distances.

Pow-R-Command Controllers

Pow-R-Command intelligent lighting control panelboards integrate branch circuit protection and control into a single panelboard enclosure to eliminate the need for mounting external time clocks with contactors or relay panels. Two 5th generation PRC-E series controller models are available to allow users and specifiers to select the controller that best fits the application.

PRC750E

- Microprocessor-based programmable lighting control system intended for standalone applications
- Designed with the electrical contractor in mind, it offers integral back-lit color LCD touchscreen display for simple, straightforward commissioning and startup
- Front panelboard programming can also be achieved by connecting the controller maintenance port to a laptop using an industry standard Ethernet patch cable
- Preconfigured web pages can be used to program, monitor and override the system
- Control options include schedule-based, occupant override and photocell control
- Sixteen two-wire low-voltage inputs are available for connecting wall stations, occupancy sensors and photocells
- Each controller can be connected to three Expansion Panelboards via SLAN communications to control and monitor up to 168 solenoid-operated circuit breakers

PRC2000E

- Ethernet communications
- BACnet/IP and Modbus TCP/RTU communications protocol for integrating into building management systems
- Remote access to preconfigured web pages for programming, system monitoring and override control via Ethernet network connection
- Up to 120 controllers can be connected to the same Pow-R-Command RS-485 peer-to-peer network
- Powerful peer-to-peer protocol and network architecture allows schedules and external wiring device signals to be broadcast over the network to control any or all of the solenoid-operated controllable circuit breakers connected to the system. This system capability eliminates the need for changing the same schedule in multiple panelboards and requiring additional wiring devices to be directly connected to specific controllers
- Eight universal inputs can be programmed to accept either digital or analog external wiring devices. Compatible with low-voltage digital wiring devices like wall stations, occupancy sensors and photocells when programmed as digital inputs. When programmed as 0–10 Vdc analog inputs, indoor and outdoor photosensors can be connected for dimming and daylight harvesting applications
- Eight analog 0–10 Vdc outputs for connecting to fluorescent and LED lighting fixtures equipped with 0–10 Vdc dimming circuitry to meet dimming and daylight harvesting application requirements
- Compatible with existing PRC2000 and PRC100 systems

Product Selection

PRC-E Controller

Pow-R-Command “E” Series controllers are available in two models and offer a range of features to meet a broad range of applications and meet energy codes.

Each PRC-E controller includes a backlit color LCD touchscreen, SLAN expansion network, schedule-based controls and two-wire low-voltage inputs for connecting occupancy sensors, wallstations and other building control signals.

The PRC-E Controller Selection Guide may be used to quickly identify the controller that best fits the application.

PRC-E Controller Selection Guide

Controller	PRCEP	PRC750E	PRC2000E
Inputs			
Dry-contact inputs	—	16	8
Universal inputs, configurable dry-contact or analog 0–10 Vdc	—	—	8
Outputs			
Maximum number of controllable circuit breakers	—	168	168
Analog outputs, 0–10 Vdc, 80 mA sink or 40 mA source current ^①	—	—	8
Power supply to power external devices, 100 mA at 12 Vdc/30 Vac	—	■	■
Power supply to power integrated Breaker Control Bus and SLAN V+ and V–	PRCEPP	■	■
Inputs and Outputs Accessory Modules			
Analog Expansion Module (PRCEAEM) w/ 8 universal inputs configurable as maintained dry-contact or analog 0–10 Vdc, 8 analog outputs 0–10 Vdc at 80 mA sink or source current ^{①②③}	—	—	8 UI/8 AO
Switch Override Controller (PRCSOC) w/ 60 maintained dry-contact inputs, optional card includes 32 two-wire 24 Vdc outputs for status LEDs ^④	—	—	60 I/ 32 O
Control Logic			
Panelboard configurations include 18, 30, 42, 60, 72 and 84 circuits	—	■	■
Maximum number of control groups, 17–250 groups require PRCLCS software configuration	—	16	250
365-day time clock	—	■	■
Astronomical time clock with sunrise and sunset offsets	—	■	■
Schedules	—	250	250
Holidays	—	32	32
Automatic daylight savings time	—	■	■
Circuit breaker blink notice	—	■	■
Override time switches	—	■	■
Manual dimming and automatic daylight harvesting	—	—	■
Configurable source logic (OR, AND, XOR, XNOR, NAND and LAST EVENT)	—	—	■

Notes

- ① Refer to driver/ballast manufacturer specs to calculate maximum connected load.
- ② Connects to controller MLAN network.
- ③ Maximum of seven PRCEAEM connected to MLAN network.
- ④ Connects to controller RS-485 CNET network.

PRC-E Controller Selection Guide, continued



3

Controller	PRCEP	PRC750E	PRC2000E
Communications			
Expansion panelboard SLAN	■	■	■
Maximum Breaker Control Bus (BCB) per SLAN	—	8	8
Ethernet network	—	—	■
BACnet/IP protocol	—	—	■
Modbus TCP/RTU	—	—	■
Email notification, user configurable alarms	—	—	■
Pow-R-Command RS-485 (CNET)	—	—	■
Digital Switch Network (DSN)	—	—	■
MLAN communications to Analog Expansion Module (PRCEAEM) ①	—	—	■
MLAN communications to metering devices with Modbus RTU communications ②	—	—	■
Modbus TCP pass-through metering mode	—	—	■
Modbus RTU, Breaker Control Bus addresses 1–16	■	—	—
Local Programming			
4.3-inch backlit color LCD touchscreen	—	■	■
Front maintenance port (Ethernet) access to web server ③	—	■	■
PRC Lighting Optimization Software (PRCLOS), maintenance port (Ethernet) access ③	—	■	■
Password protection	—	■	■
Remote Programming			
Remote access to controller web server via Ethernet connection	—	—	■
PRC Lighting Optimization Software (PRCLOS)	—	—	—
Password protection	—	■	—
Memory			
SD card for logs and programming database (GB)	—	4	4
Onboard capacitor to power clock chip during power outage (days)	—	10	10

Notes

- ① Maximum of seven PRCEAEM connected to MLAN network.
- ② Maximum of eight meters with Modbus RTU communications.
- ③ Requires industry standard Ethernet patch cable.

3.8

Panelboards and Lighting Control

Pow-R-Command

3

Externally Mounted Controllers

Externally mounted controllers (PRCEEC) are available for retrofit and renovation projects when existing panelboards do not have required controller mounting space. Externally mounted controllers include controller and control power transformer mounted in a NEMA 1 enclosure.

Eaton Pow-R-Line 1X and 2X lighting panelboards can be converted to Pow-R-Command Expansion Panelboards (PRCEP) in the field by mounting Breaker Control Bus (BCB) and controllable circuit breakers directly to the interior.

Externally mounted controllers are connected to the retrofitted PRCEP panelboard using the SLAN communications network.

PRCE Externally Mounted Controller



PRCE Externally Mounted Controllers

Controller Type	Connected System Voltage	Catalog Number
PRC750E with display	120 Vac	PRC750EECD-120
PRC750E with display	277 Vac	PRC750EECD-277
PRC2000E with display	120 Vac	PRC2000EECD-120
PRC2000E with display	277 Vac	PRC2000EECD-277

Breaker Control Bus

Breaker Control Bus (BCB) provides the electronic interface and power switching signal between the controller and solenoid-operated controllable circuit breaker.

BCB comes in three lengths to fit standard lighting panelboards and is mounted to the panelboard interior rails. Each BCB has a set of DIP switches to configure the device SLAN address

between 1 and 8. BCBs are connected to the PRC-E controller using PRC-to-BCB and BCB-to-BCB SLAN cables in a daisy-chain network architecture. RUN, SLAN and PWR LEDs indicate BCB operating status.

Breaker Control Bus (BCB)



Breaker Control Bus (BCB)

Description	Controlled Circuits	Part Number	Catalog Number ^①
9-circuit Breaker Control Bus	9	1A32374G13	PRCBCB9R
18-circuit Breaker Control Bus	18	1A32374G12	PRCBCB15R
21-circuit Breaker Control Bus	21	1A32374G11	PRCBCB21R

Note

^① Includes mounting screws and remote-operated circuit breaker pigtail connector protective caps.

Controller and Breaker Control Bus SLAN Cables

Controller and BCB SLAN cables are used for connecting controllers to associated BCBs.

Each cable type is made in three lengths using Alpha 1064 4-conductor #16 AWG wire.

One pair of wires used for 30 Vac power with the second pair used to transmit and receive communications from connected controller.

Controller and Breaker Control Bus SLAN Cables



Controller and Breaker Control Bus SLAN Cables

Description	Catalog Number
Controller-to-BCB / 42-circuit	PRCSLAN42
Controller-to-BCB / 30-circuit	PRCSLAN30
Controller-to-BCB / 18-circuit	PRCSLAN18
Controller-to-BCB / 42-circuit with right BCB only	PRCSLAN42R
Controller-to-BCB / 30-circuit with right BCB only	PRCSLAN30R
Controller-to-BCB / 18-circuit with right BCB only	PRCSLAN18R
BCB-to-BCB / 42-circuit	PRCSLAN42B
BCB-to-BCB / 30-circuit	PRCSLAN30B
BCB-to-BCB / 18-circuit	PRCSLAN18B

Auxiliary Power Supply

Auxiliary Power Supply (PRCPS) is used to boost power on the SLAN. Main and Expansion Panelboards communicate over the SLAN via Alpha 1064 4-conductor #16 AWG cable. Recommended maximum SLAN length is 150 ft. One pair of wires provides power to BCB for switching controllable circuit

breakers with the second pair used for controller to BCB RS-485 communications. The PRCPS can be used to power a single Expansion Panelboard or extend the SLAN an additional 150 ft. The SLAN can be extended up to 4000 ft by using a PRCPS in each PRCEP.

Auxiliary Power Supply





Auxiliary Power Supply



Description	Catalog Number
PRC power supply 96 VA with 120/277 Vac input and 30 Vac output voltage	PRCPS

Controllable Circuit Breakers

GHQRD ①

	Number of Poles	Ampere Rating	Interrupting Capacity (Symmetrical Amperes) Vac (50/60 Hz)				Catalog Number
			120	120/240	277	277/480	
Single-Pole 	1	15	65,000	65,000	14,000	—	GHQRD1015
		20	65,000	65,000	14,000	—	GHQRD1020
		30	65,000	65,000	14,000	—	GHQRD1030
Two-Pole 	2	15	65,000	65,000	—	14,000	GHQRD2015
		20	65,000	65,000	—	14,000	GHQRD2020
		30	65,000	65,000	—	14,000	GHQRD2030



GHQRSP ②

	Number of Poles	Ampere Rating	Interrupting Capacity (Symmetrical Amperes) Vac (50/60 Hz)				Catalog Number
			120	120/240	277	277/480	
Single-Pole 	1	15	65,000	65,000	14,000	—	GHQRSP1015
		20	65,000	65,000	14,000	—	GHQRSP1020
		30	65,000	65,000	14,000	—	GHQRSP1030
Two-Pole 	2	15	65,000	65,000	—	14,000	GHQRSP2015
		20	65,000	65,000	—	14,000	GHQRSP2020
		30	65,000	65,000	—	14,000	GHQRSP2030



Notes

- ① Not recommended for existing PRC25, PRC100, PRC750 and PRC2000 systems. GHQRSP controllable circuit breakers are compatible with these systems.
- ② Compatible with existing PRC25, PRC100, PRC750(E), PRC1500(E) and PRC2000(E) systems. Recommend using GHQRD controllable circuit breakers for PRC-E systems.

BABRSP ①

Number of Poles	Ampere Rating	Interrupting Capacity (Symmetrical Amperes) Vac (50/60 Hz)		Catalog Number
		120	120/240	
Single-Pole 	15	10,000	—	BABRSP1015
	20	10,000	—	BABRSP1020
	30	10,000	—	BABRSP1030
Two-Pole 	15	—	10,000	BABRSP2015
	20	—	10,000	BABRSP2020
	30	—	10,000	BABRSP2030
	40	—	10,000	BABRSP2040
	50	—	10,000	BABRSP2050

BABRP ②

Number of Poles	Ampere Rating	Interrupting Capacity (Symmetrical Amperes) Vac (50/60 Hz)		Catalog Number
		120	120/240	
Single-Pole 	15	10,000	----	BABRP1015
	20	10,000	----	BABRP1020
	30	10,000	----	BABRP1030
Two-Pole 	15	----	10,000	BABRP2015
	20	----	10,000	BABRP2020
	30	----	10,000	BABRP2030
	40	----	10,000	BABRP2040

Notes

- ① Compatible with PRC25, PRC100, PRC750(E) and PRC2000(E) systems. Recommend using BABRP controllable circuit breakers for PRC25 systems.
- ② Compatible with PRC25, MTM6 and MTM4 controllers only. Not compatible with PRC750(E) and PRC2000(E) systems.

Emergency Circuit Breaker

The GHQRDEL and GHQRSPEL controllable circuit breakers are designed to meet NEC 700.12(F) for sources of power in unit equipment used for emergency lighting applications. The controllable circuit breaker includes both

switched circuit for controlling lighting and standard non-switched circuit to provide power to the unit emergency charging and detection circuitry. Controllable circuit breaker includes a common handle tie and a common trip mechanism.

Emergency Circuit Breaker



GHQRD Emergency Circuit Breaker ①

Number of Poles	Ampere Rating	Interrupting Capacity (Symmetrical Amperes) Vac (50/60 Hz)		Catalog Number
		277	277/480	
2	15	14,000	—	GHQRDEL2015
	20	14,000	—	GHQRDEL2020

Emergency Circuit Breaker



GHQRSP Emergency Circuit Breaker ②

Number of Poles	Ampere Rating	Interrupting Capacity (Symmetrical Amperes) Vac (50/60 Hz)		Catalog Number
		277	277/480	
2	15	14,000	—	GHQRSPEL2015
	20	14,000	—	GHQRSPEL2020

Notes

- ① Compatible with PRC750E, PRC1500E and PRC2000E systems. Not recommended for existing PRC100, PRC750 and PRC2000 systems. GHQRSPEL controllable circuit breakers are compatible with these systems.
- ② Compatible with PRC750(E), PRC1500(E) and PRC2000(E) systems. Not recommended for existing PRC100, PRC750 and PRC2000 systems. GHQRSP controllable circuit breakers are compatible with these systems.

Pow-R-Command Switches

Digital Switches

Pow-R-Command Digital Switches (PRCDS) are used for occupant override and light level control. PRCDS include digital and analog I/O and 12 Vdc external power source for connecting field wiring devices. The 12 Vdc external power source is used to power an occupancy sensor and digital input for monitoring occupancy status. Analog input is used to connect a light level sensor analog output for controlling lighting equipped with 0–10 Vdc dimming circuitry. Consult factory for maximum number lighting fixtures. Digital switches are connected to controllers' Digital Switch Network (DSN) via CAT6 cable with 23 AWG wire using standard RJ45 connectors. Each controller DSN supports connecting up to 99 digital switches. Onboard rotary switches allow addresses to be set in the field. LED backlit buttons provide real-time breakers and/or groups status. Each digital switch can have a title description using up to 16 characters. Pushbutton labels can have up to four characters. Standard font type is Helvetica regular bold.

Front View



Back View



Six-Button



Six-Button Engraved



Digital Switches ①②

Color	Number of Buttons	Catalog Number
Black	2	PRCDS2B
	4	PRCDS4B
	6	PRCDS6B
White	2	PRCDS2W
	4	PRCDS4W
	6	PRCDS6W
Almond	2	PRCDS2A
	4	PRCDS4A
	6	PRCDS6A
Ivory	2	PRCDS2V
	4	PRCDS4V
	6	PRCDS6V

Notes

- ① Not compatible with PRC750(E) controllers. Recommended for PRC2000(E) controllers.
- ② Contact factory for custom labeling.

3.8

Panelboards and Lighting Control

Pow-R-Command

Digital Switch I/O Configuration

Pushbutton Configuration	Analog Input 0–10 Vdc	Digital Input 0–10 Vdc	Analog Output 0–10 Vdc	12 Vdc Output 20 mA Maximum
Two-button	■	■	■	■
Four-button	■	■	■	■
Six-button	■	—	■	■

Digital Switch Network Splitter

Digital Switch Network Splitter (PRCDSNS) is used as a convenient way to split the DSN into 2 legs to span in two directions.

If there are more than 50 Digital Switches connected to a controller, a splitter is recommended.

Consult factory for applications that may require this device.

Digital Switch Network Splitter



Digital Switch Network Splitter

Description	Catalog Number
Digital Switch Network Splitter	PRCDSNS

Digital Switch Network Power Injector

Digital Switch Network Power Injector (PRCDSNPI) is used to provide 24 Vac power on the DSN. A PRCDSNPI should be installed on the

DSN before every 16th PRCDS or before the total length of DSN reaches 500 ft (whichever comes first).

Digital Switch Network Power Injector



Digital Switch Network Power Injector

Description	Catalog Number
Digital Switch Network Power Injector	PRCDSNPI

Low-Voltage Switch

Pow-R-Command Low-voltage Switch (PRCLS) includes momentary dry-contact pushbuttons used for inputs into the controller. PRCLS directly connect to controller digital and universal inputs.

Each PRCLS can have a title description using up to 16 characters. Pushbutton labels can have up to four characters. Standard font type is Helvetica regular bold.

Low-Voltage Switch



Termination Board



Low-Voltage Switch ①

Color	Number of Buttons	Catalog Number
Black	2	PRCLS2B
	4	PRCLS4B
	6	PRCLS6B
White	2	PRCLS2W
	4	PRCLS4W
	6	PRCLS6W
Almond	2	PRCLS2A
	4	PRCLS4A
	6	PRCLS6A
Ivory	2	PRCLS2V
	4	PRCLS4V
	6	PRCLS6V

Switch Wallplates

Fits rocker-style Decorator, Decora style switches. Screwless design is available in black, white, almond and ivory for 1-, 2- and 3-switch designs.

Switch Wallplates



Switch Wallplates

Color	Number of Switches	Catalog Number
Black	1	PRCSWP1B
	2	PRCSWP2B
	3	PRCSWP3B
White	1	PRCSWP1W
	2	PRCSWP2W
	3	PRCSWP3W
Almond	1	PRCSWP1A
	2	PRCSWP2A
	3	PRCSWP3A
Ivory	1	PRCSWP1V
	2	PRCSWP2V
	3	PRCSWP3V

Note

① Consult factory for custom labeling.

Analog Expansion Module

PRCE Analog Expansion Module (PRCEAEM) is used when the required number of analog inputs or analog outputs exceeds the PRCE main controller's maximum number of eight. Each PRCEAEM includes eight universal inputs and eight 0–10 Vdc analog outputs. Universal inputs are used to connect 0–10 Vdc analog devices, such as photosensors. Universal inputs can also accept 2-wire maintained dry-contact devices.

Analog outputs are used to connect LED and fluorescent lighting equipped with 0–10 Vdc dimming control circuitry. There is a maximum of 80 mA sink or source current per analog output channel. The PRCEAEM is shipped in a factory assembled NEMA 1 enclosure with 120 Vac voltage power supply.

It can be mounted near the controller or remotely to reduce field wiring. Up to a maximum of seven PRCEAEMs can be connected to PRC2000E controllers. Maximum overall network length of 4000 ft. PRCEAEM is configured using the PRC2000E controller web server interface.

PRCEAEM is connected to the PRCE controller MLAN network in a daisy-chain network architecture using Belden 3105A shielded twisted pair cable.

PRCEAEM Specification

- Eight universal inputs
 - Used to connect 0–10 Vdc analog photosensors or 2-wire maintained dry-contact devices
 - 18 AWG 500 ft maximum distance
- Eight analog outputs
 - Used to connect lighting fixtures equipped with 0–10 Vdc dimming circuitry
 - Maximum 80 mA sink or source current
 - 18 AWG 1000 ft maximum distance
- MLAN RS-485 network
 - Belden 3105A shielded twisted pair in a daisy-chain network architecture
 - 4000 ft maximum overall network length from PRCE controller
- Compatible with PRC2000E (maximum of seven devices)
- Configured by using PRC2000E embedded web server
- I/O status and control
 - PRC2000E controller web pages
- Available in NEMA 1 enclosure with 120 Vac power supply (see table below)

PRCEAEM_E



PRCE Analog Expansion Module (PRCEAEM)

Description	Catalog Number
One analog expansion module, NEMA 1 enclosure with 120 Vac power supply	PRCEAEM1E
Two analog expansion modules, NEMA 1 enclosure with 120 Vac power supply	PRCEAEM2E
Three analog expansion modules, NEMA 1 enclosure with 120 Vac power supply	PRCEAEM3E
Four analog expansion modules, NEMA 1 enclosure with 120 Vac power supply	PRCEAEM4E

Note: Consult factory for non-standard configurations and enclosures.

Pow-R-Command Switch Override Controller

The Pow-R-Command Switch Override Controller (PRCSOC) can be used to connect digital and analog I/O to Pow-R-Command systems. This device is recommended when controller onboard digital and analog I/O has been exceeded or when there is an advantage to connecting remote I/O via a network connection. The PRCSOC is supplied with the controller, termination board, dual voltage 120/277 Vac power supply in a NEMA 1 enclosure. Optional 32-status LED output card is available.

The PRCSOC is connected to the Pow-R-Command system via the RS-485 network. Status and command signals are sent to the system using Pow-R-Command peer-to-peer protocol. The PRCSOC is configured using Pow-R-Command Lighting Optimization Software (PRCLOS).

All digital and analog I/O is connected using #18 AWG with maximum of 500 ft length. The PRCSOC features include:

- Sixty low-voltage two-wire maintained switch inputs for connecting wall stations, occupancy sensors and control relay outputs from building management systems
- Eight low-voltage two-wire universal (digital or analog) inputs. Analog field devices like light level sensors with 0–5 Vdc outputs can be connected for dimming and daylight harvesting applications
- Three low-voltage 0–10 Vdc analog outputs for controlling fluorescent and LED light fixtures equipped dimming circuitry; maximum of 40 each per output with optional dimmer cables
- Sixteen low-voltage two-wire 24 Vdc outputs to power status LEDs; optional to add 32 low-voltage two-wire 24 Vdc outputs to power status LEDs
- External 15 Vdc power source for powering occupancy and light level sensors and PRC auxiliary devices
- Connects to Pow-R-Command RS-485 network
- Communicates to the system using Pow-R-Command peer-to-peer protocol
- Configured by using Pow-R-Command Lighting Optimization Software
- Provided in a NEMA 1 enclosure
- Not compatible with PRC750(E) controllers

Pow-R-Command Switch Override Controller



Pow-R-Command Switch Override Controller

Description	Catalog Number
PRC Switch Override Controller without power supply mounted in NEMA 1 enclosure	PRCSOCC
PRC Switch Override Controller w/ 120/277 Vac power supply mounted in a NEMA 1 enclosure	PRCSOCEC
PRC Switch Override Controller w/ 120/277 Vac power supply, pilot output card mounted in a NEMA 1 enclosure	PRCSOCECO

Accessories

Ethernet Interface Module

Pow-R-Command Ethernet Interface Module (PRCEIM) allows access to the PRC controller RS-485 network when using a PC connected directly to the EIM Ethernet port or connected on a facility’s Ethernet network.

PRCEIM can be used as the main scheduler and includes 250 unique schedules. The PRCEIM can be programmed to sync controller time clocks. This device is connected to the Ethernet network using standard CAT5 cable. The three-pin connector is used to directly connect to the Pow-R-Command RS-485 controller network.

The PRCEIM comes in a table top enclosure and should be physically located near an Ethernet hub or repeater, but the PC can be located anywhere on the Ethernet network. The PRCEIM will communicate at 10BASE-T and must have a fixed IP address assignment on the Ethernet network.

Ethernet Interface Module



Ethernet Interface Module ⓘ

Description	Catalog Number
PRC Ethernet Interface Module mounted in table top enclosure	PRCEIM

Note

ⓘ Not compatible with PRC750(E) controllers. Recommended for PRC100 controllers.

BACnet Interface Module

Pow-R-Command BACnet Interface Module (PRCBIM-1) is designed for simple BACnet integration without the need for extensive BACnet knowledge. The device maps Pow-R-Command controller points to BACnet/IP points of any RS-485 network connected Pow-R-Command controller. The PRCBIM-1 can map up to 50 points.

These points include status and control of individual controllable circuit breakers and groups of controllable circuit breakers. Input status is also included in the points map. Programming the device is accomplished by using Pow-R-Command Lighting Optimization Software (PRCLOS). The PRCBIM-1 includes two network connections.

The RS-485 connection is used for connecting the Pow-R-Command RS-485 network while the Ethernet 10BASE-T connection is used for connecting to the facility Ethernet network. The device requires a fixed IP address to be configured before connecting to the network.

BACnet Interface Module



BACnet Interface Module ①

Description	Catalog Number
PRC BACnet Interface Module	PRCBIM-1

BACnet Shadow Server

Pow-R-Command BACnet Shadow Server (PRCSS) is designed for simple BACnet integration without the need for extensive BACnet knowledge. The PRCSS maps Pow-R-Command controller points to BACnet/IP points. Up to 120 devices can be connected to a system. Each PRCSS has full access to all 150 points of the directly connected Pow-R-Command controller. These points include status and control of individual controllable circuit breakers and groups of controllable circuit breakers.

Input status is also included in the points map. Programming the device is accomplished by using Pow-R-Command Lighting Optimization Software (PRCLOS). The PRCSS includes two network connections. The RS-485 connection is used for connecting the Pow-R-Command RS-485 network while the Ethernet 10BASE-T connection is used for connecting to the facility Ethernet network.

The PRCBIM-1 includes two network connections. The RS-485 connection is used for connecting the Pow-R-Command controller while the Ethernet 10BASE-T connection is used for connecting to the facility Ethernet network. The device requires a fixed IP address to be configured before connecting to the network. Device power is supplied by controller 12 Vdc external power source.

BACnet Shadow Server



BACnet Shadow Server ①

Description	Catalog Number
PRC BACnet Shadow Server	PRCSS

Note

① Not compatible with PRC750(E) controllers. Recommended for PRC100 controllers.

Universal Ethernet Interface

The Pow-R-Command Universal Ethernet Interface (PRCUEI) is used in conjunction with the PRC5000(E) Advanced Lighting Controller to connect multiple RS-485 networks using the facility’s Ethernet network via TCP protocol.

The PRC5000(E) can connect up to 16 Pow-R-Command RS-485 networks using a PRCUEI to connect each network. The PRCUEI supports up to 120 Pow-R-Command devices on each RS-485 network.

The device power is supplied by the controller 12 Vdc external power connection.

PC Central Software (PRCPCC01) is required for configuration and programming.

Universal Ethernet Interface



Universal Ethernet Interface ①

Description	Catalog Number
PRC Universal Ethernet Interface	PRCUEI

Universal Ethernet Router

Universal Ethernet Router PRCUER is intended for facilities where an Ethernet network is already installed.

The PRCUER extends the Pow-R-Command controller network by tunneling Pow-R-Command controller LAN control packets over existing Ethernet network using UDP Ethernet protocol. PRCUER devices extend the controller

LAN transparently across Ethernet segments within the same subnet, allowing segments of the controller network to be physically separated from each other within a facility. Programming the device is accomplished by using Pow-R-Command Lighting Optimization Software (PRCLOS). The PRCUER includes two network connections.

The RS-485 connection is used for connecting the Pow-R-Command RS-485 network while the Ethernet 10BASE-T connection is used for connecting to the facility Ethernet network. The device can be configured for DHCP or be assigned a static IP address. Device power is supplied by controller 12 Vdc external power source.

Universal Ethernet Router



Universal Ethernet Router ①

Description	Catalog Number
PRC Universal Ethernet Router	PRCUER

Note

① Not compatible with PRC750(E) controllers. Recommended for PRC100 controllers RS-485 networks.

Pow-R-Command

3

PRC5000E Main Controller

Pow-R-Command 5000E Main Controller (PRC5000E) is capable of providing main scheduling control, load shedding and demand response, reporting, trend logging and implementing other control strategies.

PRC5000E Main Controller is commonly used to serve facility custom graphics via web pages. Authorized users can log into the device using a standard web browser for viewing custom graphics. System schedule changes and override controls can be made at the click of a button.

PRC5000E



PRC5000E Main Controller

Description	Catalog Number
Small Building Controller (web graphics) up to 20 CNET devices in enclosure	PRC5000ESE
Small Building Controller (web graphics) up to 20 CNET devices with I/O (7DO, 4AO, 4DI, 8UI) in enclosure	PRC5000ESIE
Small Building Controller (web graphics) up to 20 CNET devices with BACnet/IP in enclosure	PRC5000ESBE
Small Building Controller (web graphics) up to 20 CNET devices with I/O (7DO, 4AO, 4DI, 8UI) with BACnet/IP in enclosure	PRC5000ESIBE
Building Controller (web graphics) more than 20 CNET devices in enclosure	PRC5000EE
Building Controller (web graphics) more than 20 CNET devices with I/O (7DO, 4AO, 4DI, 8UI) in enclosure	PRC5000EIE
Building Controller (web graphics) more than 20 CNET devices with BACnet/IP in enclosure	PRC5000EBE
Building Controller (web graphics) more than 20 CNET devices with I/O (7DO, 4AO, 4DI, 8UI) with BACnet/IP in enclosure	PRC5000EIBE

Suffix	Feature
S	Small Building less than 20 devices
B	BACnet/IP
I	I/O (7DO, 4AO, 4DI, 8UI)
E	Enclosure

PRC25 Controller

PRC25 controller and associated system components are available for repair and replacement.

Direct replacement for existing MTM-4 and MTM-6 controllers. Consult factory for more information.

PRC25



PRC25 Controller

Description	Catalog Number
PRC25 6-channel controller	PRC25

Lighting Optimization Software

Lighting Optimization Software (PRCLOS) is recommended for Pow-R-Command system users. Refer to Software Compatibility Chart.

PRCLOS allows users to set up, program and monitor their system. This basic software package is capable of recognizing and saving databases for a single site.

Software Compatibility Chart ^①

Controller Model	Compatibility
PRC100	Yes
PRCSOC (Switch Override Controller)	Yes
PRCNIB (Network Interface Box)	Yes
PRCEIM (Ethernet Interface Module)	Yes
PRC750 ^②	Yes
PRC2000 ^③	Yes
PRC750E ^{④⑤}	Up to and including firmware version 5.2.0
PRC2000E ^{⑤⑥}	Up to and including firmware version 5.2.0

Lighting Optimization Software

Description	Catalog Number
PRC Lighting Optimization Software	PRCLOS

PC Central Software

PC Central Software (PRCPCC) is recommended for field technicians responsible for maintaining Pow-R-Command systems. Refer to Software Compatibility Chart.

PRCPCC allows users to set up, program and monitor their system with the added features of advanced diagnostics and programming capabilities. This advanced software package is capable of recognizing and saving databases for single or multiple sites.

PC Central Software

Description	Catalog Number
PC Central Software (single site)	PRCPCC01
PC Central Software (10 sites)	PRCPCC10

Desktop Computer

Recommended Minimum Computer Specifications

Although it is difficult to guarantee compatibility with all PC-compatible equipment, the basic installation is generally compatible with the following minimum specifications:

- Microsoft® Windows® operating system
- Intel i3 processor or equivalent
- 4 GB RAM
- 1024x768 or better display
- Ethernet network adapter
- USB port if connecting to legacy products
- Windows Server 2008 R2, all 32- and 64-bit versions
- Windows 7, all 32- and 64-bit versions
- Windows 8.1, all 32- and 64-bit versions
- Windows Server 2012, 64-bit
- Windows 10, 64-bit

Lighting Optimization Software and PC Central Software is compatible with the following Microsoft operating systems:

Smart Cable Programming Tool

Pow-R-Command Smart Cable (PRCSmartCable) is used for front panelboard programming PRC100, PRC750 and PRC2000 controllers.

The PRCSmartCable connects the local laptop USB port to controller maintenance port.

Smart Cable Programming Tool

Description	Catalog Number
PRC smart cable	PRCSmartCable

Notes

- ① Contact Pow-R-Command Tech Support for more information. 833-POW-R-CMD.
- ② Local access only through maintenance port. PC connection requires PRCSmartCable.
- ③ Optional local access through maintenance port. PC connection requires PRCSmartCable.
- ④ Local access only through maintenance port. PC connection requires industry standard patch cable.
- ⑤ Firmware version 7.1.0 and above not compatible with software. Controller configuration, programming, monitoring and override performed using commonly standard web browsers.
- ⑥ Optional local access through maintenance port. PC connection requires industry standard patch cable.

Metering Service Section

3



Product Description

- 600 Vac maximum
- Three-phase four-wire, three-phase three-wire, single-phase three-wire.
- Service entrance panel combining a main disconnect with a power company metering compartment
- Circuit breaker or fusible switch disconnect
- 400–1200 A ratings
- Provision for power company metering:
 - Hinged sealable door over CT section
 - Arranged for bar-type, 200–1200 A utility-furnished CTs
 - Barried CT compartment
- Factory assembled
- Wallmounted enclosure

Application Description

- For use in areas where the disconnect and current transformer combination is required by utilities
- Suitable for use as Service Entrance Equipment
- Top or bottom entrance
- Hot or cold sequence metering
- The current transformer compartment will accommodate the following 12-inch (304.8 mm) bar-type CTs:

Bar-Type CTs

	General		
ABB	Electric	Sangamo	Astra
CTB	JCT-10	R6B	TAB, TA
CSF	JCM-0	R6BA	TCB, AA
CMF	JCW-0	R6M	AB
CBH	JAK-0		

Contents

Description

Page

Metering Service Sections	
Catalog Number Selection	V2-T3-119
Product Selection	V2-T3-119
Technical Data and Specifications	V2-T3-120
Dimensions	V2-T3-120

Standards and Certifications

- UL 67, UL 50
- NEC



Catalog Number Selection

Panelboard Catalog Number Selection Guide ①

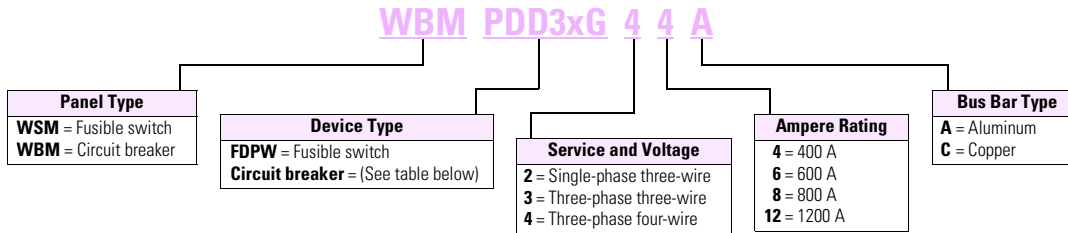

Example: WBMPDD3xG44A

WBM = Circuit breaker type, PDD3xG = Circuit breaker type from table below, 4 = Three-phase four-wire, 4 = 400 A, A = Aluminum bus bar.

Product Selection

Metering Service Section



Type WBM Circuit Breaker Sections

Max. Ampere Rating	Interrupting Rating (kA Symmetrical)			Breaker Type ②③	Base Catalog Number ④
	240 Vac	480 Vac	600 Vac		
400	65	—	—	PDD3xG	WBMKD
400	65	35	25	PDG3xG	WBMKD
400	100	65	35	PDG3xM	WBMHMDL
400	200	100	65	PDG3xP	WBMKDC
800	65	35	25	PDG4xG	WBMMDL
800	100	65	35	PDG4xM	WBMHMDL
800	100	65	35	PDG5xM	WBMHND800
1200	65	50	25	NDG ⑤	WBMNDG1200
1200	100	65	35	PDG5xM	WBMHND1200
1200	100	65	35	HNDG ⑤	WBMHNDG1200

Notes

- ① Refer to Hartford Satellite Plant.
- ② For other breaker types, refer to Hartford Satellite Plant.
- ③ In cold sequence metering only, a 10X or 18X feeder breaker section can be supplied downstream from the CT compartment. Refer to Hartford Satellite Plant.
- ④ Complete catalog number according to Catalog the Number Selection Guide—table above.
- ⑤ Integral ground fault.

WSM Fusible Switch Sections

Ampere Rating	Interrupting Rating (kA Symmetrical)	Fusible Switch ^①	Base Catalog Number ^②
240 Vac Fusible Devices ^③			
400	Refer to table on right (FDPW Switch Ratings, 250 or 600 Vac)	FDPW	WSMFDPW
600		FDPW	WSMFDPW
800		FDPW	WSMFDPW
1200		FDPW	WSMFDPW
600 Vac Fusible Devices ^③			
400	Refer to table on right (FDPW Switch Ratings, 250 or 600 Vac)	FDPW	WSMFDPW
600		FDPW	WSMFDPW
800		FDPW	WSMFDPW
1200		FDPW	WSMFDPW

Modifications

Modifications for WBM Metering Service Sections

Description

Copper bus
Circuit breaker shunt trip installed
Circuit breaker undervoltage release installed
Type 3R outdoor enclosure
Provisions for PTs

Modifications for WSM Metering Service Sections

Description

Copper bus
Shunt trip installed
Type 3R outdoor enclosure
Provisions for PTs
FDPW fusible switch ground fault system Includes zero sequence current monitor, static sensor, shunt trip and fused control power transformer

Technical Data and Specifications

FDPW Switch Ratings, 250 or 600 Vac

Ampere Rating	Fuse Class Used ^①	Short-Circuit Ratings (kA Sym.)
400, 600	R	200
400, 600	J ^③	200
800, 1200	L	200

Dimensions

Approximate Dimensions in Inches (mm)

Note: Not to be used for construction purposes unless approved.

Type 1 Enclosure—Metering Service Section

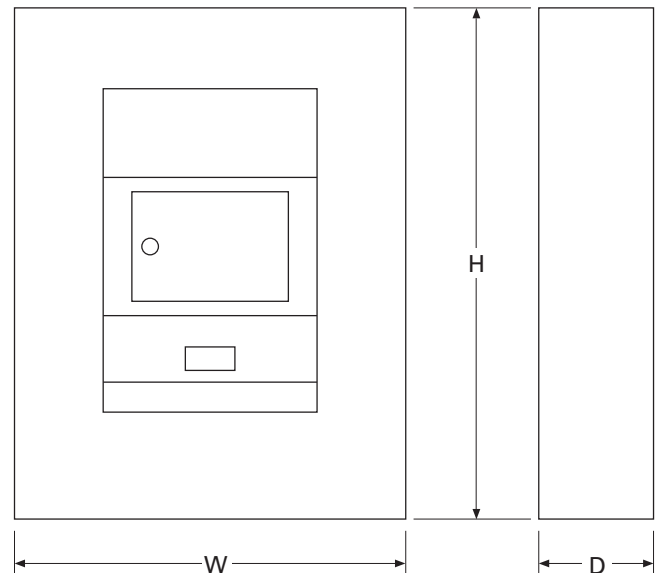

Type 1 Enclosure

Panelboard Type	Ampere Rating	Enclosure Dimensions			Box Catalog Number
		Height	Width	Depth	
WBM, Circuit breaker	400–1200	73.50 (1866.9)	36.00 (914.4)	11.31 (287.0)	BX3673
WSM, Fusible	400–1200	90.50 (2286.0)	36.00 (914.4)	11.31 (287.0)	BX3690

Notes

- ① Fuses are not included.
- ② Complete catalog number according to Catalog Number Selection Guide—**Page V2-T3-119**.
- ③ Class J Fuse provisions are applicable only to 600 V units. When required, use price and dimensions of 600 V units for all voltages 600 and below.

Pow-R-Xpress

Program Description

Pow-R-Xpress is Eaton's enhanced stocking program focused on supporting light commercial projects and small jobs through the distributor's stock.



Type PRL1X Panelboard

The Pow-R-Xpress program gives distributors greater control over inventory levels, costs and pricing while enabling their customers to complete small projects, easier and faster—ensuring repeat business.

The Product Offering

Pow-R-Xpress PRL1X and PRL2X panels are available as unassembled (interiors, main breakers/lugs, boxes and trims) from distributor stock.

- 120/240 V, 208Y/120 V and 480Y/277 V ratings
- 100–600 A mains
- Single- and three-phase
- Surface and flush mounted
- Aluminum or copper bus
- Type 1 or Type 3R enclosures
- Service entrance available
- Options for 200% neutrals and isolated ground bars
- Full menu of branch breakers available

Benefit from the Pow-R-Xpress Stocking Program

Eaton's Pow-R-Xpress program enables distributors to increase productivity, differentiate from competition and provide superior customer service through their stock. Distributors maintain a competitive advantage by leveraging greater control over stock and pricing. The program will help provide a higher level of engagement through branding/marketing materials, product training, local expertise/knowledge and above all, stock.

How Contractors Benefit from the Pow-R-Xpress Stocking Program

When contractors work with a trusted Pow-R-Xpress distributor, they get reliable, on-time access to the Eaton products they need. Trained experts will assist them every step of the way, from understanding application needs to helping select the right products, while offering tips for quick and easy installation. Contractors will also get access to Eaton's custom product solutions for unique project applications.

Contractors will be able to:

- Respond to quick-turn opportunities
- Get what they need at the job site
- Receive specification changes and corrections
- Fulfill last-minute requests to complete the job
- Partner with experts who are trained on the products and applications

- Access configurators and tools to select the right product for the job
- Connect with manufacturer experts, operations, etc.
- Get proper assembly matching with color-coordinated labels



Pow-R-Xpress Program Includes the EZ Trim and EZ Box

Unassembled Panelboard Option



Pow-R-Line 1X and 2X Panelboards are Designed to Provide Application Flexibility with Off-the-Shelf Service

The Pow-R-Xpress unassembled panelboard interior is designed specifically for distributor stock and field assembly. Its modular design allows for easy configuration in the field.

Top or bottom incoming, main lugs or main breaker...all with the same Pow-R-Xpress unassembled interior. Lug and breaker kits provide greater flexibility with fewer boxes, interiors and trims to stock.

Color-Coded Package Labels

The box, interior and trim packaging are clearly identified with brightly colored labels (a different color for each box size). This facilitates stocking, filling orders, and matching components in the field.

Contact your local Eaton distributor for more details on the Pow-R-Xpress unassembled panelboard option.

Eaton Distributors

Contact your Eaton sales distributor specialist representative or regional marketing manager and arrange to review the program details and criteria for qualification as a Pow-R-Xpress distributor.

Satellites

A unique concept of facilities close to customer locations, assuring fast delivery of standard- and custom-assembled equipment when it's needed.

Located at strategic locations throughout the United States, these facilities manufacture and deliver standard or custom-assembled panelboards, switchboards and enclosed circuit breakers...when and where you need them. And, when you have an emergency, they can have your equipment ready in hours.

Highly trained and experienced personnel will manage your order and ensure that you receive on-time delivery of high quality equipment that meets your specifications.

Special Configurations

The unique capabilities of these plants and people can provide solutions for special products to meet special needs.

Typical examples include special dimensions, retrofit equipment and panelboard interiors to fit existing boxes.

Speedy Delivery

Consult your local sales engineer or Satellite facility for expedited lead-time quotations.

Save Time and Money

No matter your location, you will save time and money when ordering from a Satellite location. For more information, contact your Eaton representative or authorized distributor.

Satellite Operations

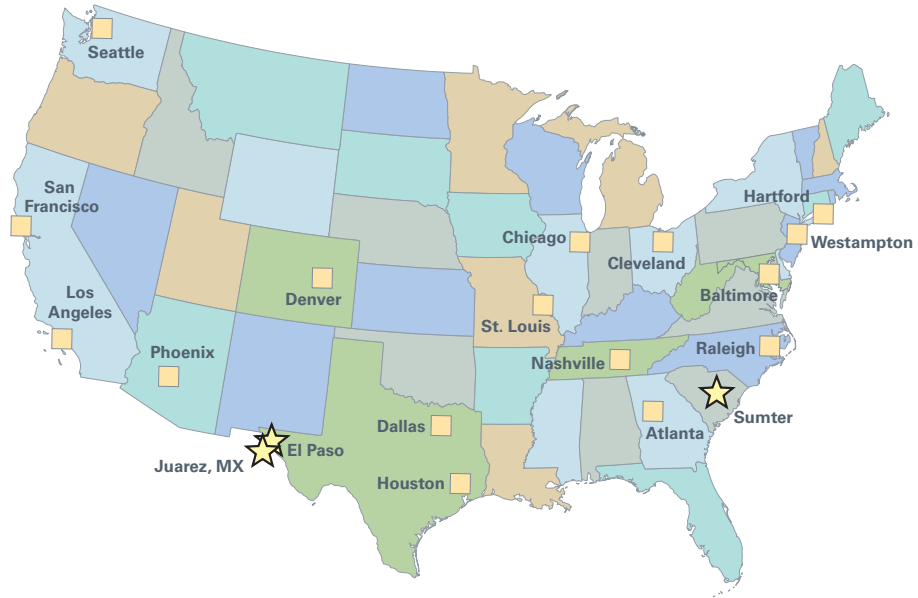

Eaton Pow-R-Line panelboards and switchboards are built to your requirements at our world-class manufacturing plants in Sumter, SC, El Paso, TX, and Juarez, MX. In addition, Eaton has 16 regional Satellite facilities located across the country to meet your panelboard and switchboard service needs.

Atlanta

7000 Highlands Parkway SE
Suite 102
Smryna, GA 30082
678.309.4260

Baltimore

7451 Coca Cola Drive
Suite C
Hanover, MD 21076
410.796.7777

Chicago

230 Windy Point Drive
Glendale Heights, IL 60139
630.260.6303

Cleveland

12875 Corporate Drive
Unit E
Parma, OH 44130
216.265.3284

Dallas

631 Westport Parkway
Suite 100
Grapevine, TX 76051
817.251.6733

Denver

2450 Airport Road
Suite C
Aurora, CO 80011
303.366.2080

El Paso

45 Butterfield Circle
Suite C
El Paso, TX 79906
915.881.0259

Hartford

40A International Drive
Windsor, CT 06095
860.298.1305

Houston

14825 Northwest Freeway
Suite 100
Houston, TX 77040
713.744.7530

Juarez

Prolongacion Hermanos
Escobar #7014,
Parque Industrial Omega
Adicion Oriental Cd.
Juarez, Chihuahua
Mexico 32648

Los Angeles

13201 Dahlia Street
Suite 300
Fontana, CA 92337
919.428.8903

Nashville

1421 Gould Boulevard
Suite C
La Vergne, TN 37086
615.287.3200

Phoenix

560 N 54th Street
Suite 1
Chandler, AZ 85226
480.449.4222

Raleigh

9400 Globe Center Drive
Suite 121
Morrisville, NC 27560
919.544.7074

St. Louis

56 Soccer Park Road
Fenton, MO 63026
636.717.3500

San Francisco

20923 Cabot Boulevard
Hayward, CA 94545
510.784.8981

Seattle

1604 15th Street SW
Suite 114
Auburn, WA 98001
253.833.5021

Sumter

Main Manufacturing Plant
845 Corporate Circle
Sumter, SC 29154
803.481.3131

Westampton

96 Stemmers Lane
Westampton, NJ 08060
609.835.4230