

**OVERALL DIMENSIONS**

ENCOUBREMENT

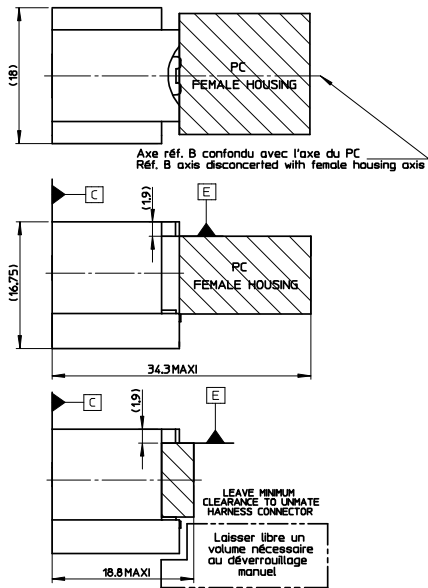

**VARIANT PINS LOCATION**

VARIANTE IMPLANTATION LANGUETTES

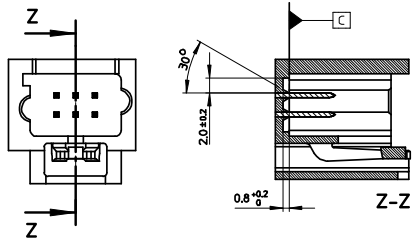

**PINS POSITION**

POSITION DES LANGUETTES

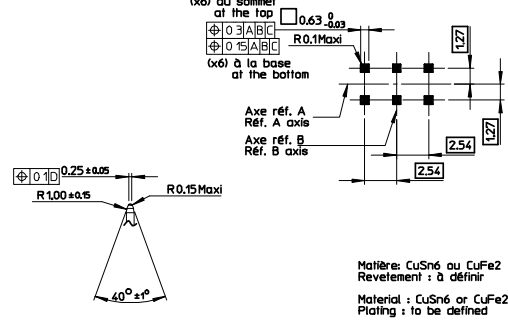

**CODINGS / DETROMPAGES**

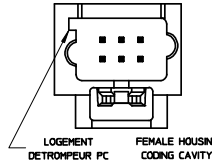

BLACK NOIR

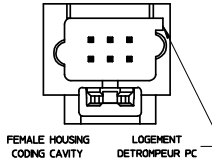

BROWN MARRON

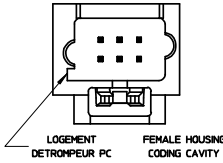

BLUE BLEU

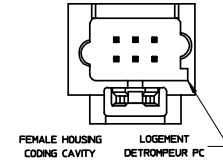

GREY GRIS

**BLACK CODING SHOWN**

DETROMPAGE NOIR REPRESENTE

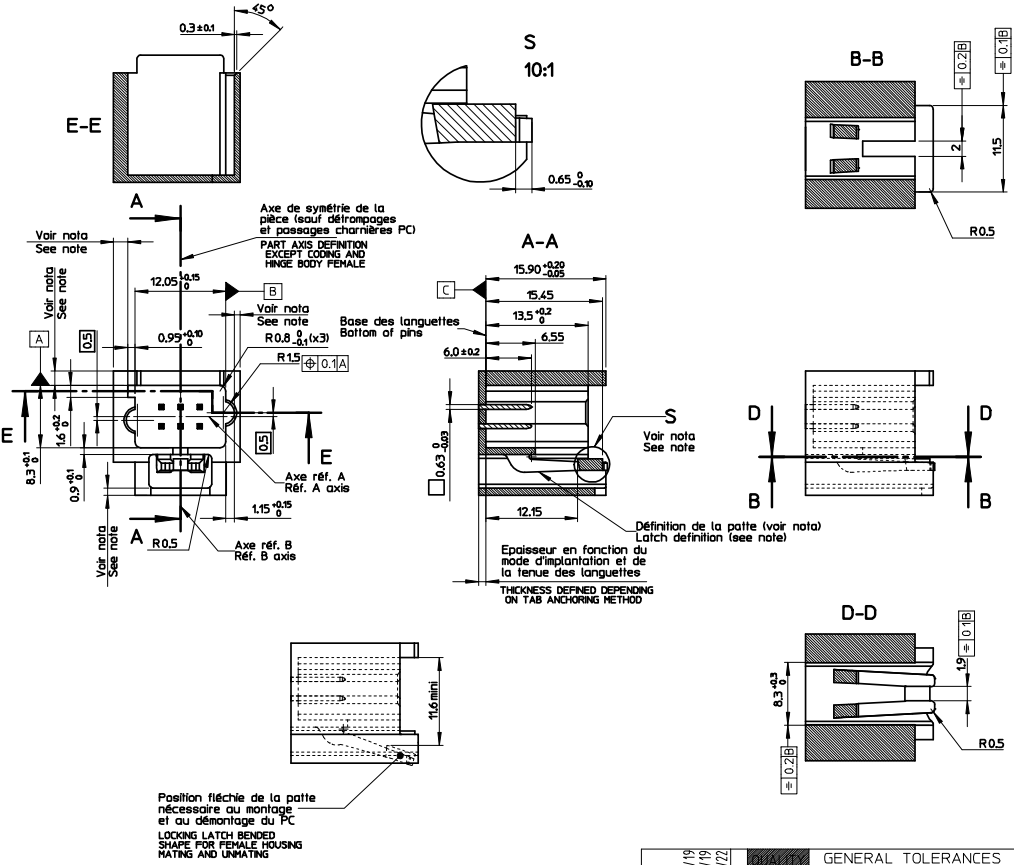

**MODIFICATIONS**

REV.	DESCRIPTIONS	NAME	DATE
A	X-RELEASED	PBO	07/03/15
B	SQUARE PINS: 0.63 0/-0.03 WAS 0.63 0/-0.30.	PGR	07/06/01
B1	SEE SHEET 2/2	VG	08/06/28

**NOTA :**  
1 - COTATION ET GEOMETRIE A DEFINIR EN FONCTION DE LA MATIERE (VOIR PLANCHE 2)

**NOTE :**  
1 - DIMENSIONS AND GEOMETRY TO BE DEFINED ACCORDING MATERIAL (SEE SHEET 2)

<b>REVIEW NOTE</b> EC NO: GZ2008-0509 DRAWN BY: DRIVANGIERIN CHKD: JUDUCLOS APPR: LSTICKEIR 2008/08/19 2008/08/19 2008/08/22	<b>QUALITY SYMBOLS</b> 	GENERAL TOLERANCES (UNLESS SPECIFIED)		DIMENSION STYLE <b>MM ONLY</b>		SCALE 3:1	DESIGN UNITS METRIC	FIRST ANGLE PROJECTION	
		4 PLACES ± --- ± --- 3 PLACES ± --- ± --- 2 PLACES ± --- ± --- 1 PLACE ± 0.1 ± ---	mm INCH	DRAWN BY PBOQUAIN	DATE 2007/03/15	TITLE <b>6 CKT INTERFACE FEMALE HOUSING</b>			
		ANGULAR ± 1°		CHECKED BY JUDUCLOS	DATE 2007/03/15	APPROVED BY LSTICKEIR			
		DRAFT WHERE APPLICABLE MUST REMAIN WITHIN DIMENSIONS		MATERIAL NO. N/A	DATE 2007/03/15	Molex <b>MOLEX INCORPORATED</b>		DOCUMENT NO. SD-98787-001	SHEET NO. 1 OF 2



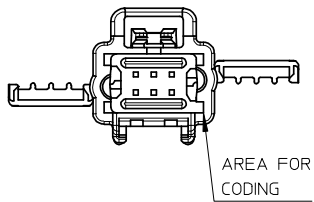

AREA FOR CODING

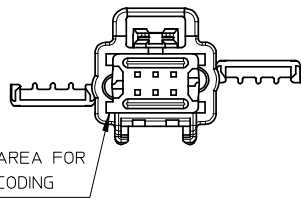

AREA FOR CODING

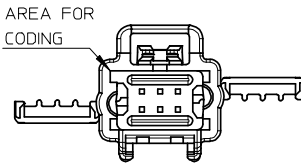

AREA FOR CODING

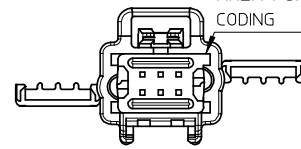

AREA FOR CODING

MATERIAL NUMBER	0987871011	MATERIAL NUMBER	0987871019	MATERIAL NUMBER	0987871018	MATERIAL NUMBER	0987871016
COLOR	BLACK	COLOR	BROWN	COLOR	GREY	COLOR	BLUE

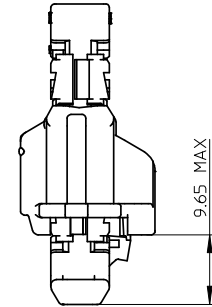
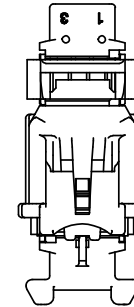
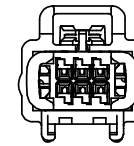

NECESSARY VOLUME FOR THE HOUSING ASSEMBLY.  
ALLOW AN ADDITIONAL VOLUME FOR THE UNMATING

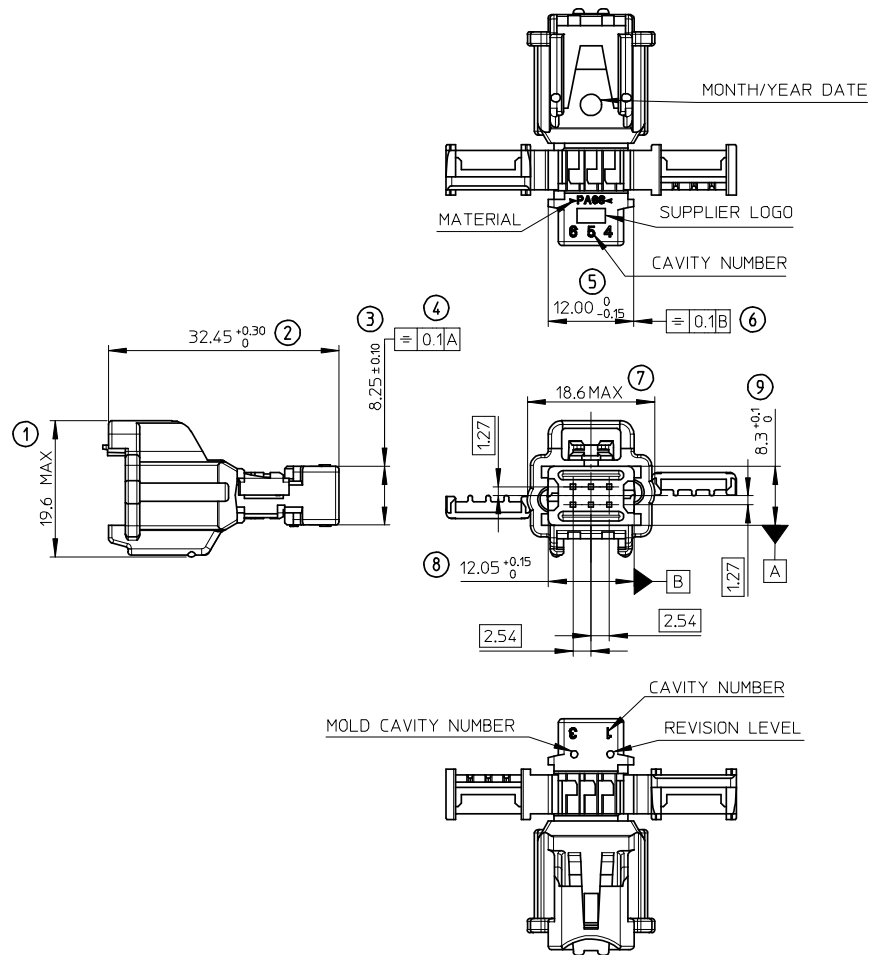

- NOTES :
- 1-MATERIAL : POLYAMIDE (PA66) UNFILLED , UL94V-2
  - 2-USE WITH : MQS ® PIN TERMINAL OR COMPATIBLE
  - 3-APPLICATION SPECIFICATION : AS-98787-001
  - 4-MATE WITH : SERIES 98786
  - 5-WEIGHT : 2.150 g

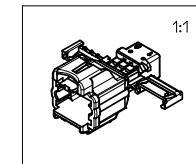

<b>FIRST RELEASE</b> EC NO: G2008-0366 DRAWN: VGUERIN 2008/03/25 CHKD: JLDUCLOS 2008/03/25 APPR: LSTICKEIR 2008/03/27	DESCRIPTION [REDACTED]	GENERAL TOLERANCES (UNLESS SPECIFIED)		DIMENSION STYLE <b>MM ONLY</b>	SCALE <b>2:1</b>	DESIGN UNITS <b>METRIC</b>	THIRD ANGLE PROJECTION	
		4 PLACES ± --- ± ---	mm INCH	DRAWN BY VGUERIN	DATE 2008/03/14	TITLE <b>MOX PIN HSG 0.635 6CKT</b>		
		3 PLACES ± --- ± ---		CHECKED BY JLDUCLOS	DATE 2008/03/14			
		2 PLACES ± 0.05 ± ---		APPROVED BY LSTICKEIR	DATE 2008/03/14			
		1 PLACE ± 0.10 ± ---		MATERIAL NO.		DOCUMENT NO.		SHEET NO.
DRAFT WHERE APPLICABLE MUST REMAIN WITHIN DIMENSIONS		ANGULAR ± 2 °		SEE CHART		MOLEX INCORPORATED <b>SD-98787-002</b>		
				THIS DRAWING CONTAINS INFORMATION THAT IS PROPRIETARY TO MOLEX INCORPORATED AND SHOULD NOT BE USED WITHOUT WRITTEN PERMISSION		1 OF 1		