

6

5

4

3

2

1

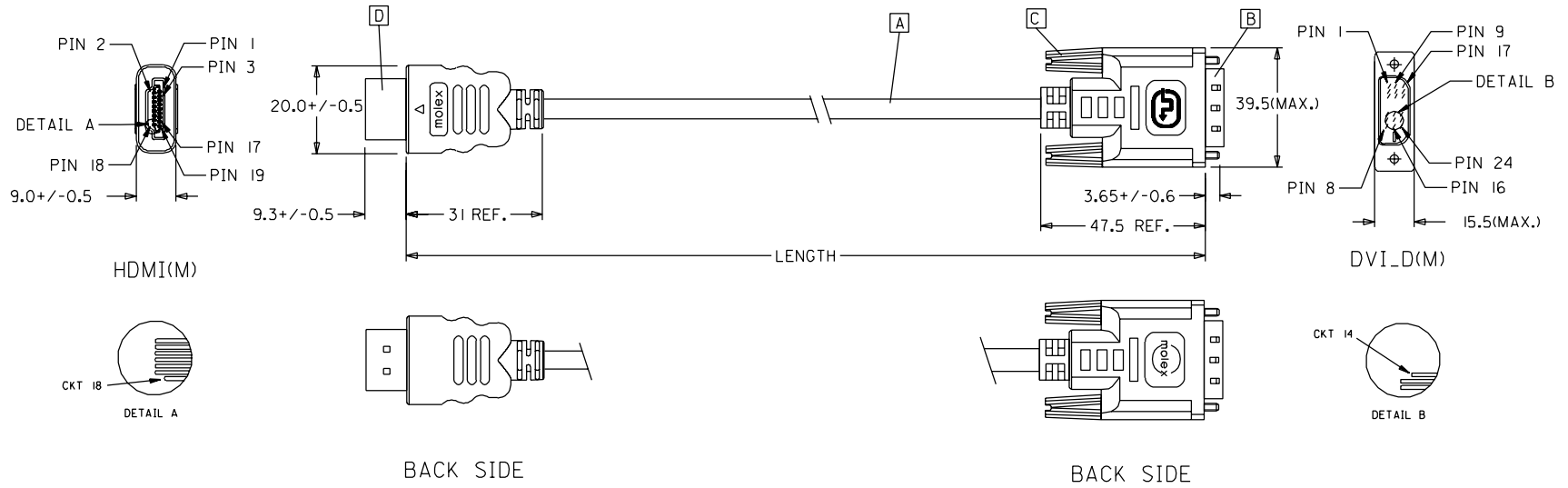

88768-3620	HDMI TO DVI-D(M) CABLE ASS'Y,3M	3000+/-80	BLACK	5,5MM(TMDS - AWG*30)
88768-3610	HDMI TO DVI-D(M) CABLE ASS'Y,2M	2000+/-60	BLACK	5,5MM(TMDS - AWG*30)
88768-3600	HDMI TO DVI-D(M) CABLE ASS'Y,1M	1000+/-30	BLACK	5,5MM(TMDS - AWG*30)
88768-3530	HDMI TO DVI-D(M) CABLE ASS'Y,5M	5000+/-100	BLACK	7,3MM(TMDS - AWG*28)
88768-3520	HDMI TO DVI-D(M) CABLE ASS'Y,3M	3000+/-80	BLACK	7,3MM(TMDS - AWG*28)
88768-3510	HDMI TO DVI-D(M) CABLE ASS'Y,2M	2000+/-60	BLACK	7,3MM(TMDS - AWG*28)
88768-3500	HDMI TO DVI-D(M) CABLE ASS'Y,1M	1000+/-30	BLACK	7,3MM(TMDS - AWG*28)
MX P/N	DESCRIPTION	LENGTH	CABLE COLOR	CABLE OD

EC NO. DRWN: CHK: APPR:	DESCRIPTION	QUALITY SYMBOLS	GENERAL TOLERANCES: (UNLESS SPECIFIED)		SCALE N.S.T	DESIGN UNITS <input checked="" type="checkbox"/> mm <input type="checkbox"/> INCH	THIRD ANGLE PROJECTION	<input type="checkbox"/> mm INCH <input type="checkbox"/> mm <input checked="" type="checkbox"/> mm ONLY	SHT REV
		MAJOR ▼ = 0	4 PLACES ±0. ±.	mm INCH	DRAWN BY & DATE Louis Chen 03/11/17	TITLE: HDMI(M) TO DVI-D(M) CABLE ASS'Y			
		CRITICAL ▽ = 0	3 PLACES ±0. ±.		CHECKED BY & DATE Teddy Kan 03/11/17	MOLEX INCORPORATED			
			2 PLACES ±0. ±.		APPROVED BY & DATE Baron Chen 03/11/17				
		1 PLACE ±0. ±.	ANGULAR: ± °	CAD FILENAME S88768AA.SOI	MATERIAL NO. SEE TABLE	DRAWING NO. SD-88768-001	SHEET NO. 1 OF 2		
C	REV	THIS DRAWING CONTAINS INFORMATION THAT IS PROPRIETARY TO MOLEX INCORPORATED AND SHOULD NOT BE USED WITHOUT WRITTEN PERMISSION.							SIZE A4

6

5

4

3

2

1

NOTE: 1. OVERMOLD SPECIFICATION

1.1 DVI BOOT MOLDED WITH SNOW WHITE PVC RESIN P/N.

1.1.1 UL94V-0

1.1.2 HARDNESS (DUROMETER): SHORE A 90-95

1.2 HDMI OUTER MOLD WITH BLACK PVC RESIN. UL94V-0.

2. MECHANICAL SPECIFICATION

2.1 CABLE SHOULD STAND THE PULL FORCE 89-111N FOR 30 SECONDS WITH NO VISIBLE TERMINATION DAMAGE.

2.2 CABLE SHOULD PASS THE FLEX TEST IN 100 CYCLES AT EACH OF PLANES, PER EIA 364-41, CONDITION 1.

3. CABLE ELECTRICAL SPECIFICATION

3.1 DIELECTRIC STRENGTH: 300V AC FOR 10MS.

3.2 INSULATION RESISTANCE: 10 MEGA Ohms MIN.

3.3 DIFFERENTIAL LINES CHARACTERISTIC IMPEDANCE: 100+/-10 Ohms @TDR.

3.4 CONTACT RESISTANCE: 2 OHMS(MAX.).

3.5 SIGNALS CROSSTALK(FEXT): 5% (MAX.) PER ANSI/EIA-364-90.







3.6 SIGNALS INTRA-PAIR SKEW : <150 ps.

4. DVI CONNECTOR SPECIFICATION

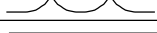
4.1 REFER TO PRODUCT SPEC. PS74320-0001.

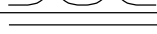
4.2 CONTACT PLATING: AU FLASH.

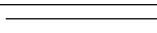
5. MATERIAL MUST MEET MANAGEMENT REGULATIONS FOR ENVIRONMENT (MX TS-0002).

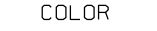
SHIELD	SHIELD		GROUND
PIN 19	PIN 16	=====	HOT PLUG DETECT
PIN 18	PIN 14	=====	POWER +5V
PIN 17	PIN 15	=====	GROUND(+5V&DDC)
PIN 16	PIN 7	=====	DDC DATA(SDA)
PIN 15	PIN 6	=====	DDC CLOCK(SCL)
PIN 11	PIN 22	=====	TMDS CLOCK SHIELD
PIN 12	PIN 24		TMDS CLOCK-
PIN 10	PIN 23		TMDS CLOCK+
PIN 8	PIN 19	=====	TMDS DATA 0 SHIELD
PIN 9	PIN 17		TMDS DATA 0-
PIN 7	PIN 18		TMDS DATA 0+
PIN 5	PIN 11	=====	TMDS DATA 1 SHIELD
PIN 6	PIN 9		TMDS DATA 1-
PIN 4	PIN 10		TMDS DATA 1+
PIN 2	PIN 3	=====	TMDS DATA 2 SHIELD
PIN 3	PIN 1		TMDS DATA 2-
PIN 1	PIN 2		TMDS DATA 2+
HDMI	DVI-D	COLOR	CABLE FUNCTION

ITEM	DESCRIPTION	QTY.
D	HDMI PLUG ASSY'	1
C	DVI THUMB SCREW	2
B	DVI_D SINGLE CHANNEL G/F CONNECTOR	1
A	DVI SINGLE LINK CABLE (SEE TABLE)	1

EC NO. DRWN: CHK: APPR: C	DESCRIPTION REV	QUALITY SYMBOLS MAJOR ▼ = 0 CRITICAL ▽ = 5	GENERAL TOLERANCES: (UNLESS SPECIFIED) <table border="1"> <thead> <tr> <th></th> <th>mm</th> <th>INCH</th> </tr> </thead> <tbody> <tr> <td>4 PLACES</td> <td>±0.</td> <td>±.</td> </tr> <tr> <td>3 PLACES</td> <td>±0.</td> <td>±.</td> </tr> <tr> <td>2 PLACES</td> <td>±0.</td> <td>±.</td> </tr> <tr> <td>1 PLACE</td> <td>±0.</td> <td>±.</td> </tr> </tbody> </table>		mm	INCH	4 PLACES	±0.	±.	3 PLACES	±0.	±.	2 PLACES	±0.	±.	1 PLACE	±0.	±.	SCALE N.S.T DESIGN UNITS <input checked="" type="checkbox"/> mm <input type="checkbox"/> INCH THIRD ANGLE PROJECTION <input type="checkbox"/> mm INCH <input type="checkbox"/> INCH mm <input checked="" type="checkbox"/> mm ONLY	DRAWN BY & DATE Louis Chen 03/11/17 CHECKED BY & DATE Teddy Kan 03/11/17 APPROVED BY & DATE Boron Chen 03/11/17	TITLE: HDMI(M) TO DVI-D(M) CABLE ASS'Y  MOLEX INCORPORATED	SHT REV
			mm	INCH																		
		4 PLACES	±0.	±.																		
		3 PLACES	±0.	±.																		
2 PLACES	±0.	±.																				
1 PLACE	±0.	±.																				
CAD FILENAME S88768AA.S02	MATERIAL NO. SEE TABLE	DRAWING NO. SD-88768-001	SHEET NO. 2 OF 2																			
THIS DRAWING CONTAINS INFORMATION THAT IS PROPRIETARY TO MOLEX INCORPORATED AND SHOULD NOT BE USED WITHOUT WRITTEN PERMISSION.				SIZE A4																		

REVISIONS				
ECN NO	DATE	REV.	DESCRIPTION	CHANGER
CY14-5154	2013/08/30	G	CHANGE THE LABELING CONTENT AND UPDATE NOTE FOR PRODUCTS TRANSFER TO PHILIPPINES	AHOU

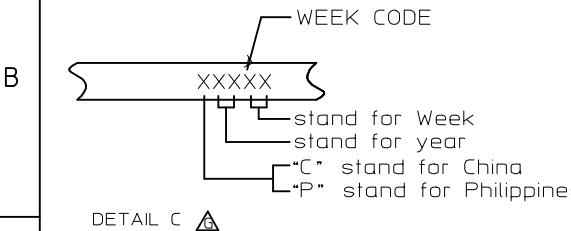
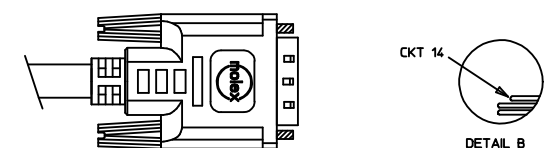
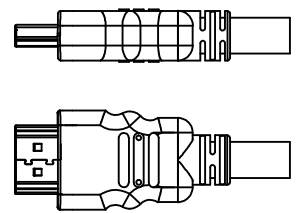
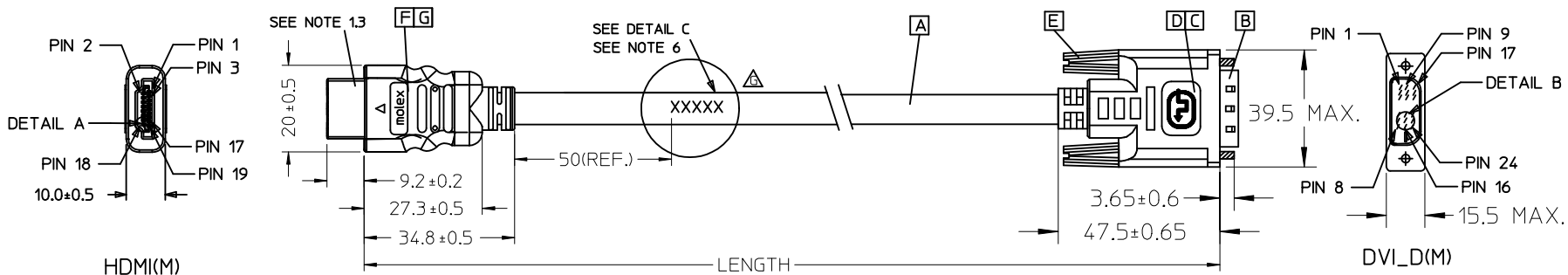

▲	887683530	HDMI TO DVI-D(M) CABLE ASS'Y.5M	5000 ± 100	BLACK	7.3MM(TMDS - AWG#28)
▲	887683520	HDMI TO DVI-D(M) CABLE ASS'Y.3M	3000 ± 80	BLACK	7.3MM(TMDS - AWG#28)
▲	887683510	HDMI TO DVI-D(M) CABLE ASS'Y.2M	2000 ± 60	BLACK	7.3MM(TMDS - AWG#28)
▲	887683500	HDMI TO DVI-D(M) CABLE ASS'Y.1M	1000 ± 30	BLACK	7.3MM(TMDS - AWG#28)
MX P/N	DESCRIPTION	LENGTH	CABLE COLOR	CABLE OD	

ENTER DESCRIPTION EC NO: CPG2014-0686 DRWN: XJGU001 CHKD: AHOU APPR: XAWANG 2013/09/06 2013/09/06 2013/09/12	QUALITY SYMBOLS ▽=0 ▽=0	GENERAL TOLERANCES (UNLESS SPECIFIED)		DIMENSION STYLE MM ONLY		SCALE ---	DESIGN UNITS METRIC	THIRD ANGLE PROJECTION	
			mm	INCH	DRAWN BY	DATE	TITLE HDMI(M) TO DVI-D(M) CABLE ASS'Y		
		4 PLACES	± ---	± ---	FZHANG01	2011/05/05			
		3 PLACES	± ---	± ---	CHECKED BY	DATE			
			2 PLACES	± ---	± ---	YHXU	2011/05/05		
			1 PLACE	± ---	± ---	APPROVED BY	DATE		
DRAFT WHERE APPLICABLE MUST REMAIN WITHIN DIMENSIONS			ANGULAR ± ---°		ZXDENG 2011/05/11		MOLEX INCORPORATED		
			MATERIAL NO. 8876835xx		DOCUMENT NO. SD-88768-35XX		SHEET NO. 1 OF 2		
			SIZE A 4		THIS DRAWING CONTAINS INFORMATION THAT IS PROPRIETARY TO MOLEX INCORPORATED AND SHOULD NOT BE USED WITHOUT WRITTEN PERMISSION				

△ NOTE:

1. OVERMOLD SPECIFICATION:
 - 1.1 DVI BOOT MOLDED SNOW WHITE PVC RESIN 887800076, UL94V-0.
 - 1.2 HDMI INNER MOLDED WITH PVC RESIN
HDMI OUTER MOLDED WITH PVC RESIN
 - 1.3 DUST COVER MOLDED WITH PE
2. THE CODE PLEASE BE PRINTED ON THE SPACE
3. PRODUCT ELECTRICAL SPECIFICATION:
 - 3.1 HI-POT VOLTAGE: 300V DC FOR 10mS
 - 3.2 INSULATION RESISTANCE: 10 MEGA Ohms MIN.
 - 3.3 CONTACT RESISTANCE: 2 OHMS MAX. FOR 1&2&3M; 3 OHMS MAX. FOR 5M;
 - 3.4 DIFFERENTIAL LINES CHARACTERISTIC IMPEDANCE: 100± 10 Ohms @TDR.
 - 3.5 SIGNALS CROSSTALK (FEXT) : 5% (MAX.) PER ANSI/EIA-364-90.
 - 3.6 SIGNALS INTRA-PAIR SKEW(PER CABLE): <150PS.
4. DVI CONNECTOR SPECIFICATION:
 - 4.1 REFER TO PRODUCT SPEC. PS74320-001
 - 4.2 CONTACT PLATING: AU FLASH.
5. THIS PRODUCT MUST MEET THE EU RoHS CHEMICAL SUBSTANCES SPECIFICATION FOR PRODUCTS (EU 2002/95/EC).
6. THE CODE PLEASE BE PRINTED ON THE SPACE.

SHIELD	SHIELD	OVERALL SHIELD	GROUND
PIN 19	PIN 16	WHITE	HOT PLUG DETECT
PIN 18	PIN 14	YELLOW	POWER +5V
PIN 17	PIN 15	ORANGE	GROUND(+5V&DDC)
PIN 16	PIN 7	RED	DDC DATA(SDA)
PIN 15	PIN 6	VIOLET	DDC CLOCK(SCL)
PIN 12	PIN 24	WHITE	TMDS CLOCK-
PIN 11	PIN 22	BRAID	TMDS CLOCK SHIELD
PIN 10	PIN 23	BROWN	TMDS CLOCK+
PIN 9	PIN 17	WHITE	TMDS DATA 0-
PIN 8	PIN 19	BRAID	TMDS DATA 0 SHIELD
PIN 7	PIN 18	BLUE	TMDS DATA 0+
PIN 6	PIN 9	WHITE	TMDS DATA 1-
PIN 5	PIN 11	BRAID	TMDS DATA 1 SHIELD
PIN 4	PIN 10	GREEN	TMDS DATA 1+
PIN 3	PIN 1	WHITE	TMDS DATA 2-
PIN 2	PIN 3	BRAID	TMDS DATA 2 SHIELD
PIN 1	PIN 2	RED	TMDS DATA 2+
HDMI	DVI-D	COLOR	CABLE FUNCTION

G	HDMI 19P MALE,30U"Au Solder Type	1
F	Metal Shell For HDMI 19P Male	1
E	DVI THUMB SCREW	2
D	PCB	1
C	ONE BODY CAN	1
B	DVI_D SINGLE CHANNEL G/F CONNECTOR	1
A	DVI SINGLE LINK CABLE (SEE TABLE)	1
ITEM	DESCRIPTION	QTY.

ENTER DESCRIPTION EC NO: CPG2014-0686 DRW: XJGU001 2013/09/06 CHKD: AHOU 2013/09/06 APPR: XAWANG 2013/09/12	QUALITY SYMBOLS ▽=0 ▽=0	GENERAL TOLERANCES (UNLESS SPECIFIED)		DIMENSION STYLE MM ONLY		SCALE ---	DESIGN UNITS METRIC	THIRD ANGLE PROJECTION		
						DRAWN BY DATE FZHANG01 2011/05/05		TITLE HDMI(M) TO DVI-D(M) CABLE ASS'Y		
						CHECKED BY DATE YHXU 2011/05/05				
						APPROVED BY DATE ZXDENG 2011/05/11		MOLEX INCORPORATED		
		ANGULAR ±---°		MATERIAL NO. 8876835xx		DOCUMENT NO. SD-88768-35XX		SHEET NO. 2 OF 2		
		DRAFT WHERE APPLICABLE MUST REMAIN WITHIN DIMENSIONS		THIS DRAWING CONTAINS INFORMATION THAT IS PROPRIETARY TO MOLEX INCORPORATED AND SHOULD NOT BE USED WITHOUT WRITTEN PERMISSION						

7 6 5 4 3 2 1

E

D

C

B

A

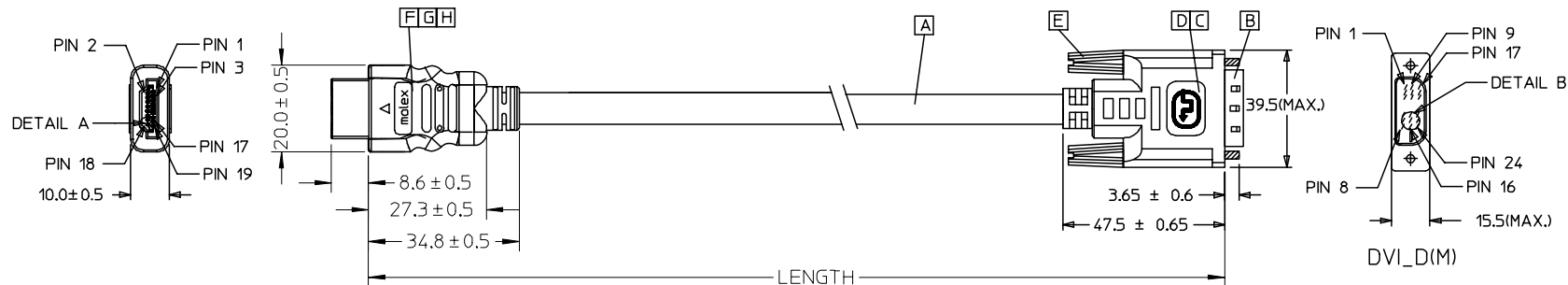

HDMI(M)

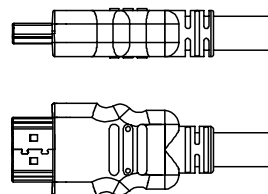
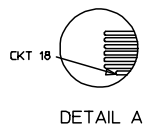

BACK SIDE

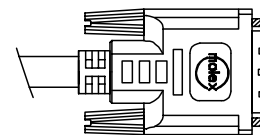

BACK SIDE

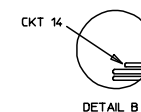

88768-3530	HDMI TO DVI-D(M) CABLE ASS'Y.5M	5000 ± 100	BLACK	7.3MM(TMDS - AWG#28)	887808276
88768-3520	HDMI TO DVI-D(M) CABLE ASS'Y.3M	3000 ± 80	BLACK	7.3MM(TMDS - AWG#28)	887808276
88768-3510	HDMI TO DVI-D(M) CABLE ASS'Y.2M	2000 ± 60	BLACK	7.3MM(TMDS - AWG#28)	887808276
88768-3500	HDMI TO DVI-D(M) CABLE ASS'Y.1M	1000 ± 30	BLACK	7.3MM(TMDS - AWG#28)	887808276
MX P/N	DESCRIPTION	LENGTH	CABLE COLOR	CABLE OD	CABLE P/N

ENTER DESCRIPTION EC NO: DG2006-0144 DRWN: JFZHENG CHKD: APPR: DQLUO	QUALITY SYMBOLS ▽=0 ◻=0	GENERAL TOLERANCES (UNLESS SPECIFIED)		DIMENSION STYLE MM ONLY		SCALE ---	DESIGN UNITS METRIC	THIRD ANGLE PROJECTION
			mm	INCH	DRAWN BY	DATE	TITLE	
		4 PLACES	±---	±---	JFZHENG	2005/12/26	#28 HDMI TO DVI 1M CABLE ASS'Y	
		3 PLACES	±---	±---	CHECKED BY	DATE		
2 PLACES	±---	±---	JFZHENG	2005/12/26				
1 PLACE	±---	±---	APPROVED BY	DATE				
		ANGULAR ±---°	DQLUO	2005/12/26				
		DRAFT WHERE APPLICABLE MUST REMAIN WITHIN DIMENSIONS	MATERIAL NO.	DOCUMENT NO.	SHEET NO.			
			ENTER PART	SD-887683510	1 OF 00			
			SIZE A 4	THIS DRAWING CONTAINS INFORMATION THAT IS PROPRIETARY TO MOLEX INCORPORATED AND SHOULD NOT BE USED WITHOUT WRITTEN PERMISSION				

6 5 4 3 2 1

NOTE:

1. OVERMOLD SPECIFICATION:
 - 1.1 DVI BOOT MOLDED SNOW WHITE PVC RESIN 887800076,UL94V-0.
 - 1.2 HDMI INNERMOLD WITH BK PVC 887800019.
HDMI OVERMOLD WITH PVC 887800150
 - 1.3 HDMI DUST COVER WITH PE 887800008

2. MECHANICAL SPECIFICATION
 - 2.1 CABLE SHOULD STAND THE PULL FORCE 89-111N FOR 30 SECONDS WITH NO VISIBLE TERMINATION DAMAGE.
 - 2.2 CABLE SHOULD PASS THE FLEX TEST IN 100 CYCLES AT EACH OF PLANES, PER EIA 364-41, CONDITION 1.
3. PRODUCT ELECTRICAL SPECIFICATION:
 - 3.1 DIELECTRIC STRENGTH.
 - 3.2 INSULATION RESISTANCE.
 - 3.3 CONDUCTIVE RESISTANCE.
 - 3.4 TMDS Signals Time Domain Impedence
 - 3.5 TMDS Signals Time Domain Crosstalk:FEXT
 - 3.6 TMDS Signals Skew
 - 3.7 Attenuation

REFER TO ES-002 ELECTRICAL SPECIFICATION FOR DETAILS.

4. CABLE CONSTRUCTION(CABLE
(AWG#28*1P+D)*4 + AWG#28*1P + AWG#28*3C, 7.3MMOD
5. DVI CONNECTOR SPECIFICATION(DVI
 - 5.1 REFER TO PRODUCT SPEC. PS74320-001
 - 5.2 CONTACT PLATING: AU FLASH.
6. THIS PRODUCT MUST MEET ROHS COMPLIANCE.

SHIELD	SHIELD	OVERALL SHIELD	GROUND
PIN 19	PIN 16	WHITE	HOT PLUG DETECT
PIN 18	PIN 14	YELLOW	POWER +5V
PIN 17	PIN 15	ORANGE	GROUND(+5V&DDC)
PIN 16	PIN 7	RED	DDC DATA(SDA)
PIN 15	PIN 6	VIOLET	DDC CLOCK(SCL)
PIN 12	PIN 24	WHITE	TMDS CLOCK-
PIN 11	PIN 22	BRAID	TMDS CLOCK SHIELD
PIN 10	PIN 23	BROWN	TMDS CLOCK+
PIN 9	PIN 17	WHITE	TMDS DATA 0-
PIN 8	PIN 19	BRAID	TMDS DATA 0 SHIELD
PIN 7	PIN 18	BLUE	TMDS DATA 0+
PIN 6	PIN 9	WHITE	TMDS DATA 1-
PIN 5	PIN 11	BRAID	TMDS DATA 1 SHIELD
PIN 4	PIN 10	GREEN	TMDS DATA 1+
PIN 3	PIN 1	WHITE	TMDS DATA 2-
PIN 2	PIN 3	BRAID	TMDS DATA 2 SHIELD
PIN 1	PIN 2	RED	TMDS DATA 2+
HDMI	DVI-D	COLOR	CABLE FUNCTION

ITEM	DESCRIPTION	QTY.
H	HDMI METAL PLATED 47152-6009	1
G	HDMI METAL CAN 47152-4001	1
F	HDMI HOUSING ASSY' 47152-1100	1
E	DVI THUMB SCREW 887806077	2
D	PCB 887899569/887899570	1
C	ONE BODY CAN 887899392	1
B	DVI_D SINGLE CHANNEL G/F CONNECTOR 743230001	1
A	DVI SINGLE LINK CABLE (SEE TABLE)	1

ENTER DESCRIPTION EC NO: DG2006-0144 DRWN: JFZHENG CHKD: APPR: DQLUO	2005/12/27 2005/12/30 2006/01/16	QUALITY SYMBOLS ▽=0 ▽=5	GENERAL TOLERANCES (UNLESS SPECIFIED)		DIMENSION STYLE MM ONLY		SCALE ---	DESIGN UNITS METRIC	THIRD ANGLE PROJECTION		
			4 PLACES	± ---	± ---	DRAWN BY JFZHENG	DATE 2005/12/26	TITLE #28 HDMI TO DVI 1M CABLE ASS'Y			
			3 PLACES	± ---	± ---	CHECKED BY JFZHENG	DATE 2005/12/26				
2 PLACES	± ---	± ---	APPROVED BY DQLUO		DATE 2005/12/26	MOLEX MOLEX INCORPORATED					
1 PLACE	± ---	± ---	ANGULAR ± ---°			DOCUMENT NO. SD-887683510		SHEET NO. 2 OF 2			
DRAFT WHERE APPLICABLE MUST REMAIN WITHIN DIMENSIONS			MATERIAL NO.		THIS DRAWING CONTAINS INFORMATION THAT IS PROPRIETARY TO MOLEX INCORPORATED AND SHOULD NOT BE USED WITHOUT WRITTEN PERMISSION						

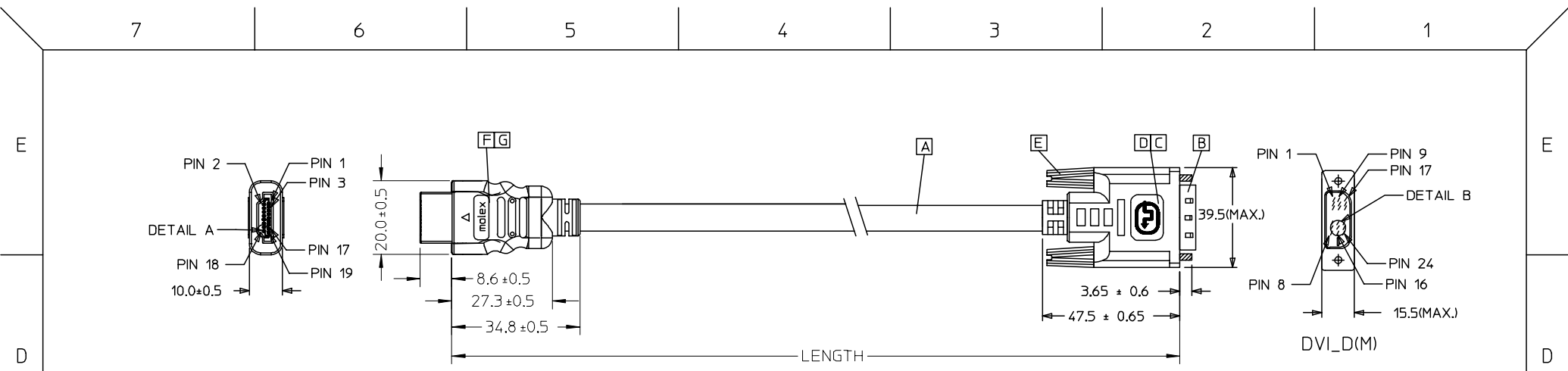

88768-3530	HDMI TO DVI-DIM) CABLE ASS'Y,5M	5000 ± 100	BLACK	7.3MM(TMDS - AWG#28)	887808276
88768-3520	HDMI TO DVI-DIM) CABLE ASS'Y,3M	3000 ± 80	BLACK	7.3MM(TMDS - AWG#28)	887808276
88768-3510	HDMI TO DVI-DIM) CABLE ASS'Y,2M	2000 ± 60	BLACK	7.3MM(TMDS - AWG#28)	887808276
88768-3500	HDMI TO DVI-DIM) CABLE ASS'Y,1M	1000 ± 30	BLACK	7.3MM(TMDS - AWG#28)	887808276
MX P/N	DESCRIPTION	LENGTH	CABLE COLOR	CABLE OD	CABLE P/N

ENTER DESCRIPTION EC NO: DG2005-0094 DRWN: JLIU13 2005/01/18 CHKD: TEDDY 2005/01/18 APPR: TKAN 2005/01/20	QUALITY SYMBOLS ▽=0 ◻=0	GENERAL TOLERANCES (UNLESS SPECIFIED)		DIMENSION STYLE		SCALE	DESIGN UNITS	THIRD ANGLE PROJECTION		
			mm	INCH	MM ONLY		---	METRIC		
		4 PLACES	± ---	± ---	DRAWN BY	DATE	TITLE			
		3 PLACES	± ---	± ---	JLIU13	2005/01/18	#28 HDMI TO DVI 2M CABLE ASS'Y			
2 PLACES	± ---	± ---	CHECKED BY	DATE						
1 PLACE	± ---	± ---	TEDDY	2005/01/18						
ANGULAR ± ---°				APPROVED BY	DATE					
				BORON	2005/01/18					
				MATERIAL NO.	DOCUMENT NO.	MOLEX MOLEX INCORPORATED				
				887683510	SD887683510			SHEET NO.		
				DRAFT WHERE APPLICABLE MUST REMAIN WITHIN DIMENSIONS				1 OF 2		
				THIS DRAWING CONTAINS INFORMATION THAT IS PROPRIETARY TO MOLEX INCORPORATED AND SHOULD NOT BE USED WITHOUT WRITTEN PERMISSION						

7 6 5 4 3 2 1

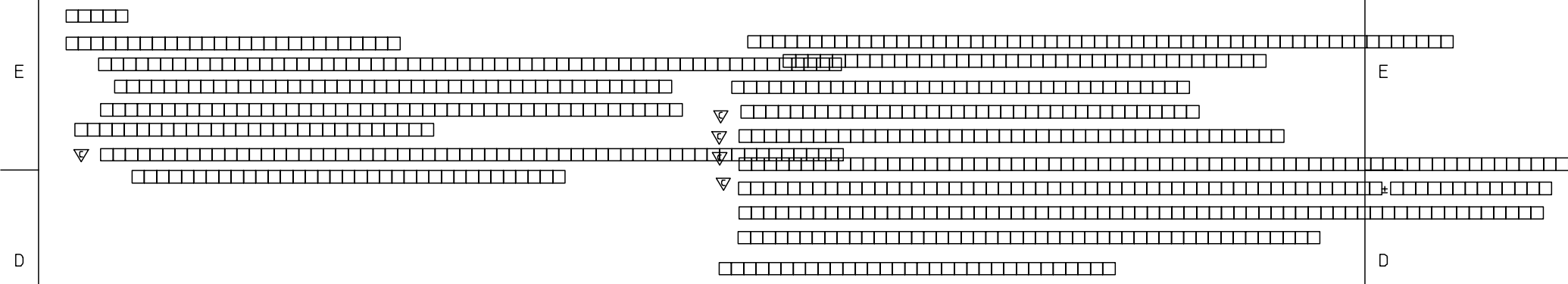

SHIELD	SHIELD	OVERALL SHIELD	GROUND
PIN 19	PIN 16	WHITE	HOT PLUG DETECT
PIN 18	PIN 14	YELLOW	POWER +5V
PIN 17	PIN 15	ORANGE	GROUND(+5V&DDC)
PIN 16	PIN 7	RED	DDC DATA(SDA)
PIN 15	PIN 6	VIOLET	DDC CLOCK(SCL)
PIN 12	PIN 24	WHITE	TMDS CLOCK-
PIN 11	PIN 22	BRAID	TMDS CLOCK SHIELD
PIN 10	PIN 23	BROWN	TMDS CLOCK+
PIN 9	PIN 17	WHITE	TMDS DATA 0-
PIN 8	PIN 19	BRAID	TMDS DATA 0 SHIELD
PIN 7	PIN 18	BLUE	TMDS DATA 0+
PIN 6	PIN 9	WHITE	TMDS DATA 1-
PIN 5	PIN 11	BRAID	TMDS DATA 1 SHIELD
PIN 4	PIN 10	GREEN	TMDS DATA 1+
PIN 3	PIN 1	WHITE	TMDS DATA 2-
PIN 2	PIN 3	BRAID	TMDS DATA 2 SHIELD
PIN 1	PIN 2	RED	TMDS DATA 2+
HDMI	DVI-D	COLOR	CABLE FUNCTION

G	HDMI METAL CAN 5011840118	1
F	HDMI HOUSING ASSY' 5011850001	1
E	DVI THUMB SCREW 887806077	2
D	PCB 887899569/887899570	1
C	ONE BODY CAN 887899392	1
B	DVI_D SINGLE CHANNEL G/F CONNECTOR 743230001	1
A	DVI SINGLE LINK CABLE (SEE TABLE)	1
ITEM	DESCRIPTION	QTY.

ENTER DESCRIPTION EC NO: DG2005-0094 DRWN: JLIU13 CHKD: TEDDY APPR: TKAN 2005/01/18 2005/01/18 2005/01/20 D REV	QUALITY SYMBOLS ▽=0 ▽=5	GENERAL TOLERANCES (UNLESS SPECIFIED)		DIMENSION STYLE MM ONLY		SCALE ---	DESIGN UNITS METRIC	THIRD ANGLE PROJECTION	
		4 PLACES ±--- ±---	3 PLACES ±--- ±---	DRAWN BY JLIU13	DATE 2005/01/18	TITLE #28 HDMI TO DVI 2M CABLE ASS'Y			
		2 PLACES ±--- ±---	1 PLACE ±--- ±---	CHECKED BY TEDDY	DATE 2005/01/18	APPROVED BY BORON			
		ANGULAR ±---°		MATERIAL NO. 887683510		DOCUMENT NO. SD887683510		SHEET NO. 2 OF 2	
DRAFT WHERE APPLICABLE MUST REMAIN WITHIN DIMENSIONS				THIS DRAWING CONTAINS INFORMATION THAT IS PROPRIETARY TO MOLEX INCORPORATED AND SHOULD NOT BE USED WITHOUT WRITTEN PERMISSION					

6 5 4 3 2 1