

HSMP-386D

PIN Diode Diversity Switch



Data Sheet

Description

The HSMP-386D is a low cost and high linearity diversity switch designed to operate from 50MHz to 6GHz. HSMP-386D is built with unique 4 PIN diode configuration, and it is housed in a industrial standard low cost miniature SOT-143 package, which will allow board space saving for space constraint application.

HSMP-386D is equipped with -0.35dB IL and -25.40dB ISO @ 900MHz. On the other hand, HSMP-386D is also featuring with 56.83dBm IIP3 and 47.41dBm IP1dB performance @ 900MHz. HSMP-386D is suitable for wireless application that required low distortion diversity switch, such as dect phone, wireless LAN and WiMAX.

Features

- Unique configurations in Surface Mount SOT-143
 - Increase Flexibility
 - Save Board Space
 - Reduce Cost
- Switching
 - Low Distortion Switching
 - Low Capacitance
- Low Failure In Time (FIT) Rate ^[1]
- Specifications at 900MHz; IF=10mA (Typ.)
 - Low IL, 0.35dB
 - High ISO, 25.40dB
 - High power handling, IP1dB, 47.41dBm
 - High Linearity, IIP3, 56.83dBm

Pin Connections and Package Marking, SOT-143

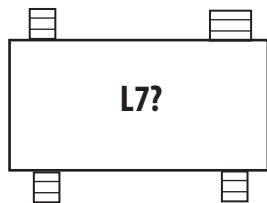
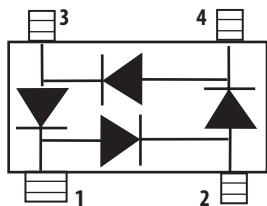

Notes:

L7 = Device Code

? = Month code indicates the month of manufacture

Table 1. Absolute Maximum Rating^[1] T_c = +25°C

Symbol	Parameter	Units	Absolute Max.
I _F	Forward Current (1μs Pulse)	Amp	1
P _{IV}	Peak Inverse Voltage	V	50
T _J	Junction temperature	°C	150
T _{STG}	Storage Temperature	°C	-65 to 150
θ _{JC}	Thermal Resistance ^[2]	°C/W	500

Notes:

1. Operation in excess of anyone of these conditions may result in permanent damage to the device.
2. T_c = 25°C, T_c where is defined to be the temperature at the package pins where contacts is made to the circuit board.

Table 2. Electrical Specifications, T_c = +25°C, each diode

Symbol	Parameter and Test Condition	Units	Min.	Typ	Max.
V _{BR}	Breakdown Voltage @ I _R = 10μA	V	–	55	–
V _F	Forward Voltage @ I _F = 30mA	V	–	0.88	–
V _F	Forward Voltage @ I _F = 100mA	V	–	0.96	1.15
R _S	Typical Series Resistance @ Freq = 100MHz & I _F = 1mA	Ohm	–	17.0	–
R _S	Typical Series Resistance @ Freq = 100MHz & I _F = 10mA	Ohm	–	2.6	–
R _S	Typical Series Resistance @ Freq = 100MHz & I _F = 100mA	Ohm	–	1.2	–
C _T	Typical Total Capacitance @ Freq = 1MHz & V _R = 0V	pF	–	0.35	0.55
T	Carrier Lifetime @ I _F = 50mA & I _R = 250mA	ns	–	500	–
T _{rr}	Reverse Recovery Time @ V _R = 10V, I _F = 20mA & 90% Recovery	ns	–	75	–

Table 3. Performance Table at Nominal Operating Conditions, T_c = +25°C, I_F = 10mA, each diode

IIP3 ^[1, 4]	Input 3rd order Intercept Point @ freq = 0.9GHz	dBm	–	56.83	–
IIP3 ^[2, 4]	Input 3rd order Intercept Point @ freq = 1.9GHz	dBm	–	57.93	–
IIP3 ^[3, 4]	Input 3rd order Intercept Point @ freq = 2.4GHz	dBm	–	59.26	–
IP1dB ^[4]	Input 1dB Compressed Power @ freq = 0.9GHz	dBm	–	47.41	–
IP1dB ^[4]	Input 1dB Compressed Power @ freq = 1.9GHz	dBm	–	48.11	–
IP1dB ^[4]	Input 1dB Compressed Power @ freq = 2.4GHz	dBm	–	48.45	–

Notes:

1. 0.9 GHz OIP3 Test Condition : F1 = 0.9 GHz & F2 = 0.905 GHz, Pin = 30 dBm
2. 1.9 GHz OIP3 Test Condition : F1 = 1.9 GHz & F2 = 1.905 GHz, Pin = 30 dBm
3. 2.4 GHz OIP3 Test Condition : F1 = 2.4 GHz & F2 = 2.405 GHz, Pin = 30 dBm
4. Measurement obtained using the demoboard described in Figure 7 & 8.

HSMP-386D Typical Performance, $T_c = +25^\circ\text{C}$, each diode

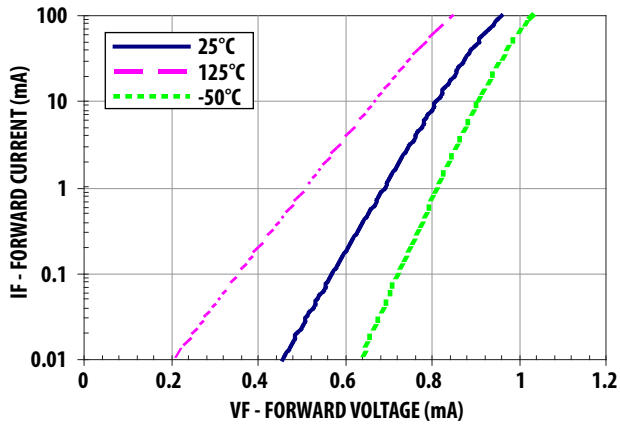

Figure 1. Forward Current vs. Forward Voltage

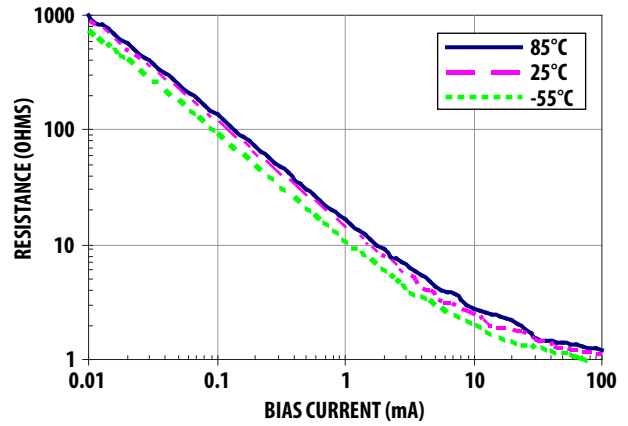

Figure 2. Typical RF Resistance vs. Forward Bias Current

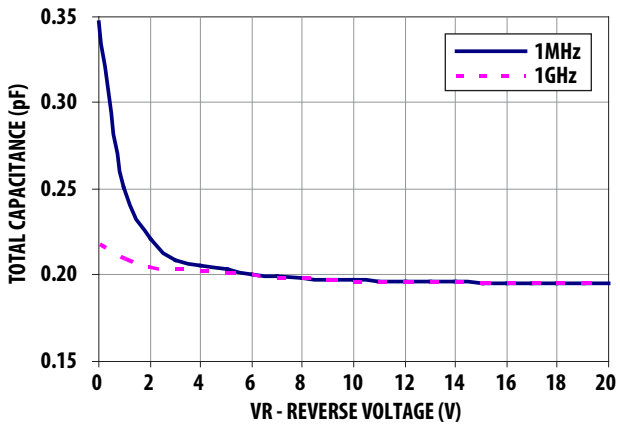

Figure 3. Total Capacitance vs. Reverse Voltage

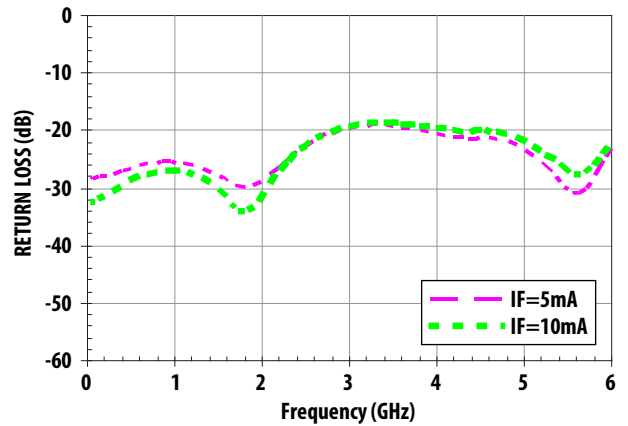

Figure 4. Return Loss vs. Frequency (Pin = 0dBm)

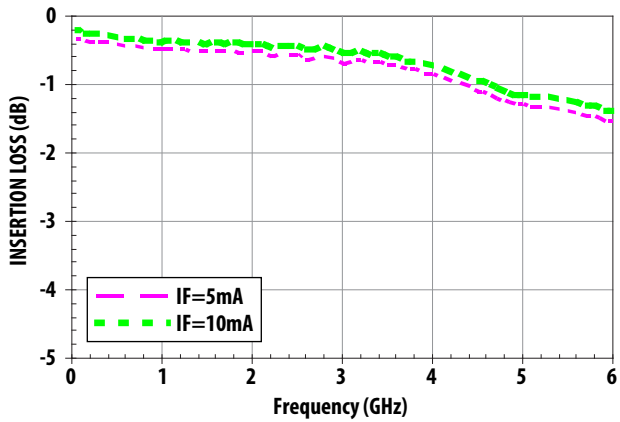

Figure 5. Insertion Loss vs. Frequency (Pin = 0dBm)

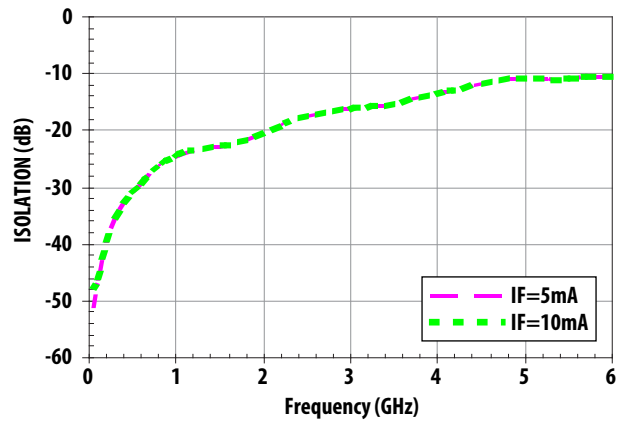

Figure 6. Isolation vs. Frequency (Pin = 0dBm)

Truth Table

CTR1 (V)	CTR2 (V)	Low Loss paths
V_F	0	RF4-RF3 RF1-RF2
0	V_F	RF3-RF1 RF2-RF4

APLAC Model Parameters for PIN Diode

Parameter	Units	PIN Diode
R_{MAX}	$K\Omega$	5
I_S	A	1.42 E-9
N		1.99
TT	ns	500
C	pF	0.20
A		0.0276
K		0.9018
R_{MIN}	Ω	1.10
L	nH	2

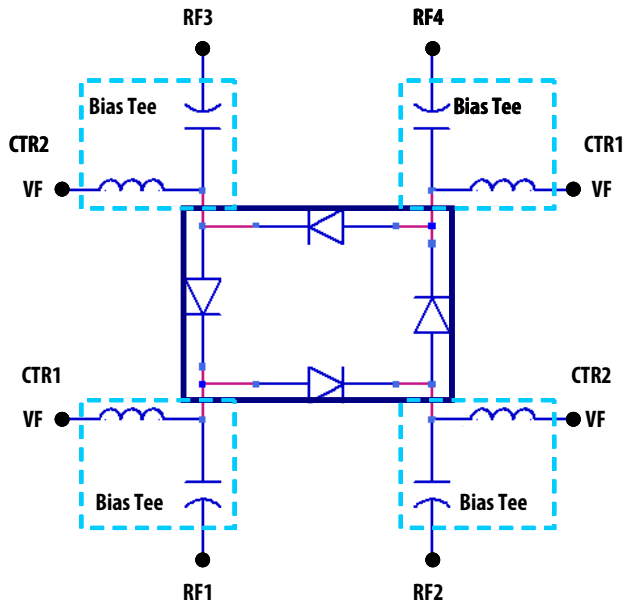

Figure 7. A diagram showing the application circuit for Diversity Switch using HSMF-386D.

This set-up is applicable for measurement shown in Figure 4 – 6.

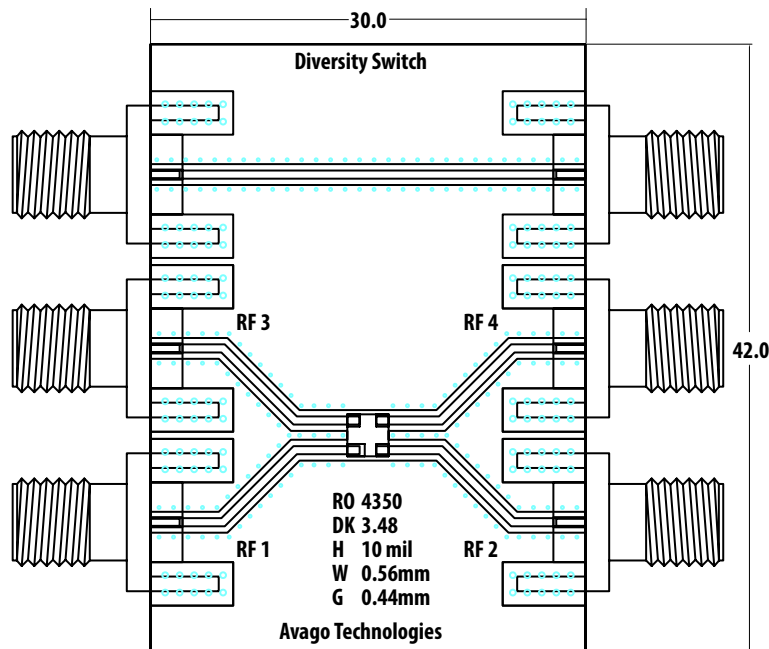
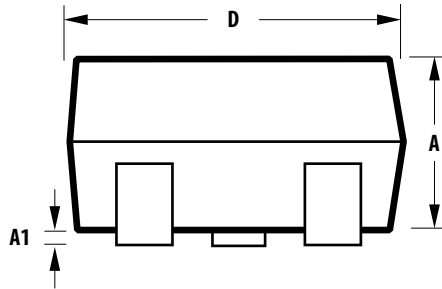
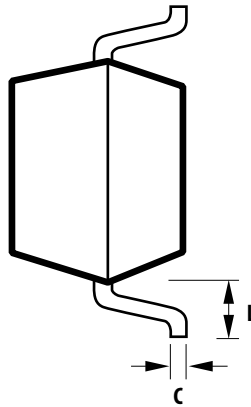
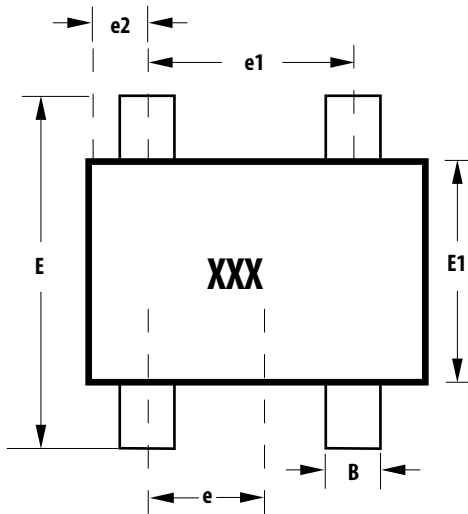

Figure 8. Evaluation Board for Diversity Switch

Package Outline, SOT-143



Notes:

XXX-package marking

Drawings are not to scale

SYMBOL	DIMENSIONS (mm)	
	MIN.	MAX.
A	0.79	1.097
A1	0.013	0.10
B	0.36	0.54
B1	0.76	0.92
C	0.086	0.152
D	2.80	3.06
E1	1.20	1.40
e	0.89	1.02
e1	1.78	2.01
e2	0.45	0.60
E	2.10	2.65
L	0.45	0.69

Part Number Ordering Information

Part Number	No. of Devices	Container
HSMP-386D-BLK	100	Bulk, per Antistatic bag
HSMP-386D-TR1	3000	Tape & Reel, per 7" Reel
HSMP-386D-TR2	10000	Tape & Reel, per 13" Reel

Tape and Reeling conforms to Electronic Industries RS-481, "Taping of Surface Mounted Components for Automated Placement".

For lead-free option, the part number will have the character "G" at the end, eg. -TR2G for a 10K pc lead-free reel.

Tape Dimensions and Product Orientation

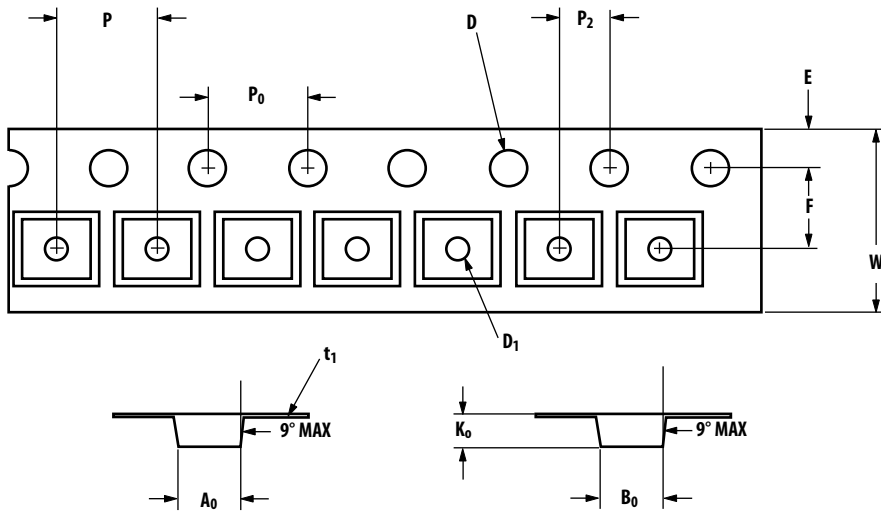

DESCRIPTION		SYMBOL	SIZE (mm)	SIZE (INCHES)
CAVITY	LENGTH	A_0	3.19 ± 0.10	0.126 ± 0.004
	WIDTH	B_0	2.80 ± 0.10	0.110 ± 0.004
	DEPTH	K_0	1031 ± 0.10	0.052 ± 0.004
	PITCH	P	4.00 ± 0.10	0.157 ± 0.004
	BOTTOM HOLE DIAMETER	D_1	1.00 ± 0.25	0.039 ± 0.010
PERFORATION	DIAMETER	D	1.50 ± 0.10	0.059 ± 0.004
	PITCH	P_0	4.00 ± 0.10	0.157 ± 0.004
	POSITION	E	1.75 ± 0.10	0.069 ± 0.004
CARRIER TAPE	WIDTH	W	$8.00 + 0.30 - 0.10$	$0.315 + 0.012 - 0.004$
	THICKNESS	t_1	0.254 ± 0.013	0.0100 ± 0.0005
DISTANCE	CAVITY TO PERFORATION (WIDTH DIRECTION)	F	3.50 ± 0.05	0.138 ± 0.002
	CAVITY TO PERFORATION (LENGTH DIRECTION)	P_2	2.00 ± 0.05	0.079 ± 0.002

For product information and a complete list of distributors, please go to our web site: www.avagotech.com

Avago, Avago Technologies, and the A logo are trademarks of Avago Technologies in the United States and other countries. Data subject to change. Copyright © 2005-2009 Avago Technologies. All rights reserved.
AV02-1689EN - January 13, 2009

AVAGO
TECHNOLOGIES