

ERK610Z681KUAR

Aliases (C812UA681K440X, ERK610RK3680KUAR)

Obsolete

ERK610 SFTY X1-440 Y2-300, Ceramic, 680 pF, 10%, 440 VAC (X1), 300 VAC (Y2), Y5U, Lead Spacing = 5mm

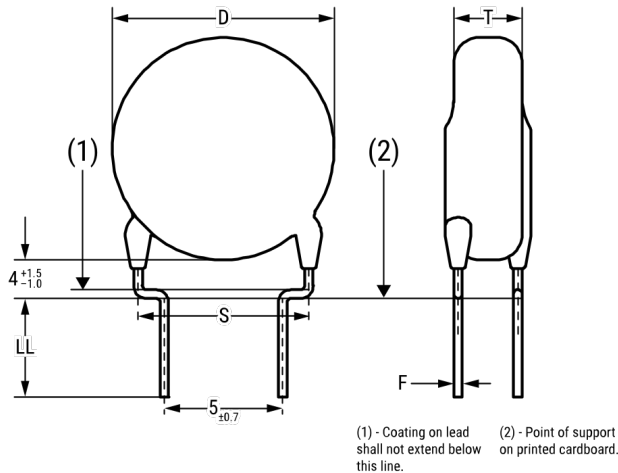

Click [here](#) for the 3D model.

Dimensions

D	9mm MAX
T	6mm MAX
S	5mm +/-0.7mm
H0	16mm +/-0.5mm
F	0.6mm +/-0.05mm
V	2mm +/-0.5mm

Packaging Specifications

Packaging T&R, H0 = 16mm, Component Pitch = 12.7mm

General Information

Series	ERK610 SFTY X1-440 Y2-300
Style	Radial Disc
Description	Ceramic Single Layer Safety Disc Capacitors
RoHS	Yes
Termination	Tin
Qualifications	UL, CSA, CAN, ENEC, VDE
AEC-Q200	No
Notes	Please See Bulletin For Taping Information. H0 Dimension Refers to Seating Plane To Center Hole of Tape.

Specifications

Capacitance	680 pF
Capacitance Tolerance	10%
Voltage AC	440 VAC (X1), 300 VAC (Y2)
Temperature Range	-40/+125°C
Temperature Coefficient	Y5U
Dissipation Factor	2.5%
Insulation Resistance	6 GOhms
Safety Class	X1/Y2