

Data sheet

Order No.: 1156862

Type: FQ 1,27D/ 20-PV- 160-1-BR

SMD pin header, Reflow soldering

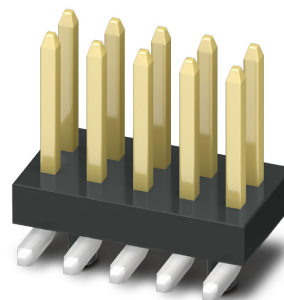

The figure shows the 10-pos. version

1 Main features



- | | | | |
|----------------|--------------|------------------------|-----------------|
| • No. of pos. | 20 | • Nominal current | 1 A |
| • Test voltage | 500 V AC | • Mounting type | SMD soldering |
| • Color | black (9005) | • Connection direction | 90 ° |
| • Pitch | 1.27 mm | • Type of packaging | 24 mm wide tape |

2 Your advantages

- ✓ Reliable mechanical and electrical connections thanks to the double-sided contact system
- ✓ Designed for integration into the SMT soldering process
- ✓ Clear and cost-optimized design
- ✓ Suitable for a multitude of applications



Make sure you always use the latest documentation.

It can be downloaded at: phoenixcontact.net/product/1156862

3 Table of contents

1	Main features.....	1
2	Your advantages	1
3	Table of contents	2
4	General Technical Data	3
5	Mounting.....	4
6	Dimensions.....	5
7	Series drawing.....	6
8	Product notes	7
9	Packaging information	7
10	Blister drawing.....	8
11	Application.....	9
12	General tests	10
13	Mechanical tests.....	11
14	Electrical tests	12
15	Current carrying capacity/derating curves	13
16	Commercial Data.....	14
17	Combination tests.....	15

1156862 FQ 1,27D/ 20-PV- 160-1-BR**4 General Technical Data****4.1 item properties**

Order No.	1156862
Type	FQ 1,27D/ 20-PV- 160-1-BR
Connector system	FINEPITCH FQ 1,27
Product type	SMD pin header
Type of contact	Male connector
Range of articles	FQ 1,27D/...-PV
Pitch	1.27 mm
Number of positions	20
Number of levels	2
Type of locking	without
Mounting type	SMD soldering
Connection direction of the connector to the PCB	90 °
Pin layout	Linear pad geometry

1156862 FQ 1,27D/ 20-PV- 160-1-BR**5 Mounting****5.1 Flange mounting**

Type of locking	without
-----------------	---------

5.2 Material of metal parts

Note	WEEE/RoHS-compliant, whisker-free acc. to IEC 60068-2-82/JEDEC JESD 201
Contact material	Cu alloy
Surface contact area	Nickel (Ni) , Gold (Au)
Soldering area surface	Tin (Sn)
Surface characteristics	Selective coating
Insulating material data	Housing
Color	black (9005)
Insulating material	PA
Insulating material group	I
CTI according to IEC 60112	600
Flammability rating according to UL 94	V0

1156862 FQ 1,27D/ 20-PV- 160-1-BR**6 Dimensions****6.1 Dimensions for the product**

Length	5.5 mm
Width	12.7 mm
Total height	6 mm
Installed height	5.1 mm
Coplanarity	≤ 0.1 mm

6.2 Dimensions for the application

Contact cover	0.4 mm
Overlap length	1.3 mm
Stacking height	6.2 mm Tolerance: +1.3 mm (in combination with Range of articles:FQ 1,27D/...-SV)

1156862 FQ 1,27D/ 20-PV- 160-1-BR

7 Series drawing

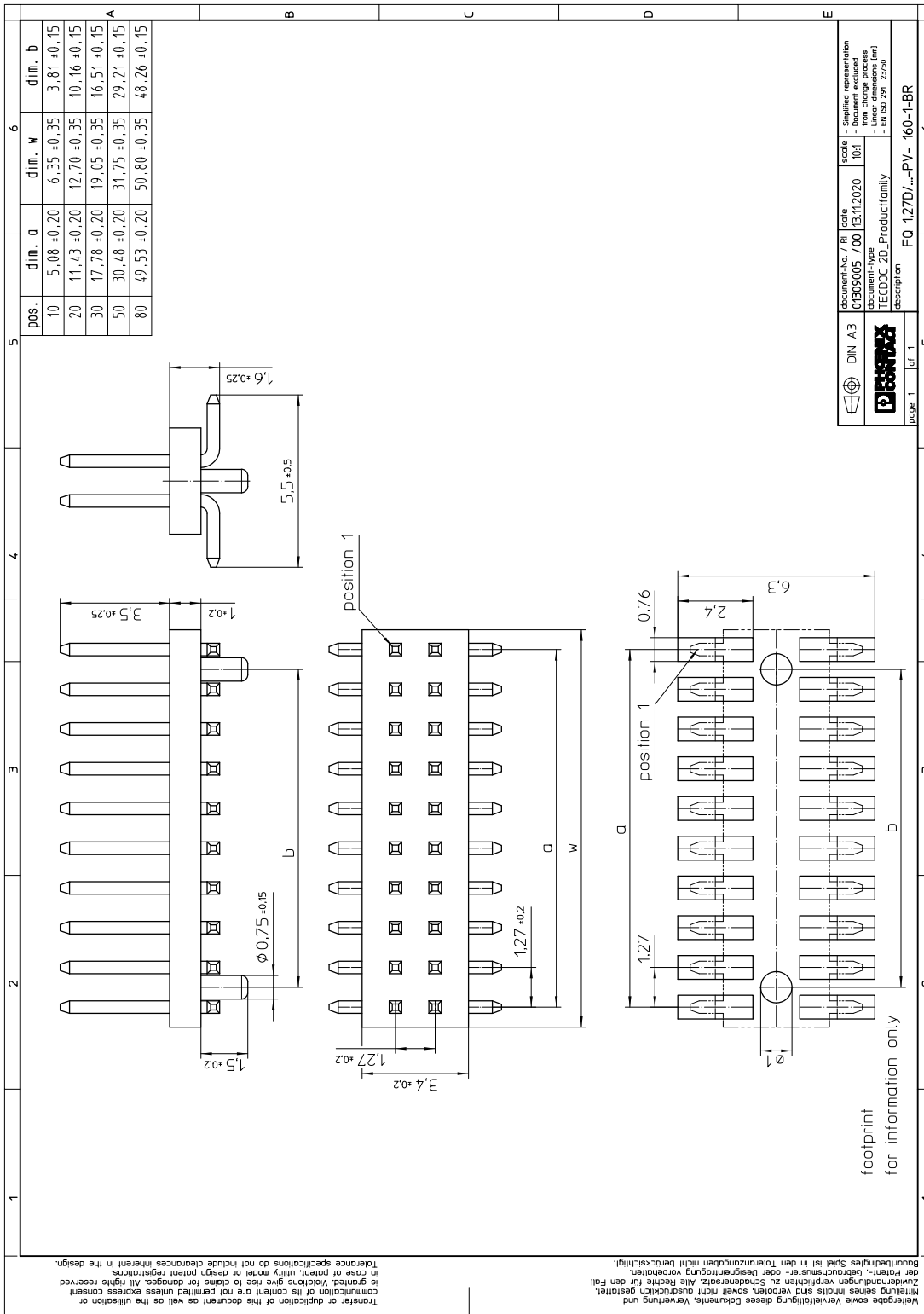

1156862 FQ 1,27D/ 20-PV- 160-1-BR**8 Product notes****8.1 General information**

Notes on operation

The permissible voltage during operation depends on the application, taking into consideration the air clearances and creepage distances within the scope of insulation requirements in accordance with IEC 60664-1.

9 Packaging information

Type of packaging	24 mm wide tape
Pieces per package	700
Outer packaging type	Transparent-Bag
ESD level	(D) electrostatically conductive
Specification	DIN EN 61340-5-1 (VDE 0300-5-1): 2008-07
[W] tape width	24 mm
[A] coil diameter	330 mm
[W2] coil overall dimension	30.4 mm
Number of products per coil	700

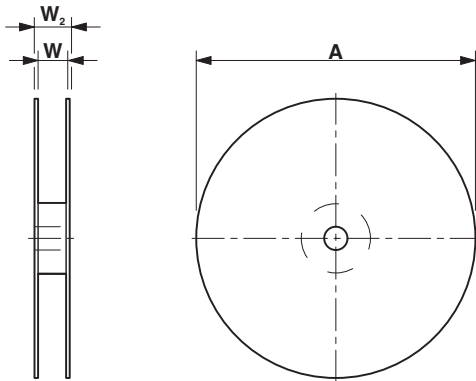

1156862 FQ 1,27D/ 20-PV- 160-1-BR

10 Blister drawing

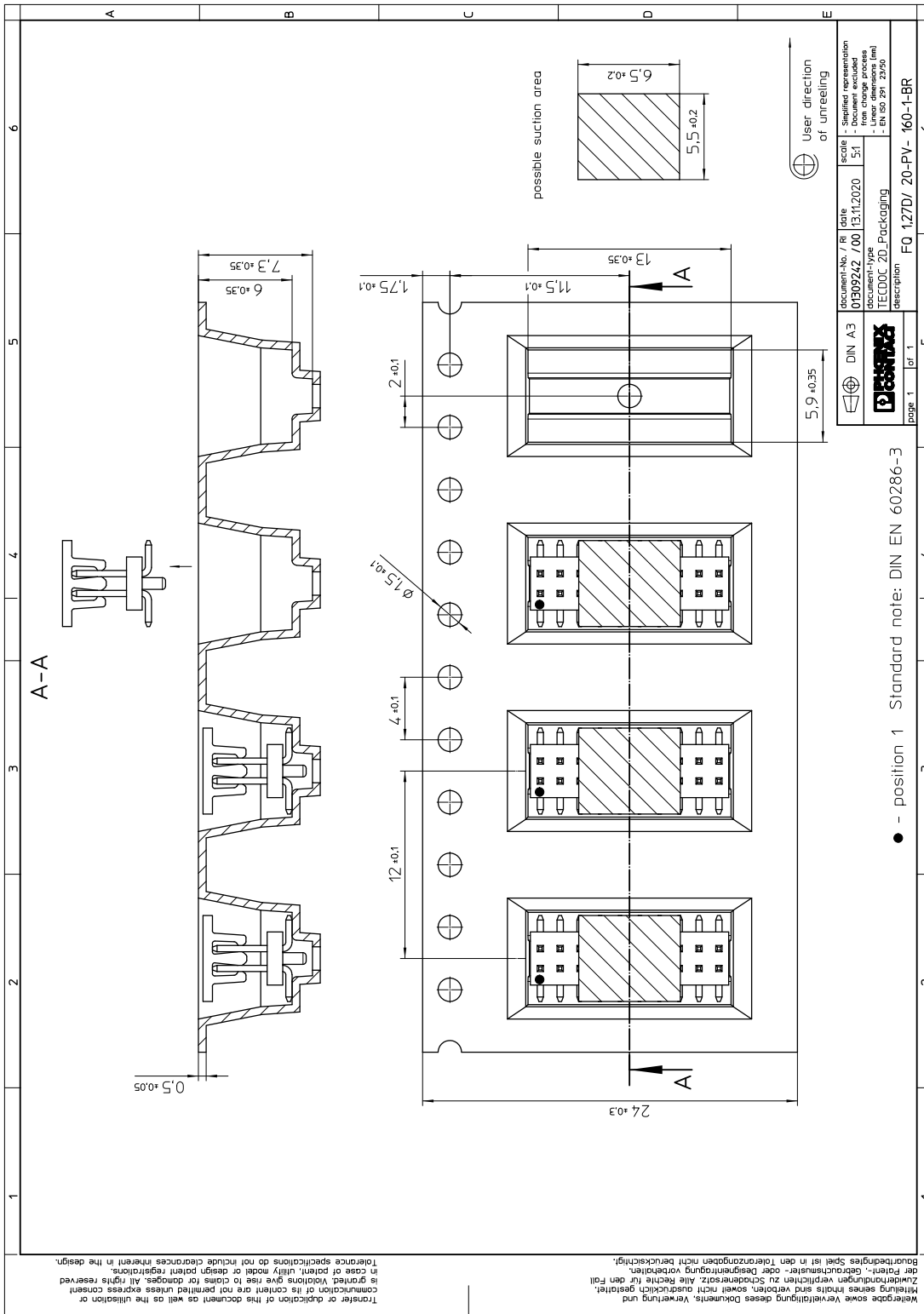

11 Application

11.1 Temperature limit values

Ambient temperature (storage/transport)	-40 °C ... 70 °C
Ambient temperature (assembly)	-5 °C ... 100 °C
Ambient temperature (operation)	-40 °C ... 125 °C

1156862 FQ 1,27D/ 20-PV- 160-1-BR

12 General tests

12.1 Specification



Brief description

Board-to-board connectors

1156862 FQ 1,27D/ 20-PV- 160-1-BR

13 Mechanical tests

13.1 Insertion and withdrawal force per contact

Insertion and withdrawal force per contact ≤ 1.2 N

Specification IEC 60512-9-1:2010-03 (following)

100 Insertion/withdrawal cycles

1156862 FQ 1,27D/ 20-PV- 160-1-BR**14 Electrical tests**

Nominal current at 20 °C	1 A IEC 60512-5-2:2002-02 (80-pos.)
Test voltage	500 V AC IEC 60512-4-1:2003

14.1 Air and creepage distances

Minimum value for clearance and creepage distance	0.25 mm
---	---------

1156862 FQ 1,27D/ 20-PV- 160-1-BR**15 Current carrying capacity/derating curves**

Specification	IEC 60512-5-2:2002-02
Note	max. 1 A at 20°C (80-pos.)
Reduction factor	0.8

Type: FQ 1,27D/...-SV- 490-1-BR with FQ 1,27D/...-PV- 160-1-BR

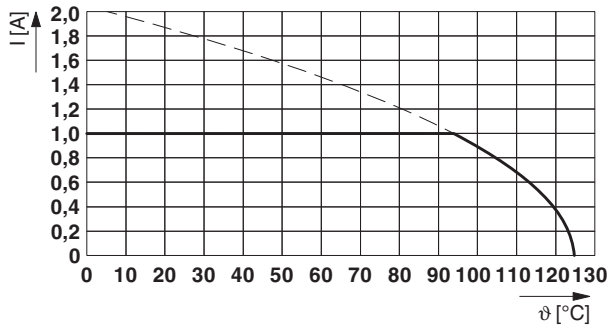
**15.1 Insulation resistance**

Insulation resistance	> 1 G Ω , (IEC 60512-3-1:2002-02)
-----------------------	--

15.2 forward resistance

Contact resistance	≤ 30 m Ω , (IEC 60512-2-1:2002-02)
--------------------	--

15.3 Vibration test

Specification	IEC 60068-2-6:2007-12
Result	Test passed
Frequency	10 - 55 - 10 Hz
Sweep speed	1 octave/min
Amplitude	1.52 mm
Acceleration	181 m/s ²
Test duration per axis	2 h
Test directions	X-, Y- and Z-axis
Note	

1156862 FQ 1,27D/ 20-PV- 160-1-BR

16 Commercial Data

Order No.	1156862
Type	FQ 1,27D/ 20-PV- 160-1-BR
Pieces per package	700
Net weight	2.22 g
GTIN	4063151160524
	Information that applies locally, see link on page 1

1156862 FQ 1,27D/ 20-PV- 160-1-BR

17 Combination tests

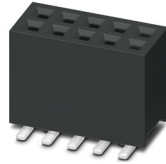
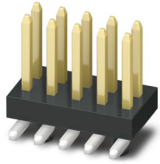
**FQ 1,27D/...-PV****FQ 1,27D/...-SV****Mechanical tests**

Insertion/withdrawal force per position

approx. 1.2 N / 1.2 N

Durability testsContact resistance R_1 20 m Ω

Insertion/withdrawal cycles

100

Contact resistance R_2 30 m Ω

Test voltage

500 V AC

Insulation resistance
Requirements > 5 M Ω > 1 G Ω **Thermal tests**

Tested number of positions

80

Test current

1 A