

**PLEASE CHECK WWW.MOLEX.COM FOR LATEST PART INFORMATION**

**Part Number:** [0510481100](#)  
**Status:** **Active**  
**Description:** 2.00mm Pitch Cable Holder, Vertical, Low Profile, for Ribbon Cable, 11 Circuits

**Documents:**

[3D Model](#) [RoHS Certificate of Compliance \(PDF\)](#)  
[Drawing \(PDF\)](#)

**General**

Product Family Ribbon Cable / Wire Trap Connectors  
 Series [51048](#)  
 Component Type One Piece  
 Glow-Wire Capable No  
 Product Name Board-in, Cable Holder  
 UPC 800753750906

**Physical**

Circuits (Loaded) 11  
 Color - Resin Natural  
 Entry Angle Vertical  
 Lock to Mating Part None  
 Material - Plating Mating N/A  
 Material - Resin Nylon  
 Net Weight 235.800/mg  
 Number of Rows 1  
 PCB Retention Yes  
 PCB Thickness - Recommended 1.60mm  
 Packaging Type Bag  
 Pitch - Mating Interface 2.00mm  
 Pitch - Termination Interface 2.00mm  
 Polarized to Mating Part N/A  
 Polarized to PCB No  
 Stackable No  
 Surface Mount Compatible (SMC) No  
 Temperature Range - Operating -40° to +105°C  
 Wire Insulation Diameter 1.60mm max.  
 Wire Size AWG 26  
 Wire/Cable Type Ribbon Cable

**Electrical**

Current - Maximum per Contact N/A  
 Voltage - Maximum N/A

**Material Info**

**Reference - Drawing Numbers**

Sales Drawing SD-51048-001

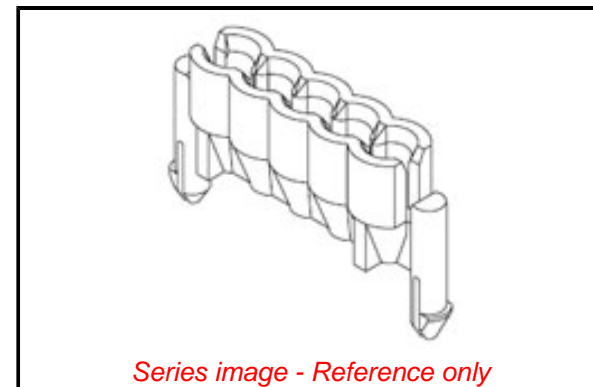

**EU ELV**

**Not Relevant**

**EU RoHS**

**Compliant**

**REACH SVHC**

Not Contained Per -  
 ED/71/2019 (16 July  
 2019)

**Halogen-Free**

**Status**

**Low-Halogen**

For more information, please visit [Contact US](#)

China ROHS

ELV

RoHS Phthalates

**China RoHS**

Green Image

Not Relevant

Not Contained

**Search Parts in this Series**

[51048 Series](#)

**Mates With**

N/A

**Use With**

Topcoated Ribbon Cable