



TO-252
(DPAK)



Pin Definition:

1. Input
2. Ground (tab)
3. Output

General Description

The TS78M05A Series positive voltage regulators are identical to the popular TS7805 Series devices, except that they are specified for only half the output current. Like the TS7805 devices, the TS78M05A Series 3-Terminal regulators are intended for local, on-card voltage regulation.

Internal current limiting, thermal shutdown circuitry and safe-area compensation for the internal pass transistor combine to make these devices remarkably rugged under most operating conditions. Maximum output current with adequate heatsink is 500mA

Features

- Output Voltage 5V
- Output current up to 500mA
- Internal thermal overload protection
- Internal short-circuit current limiting
- Output transistor safe-area compensation
- Output voltage offered in 2% tolerance

Ordering Information

Part No.	Package	Packing
TS78M05ACP ROG	TO-252	2.5Kpcs / 13" Reel

Note: "G" denotes for Halogen Free

Standard Application Circuit

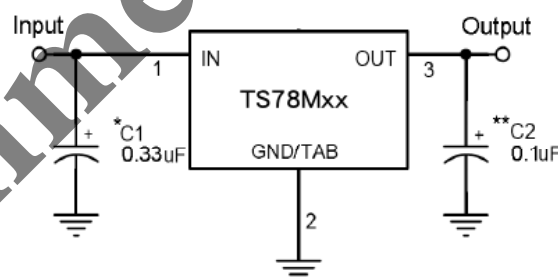

A common ground is required between the input and the output voltages. The input voltage must remain typically 2.0V above the output voltage even during the low point on the Input ripple voltage.

XX = these two digits of the type number indicate voltage.

* = Cin is required if regulator is located an appreciable distance from power supply filter.

** = Co is not needed for stability; however, it does improve transient response.

Absolute Maximum Rating (Ta = 25°C unless otherwise noted)

Parameter	Symbol	Limit	Unit
Input Voltage	V_{IN}^*	35	V
Power Dissipation	P_D	Internal Limited	W
Operating Junction Temperature	T_J	0~+125	°C
Storage Temperature Range	T_{STG}	-65~+150	°C
Thermal Resistance - Junction to Case	$R\theta_{JC}$	8	°C/W
Thermal Resistance - Junction to Ambient	$R\theta_{JA}$	100	°C/W

TS78M05A Electrical Characteristics

($V_{in}=10V$, $I_{out}=350mA$, $0^{\circ}C \leq T_j \leq 125^{\circ}C$, $C_{in}=0.33\mu F$, $C_{out}=0.1\mu F$; unless otherwise specified.)

Parameter	Symbol	Test Condition	Min	Typ	Max	Unit	
Output voltage	Vout	$T_j=25^{\circ}C$	4.90	5	5.10	V	
		$7.5V \leq V_{in} \leq 20V$, $5mA \leq I_{out} \leq 350mA$	4.80	5	5.20		
Line Regulation	REGline	$T_j=25^{\circ}C$	$7.5V \leq V_{in} \leq 25V$	--	3	100	mV
			$8V \leq V_{in} \leq 12V$	--	1	50	
Load Regulation	REGload	$T_j=25^{\circ}C$	$5mA \leq I_{out} \leq 500mA$	--	15	100	
			$5mA \leq I_{out} \leq 200mA$	--	5	50	
Quiescent Current	Iq	$I_{out}=0$, $T_j=25^{\circ}C$	--	3	6	mA	
Quiescent Current Change	ΔIq	$7.5V \leq V_{in} \leq 25V$	--	--	0.8		
		$5mA \leq I_{out} \leq 350mA$	--	--	0.5		
Output Noise Voltage	Vn	$10Hz \leq f \leq 100KHz$, $T_j=25^{\circ}C$	--	40	--	μV	
Ripple Rejection Ratio	RR	$f=120Hz$, $8V \leq V_{in} \leq 18V$	62	78	--	dB	
Voltage Drop	Vdrop	$I_{out}=500mA$, $T_j=25^{\circ}C$	--	2	--	V	
Output Resistance	Rout	$f=1KHz$	--	17	--	$m\Omega$	
Output Short Circuit Current	Ios	$T_j=25^{\circ}C$	--	50	--	mA	
Peak Output Current	I _{o peak}	$T_j=25^{\circ}C$	--	0.7	--	A	
Temperature Coefficient of Output Voltage	$\Delta V_{out} / \Delta T_j$	$I_{out}=5mA$, $0^{\circ}C \leq T_j \leq 125^{\circ}C$	--	-0.2	--	$mV/^{\circ}C$	

Not Recommended

Electrical Characteristics Curve

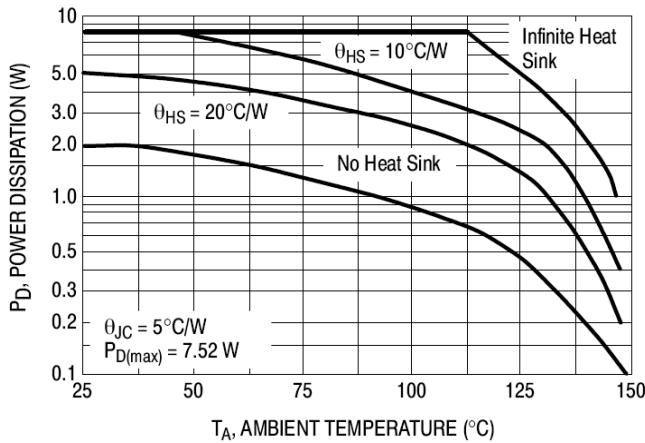

Figure 1. Worst Case Power Dissipation vs. Ambient Temperature (TO-220)

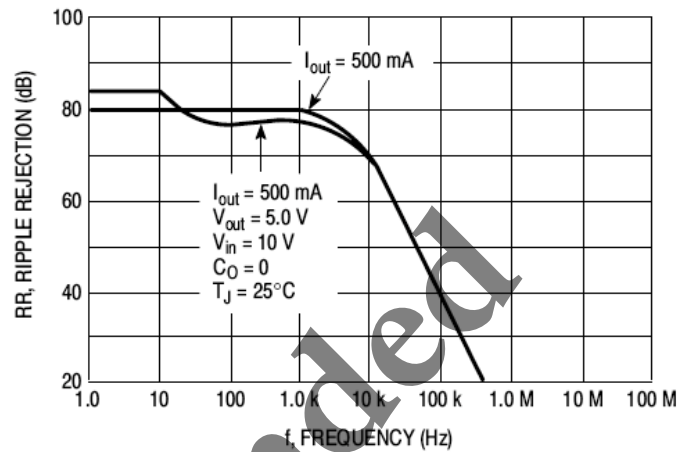

Figure 3. Ripple Rejection vs. Frequency

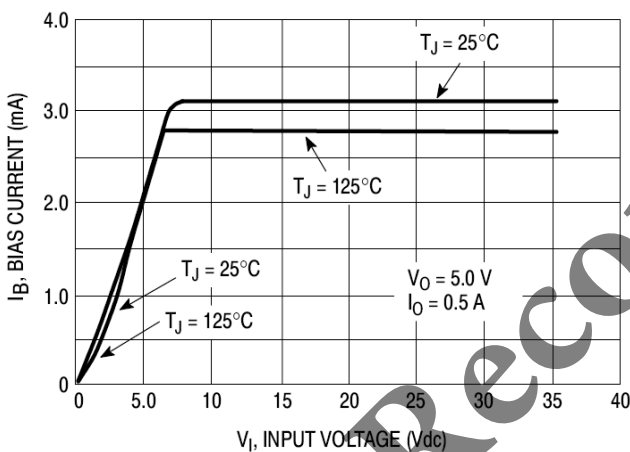

Figure 3. Bias Current vs. Input Voltage

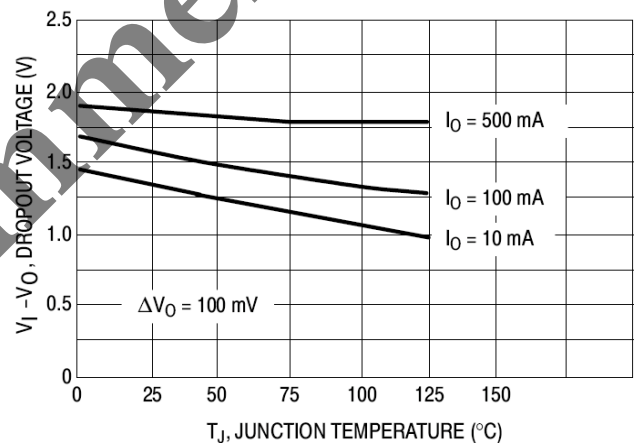

Figure 4. Dropout Voltage vs. Junction Temperature

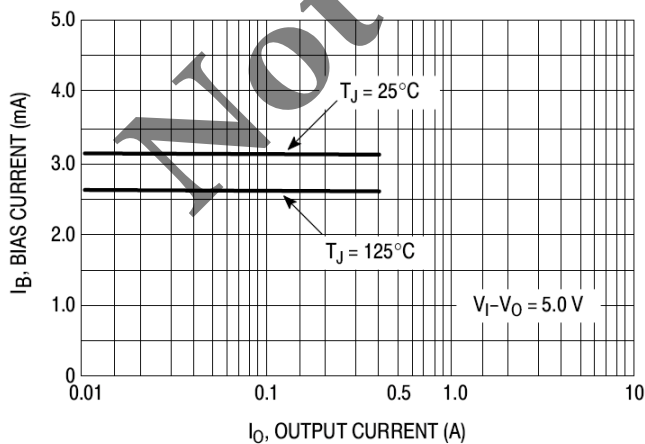
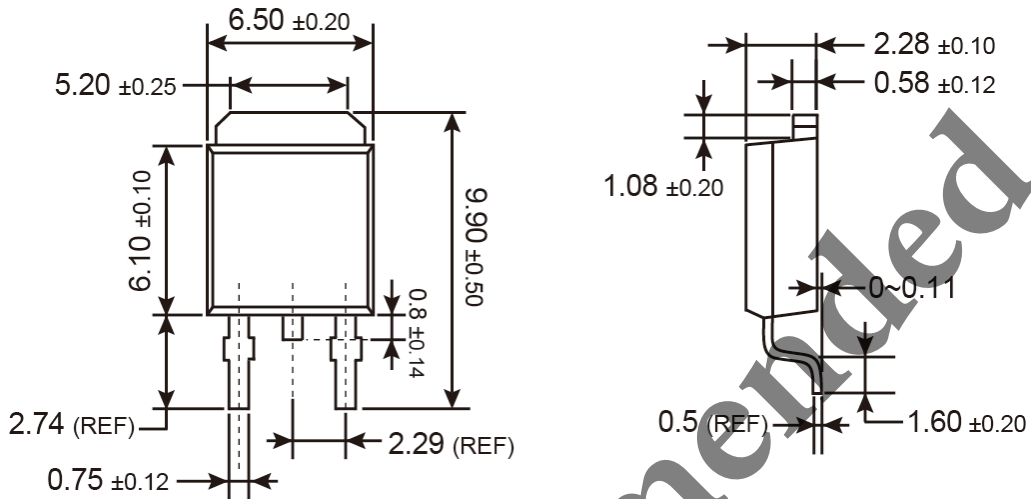

Figure 5. Bias Current vs. Output Current

TO-252 Mechanical Drawing



Unit: Millimeters

Marking Diagram

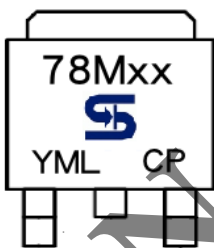

- XX** = Output Voltage
(05=5V)
- Y** = Year Code
- M** = Month Code for Halogen Free Product
 - O** =Jan
 - P** =Feb
 - Q** =Mar
 - R** =Apr
 - S** =May
 - T** =Jun
 - U** =Jul
 - V** =Aug
 - W** =Sep
 - X** =Oct
 - Y** =Nov
 - Z** =Dec
- L** = Lot Code
- CP** = Package Code for TO-252

Not Recommended

Notice

Specifications of the products displayed herein are subject to change without notice. TSC or anyone on its behalf, assumes no responsibility or liability for any errors or inaccuracies.

Information contained herein is intended to provide a product description only. No license, express or implied, to any intellectual property rights is granted by this document. Except as provided in TSC's terms and conditions of sale for such products, TSC assumes no liability whatsoever, and disclaims any express or implied warranty, relating to sale and/or use of TSC products including liability or warranties relating to fitness for a particular purpose, merchantability, or infringement of any patent, copyright, or other intellectual property right.

The products shown herein are not designed for use in medical, life-saving, or life-sustaining applications. Customers using or selling these products for use in such applications do so at their own risk and agree to fully indemnify TSC for any damages resulting from such improper use or sale.