

ARM[®] Cortex[®]-M0
32-bit Microcontroller

NuMicro[®] Family
NuTiny-SDK-NANO103
User Manual

The information described in this document is the exclusive intellectual property of Nuvoton Technology Corporation and shall not be reproduced without permission from Nuvoton.

Nuvoton is providing this document only for reference purposes of NuMicro microcontroller based system design. Nuvoton assumes no responsibility for errors or omissions.

All data and specifications are subject to change without notice.

For additional information or questions, please contact: Nuvoton Technology Corporation.

www.nuvoton.com

Table of Contents

1 OVERVIEW 4

2 NUTINY-SDK-NANO103 INTRODUCTION..... 5

2.1 NuTiny -SDK-NANO103 Jumper Description 6

2.1.1 Power Setting 6

2.1.2 Debug Connector 6

2.1.3 USB Connector 6

2.1.4 Extended Connector 6

2.1.5 Reset Button..... 6

2.1.6 Power Connector 6

2.1.7 Virtual COM Port Function Switch 6

2.2 Pin Assignment for Extended Connector 8

2.3 NuTiny-SDK-NANO103 PCB Placement 10

3 How to Start NuTiny-SDK-NANO103 on the Keil μ Vision[®] IDE 11

3.1 Keil uVision[®] IDE Software Download and Install 11

3.2 Nuvoton Nu-Link Driver Download and Install 11

3.3 Hardware Setup..... 11

3.4 Example Program..... 12

4 How to Start NuTiny-SDK-NANO103 on the IAR Embedded Workbench 13

4.1 IAR Embedded Workbench Software Download and Install 13

4.2 Nuvoton Nu-Link Driver Download and Install 13

4.3 Hardware Setup..... 13

4.4 Example Program..... 14

5 Starting to Use Nu-Link-Me 3.0 VCOM Function..... 15

5.1 Downloading and Installing VCOM Driver 15

5.2 VCOM Mode Setting on NuTiny-SDK-NANO103..... 16

5.3 Setup on the Development Tool..... 16

5.3.1 Check the Using UART on the Keil μ Vision[®] IDE..... 16

5.3.2 Check the Target Device and Debug Setting 17

5.3.3 Build and Download Code to NuTiny-SDK-NANO103..... 19

5.3.4 Open the Serial Port Terminal 19

5.3.5 Reset Chip 19

6 NuTiny-SDK-NANO103 Schematic 21

6.1 NuTiny-EVB-NANO103 Schematic 21

6.2 GPIO for 64 pin Schematic22

6.3 Nu-Link-Me V3.0 Schematic23

7 REVISION HISTORY 24

1 OVERVIEW

NuTiny-SDK-NANO103 is the specific development tool for NuMicro® NANO103 series. Users can use NuTiny-SDK-NANO103 to develop and verify the application program easily.

NuTiny-SDK-NANO103 includes two portions. One is NuTiny-EVB-NANO103 and the other is Nu-Link-Me. NuTiny-EVB-NANO103 is the evaluation board and Nu-Link-Me is its Debug Adaptor. Thus, users do not need other additional ICE or debug equipments.

2 NUTINY-SDK-NANO103 INTRODUCTION

NuTiny-SDK-NANO103 uses the NANO103SD3AE as the target microcontroller. Figure 2-1 is NuTiny-SDK-NANO103 for NANO103 series, the left portion is called NuTiny-EVB-NANO103 and the right portion is Debug Adaptor called Nu-Link-Me.

NuTiny-EVB-NANO103 is similar to other development boards. Users can use it to develop and verify applications to emulate the real behavior. The on board chip covers NANO103 series features. The NuTiny-EVB-NANO103 can be a real system controller to design users' target systems.

Nu-Link-Me is a Debug Adaptor. The Nu-Link-Me Debug Adaptor connects your PC's USB port to your target system (via Serial Wired Debug Port) and allows you to program and debug embedded programs on the target hardware. The Nu-Link-Me V3.0 also supports VCOM function, which gives users more flexibility when debug. To use Nu-Link-Me Debug adaptor with IAR or Keil, please refer to "Nuvoton NuMicro® IAR ICE driver user manual" or Nuvoton NuMicro® Keil ICE driver user manual" in detail. These two documents will be stored in the local hard disk when the user installs each driver. To use Nu-Link-Me 3.0 VCOM function, please refer to Chapter 5.

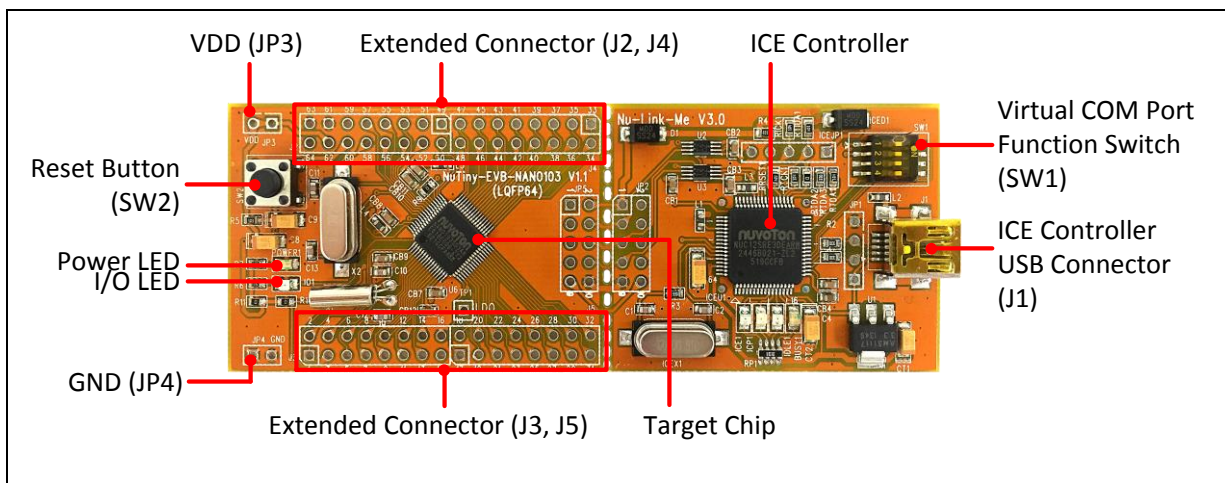

Figure 2-1 NuTiny-SDK-NANO103 (PCB Board)

2.1 NuTiny -SDK-NANO103 Jumper Description

2.1.1 Power Setting

- JP3: V_{DD} Voltage connector in NuTiny-EVB-NANO103
- J1: USB port in Nu-Link-Me

Model	JP3 V _{DD}	J1 ICE USB Port	MCU Voltage
Model 1	DC 3.3V Output	Connect to PC	DC 3.3V
Model 2	DC 1.8V ~ 3.3V Input	X	Voltage by JP3 Input

X: Unused.

2.1.2 Debug Connector

- **JP5**: Connector in target board (NuTiny-EVB-NANO103) for connecting with Nuvoton ICE adaptor (Nu-Link-Me)
- **JP2**: Connector in ICE adaptor (Nu-Link-Me) for connecting with a target board (NuTiny-EVB-NANO103)

2.1.3 USB Connector

- **J1**: Micro USB Connector in Nu-Link-Me connected to a PC USB port

2.1.4 Extended Connector

- **J2, J3, J4, and J5**: Show all chip pins in NuTiny-EVB-NANO103

2.1.5 Reset Button

- **SW2**: Reset button in NuTiny-EVB-NANO103

2.1.6 Power Connector

- **JP3**: V_{DD} connector in NuTiny-EVB-NANO103
- **JP4**: GND connector in NuTiny-EVB-NANO103

2.1.7 Virtual COM Port Function Switch

- **SW1**: Switch SW1 on/off before power on to enable/disable VCOM function. SW1 connects pin 18(PB.0/RXD) and pin 17(PB.1/TXD) in NuTiny-EVB-NANO103 with pin 22(PB.1/TXD) and pin 21(PB.0/RXD) in Nuvoton ICE adaptor (Nu-Link-Me V3.0). SW1 connects pin 30(VCOM) in Nuvoton ICE adaptor (Nu-Link-Me V3.0) to GND to enable VCOM function.

Switch Pin Number	Disable VCOM Mode	Enable VCOM Mode
1	Off	On
2	Off	On
3	Off	On
4	Off	On

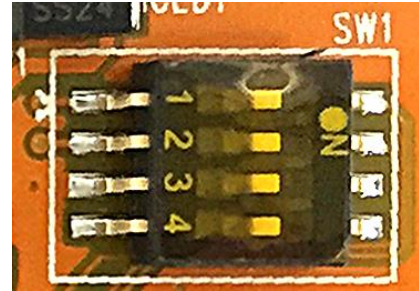

X: Unused.

2.2 Pin Assignment for Extended Connector

NuTiny-EVB-NANO103 provides NANO103SD3AE on board and the extended connector for LQFP 64-pin. Table 2-1 is the pin assignment for NANO103SD3AE.

Pin No	Pin Name	Pin No	Pin Name
01	PB.14/INT0/SPI2_MOSI1/SPI2_SS1	33	PC.11/SPI1_MOSI0/UART1_TXD
02	PB.13/SPI2_MISO1/SNOOPER	34	PC.10/SPI1_MISO0/UART1_RXD
03	VBAT	35	PC.9/SPI1_SCLK/I2C1_SCL
04	PF.6/I2C1_SDA/X32O	36	PC.8/SPI1_SS0/I2C1_SDA
05	PF.7/I2C1_SCL/SC0_CD/X32I	37	PA.15/PWM0_CH3/I2C1_SCL/TM3_CAP_IN/SC0_PWR/TM3_ECNT_IN/UART0_TXD/TM3_TOG_OUT
06	PA.11/I2C1_SCL/TM3_ECNT_IN/SC0_RST/SPI2_MOSI0/TM3_TOG_OUT	38	PA.14/PWM0_CH2/I2C1_SDA/TM2_CAP_IN/TM2_ECNT_IN/UART0_RXD/TM2_TOG_OUT
07	PA.10/I2C1_SDA/TM2_ECNT_IN/SC0_PWR/SPI2_MISO0/TM2_TOG_OUT	39	PA.13/PWM0_CH1/TM1_CAP_IN/I2C0_SCL
08	PA.9/I2C0_SCL/TM1_ECNT_IN/SC0_DAT/SPI2_SCLK/TM1_TOG_OUT/UART1_RTSn/SNOOPER	40	PA.12/PWM0_CH0/TM0_CAP_IN/I2C0_SDA
09	PA.8/I2C0_SDA/TM0_ECNT_IN/SC0_SCLK/SPI2_SS0/TM0_TOG_OUT/UART1_CTSn	41	PF.0/INT0/ICE_DAT
10	PB.4/UART1_RXD/SC0_CD/SPI2_SS0/RTC_HZ_OUT	42	PF.1/FCLKO/INT1/ICE_CLK
11	PB.5/UART1_TXD/SC0_RST/SPI2_SCLK	43	AVSS
12	PB.6/UART1_RSTn/SPI2_MISO0	44	PA.0/AD0/CMP1_P/TM2_CAP_IN/PWM0_CH2/SPI3_MOSI1
13	PB.7/UART1_CTSn/SPI2_MOSI0	45	PA.1/AD1/CMP1_N/SPI3_MISO1
14	LDO_CAP	46	PA.2/AD2/UART1_RXD
15	VDD	47	PA.3/AD3/UART1_TXD/SPI3_MOSI0
16	VSS	48	PA.4/AD4/I2C0_SDA/SPI3_MISO0
17	PB.0/UART0_RXD/SPI1_MOSI0	49	PA.5/AD5/I2C0_SCL/SPI3_SCLK
18	PB.1/UART0_TXD/SPI1_MISO0	50	PA.6/AD6/CMP1_OUT/TM3_CAP_IN/TM3_ECNT_IN/PWM0_CH3/SPI3_SS0/TM3_TOG_OUT
19	PB.2/UART0_RTSn/SPI1_SCLK/FCLKO	51	VREF
20	PB.3/UART0_CTSn/SPI1_SS0/SC1_CD	52	AVDD
21	PD.6/SPI1_MOSI1/SC1_RST	53	PC.7/UART1_TXD/AD7/TM1_CAP_IN/P

			WM0_CH1
22	PD.7/SPI1_MISO1/SC1_PWR	54	PC.6/UART1_RXD/TM0_CAP_IN/SC1_CD/PWM0_CH0
23	PD.14/SPI0_MOSI1/SC1_DAT	55	PC.15/UART1_RTSn/TM0_CAP_IN
24	PD.15/SPI0_MISO1/SC1_CLK	56	PC.14/UART1_CTSn
25	PC.3/SPI0_MOSI0/SC1_RST/PWM0_BKP0_P0	57	PB.15/INT1/SNOOPER/SC1_CD
26	PC.2/SPI0_MISO0/SC1_PWR/PWM0_BKP0_P1	58	PF.3/XT1_IN
27	PC.1/SPI0_SCLK/SC1_DAT/PWM0_BKP1_P0	59	PF.2/XT1_OUT
28	PC.0/SPI0_SS0/SC1_CLK/PWM0_BKP1_P1	60	nRESET
29	PE.5/PWM0_CH5/RTC_HZ_OUT	61	VSS
30	PB.11/PWM0_CH4/TM3_ECNT_IN/TM3_TOG_OUT/SPI0_MISO0	62	VDD
31	PB.10/SPI0_MOSI0/TM2_ECNT_IN/TM2_TOG_OUT/SPI0_SS1	63	PVSS
32	PB.9/SPI1_SS1/TM1_ECNT_IN/TM1_TOG_OUT/INT0	64	PB.8/STADC/TM0_ECNT_IN/INT0/TM0_TOG_OUT/SNOOPER

Table 2-1 Pin Assignment for NANO103

2.3 NuTiny-SDK-NANO103 PCB Placement

Users can refer to Figure 2-2 for the NuTiny-SDK-NANO103 PCB placement.

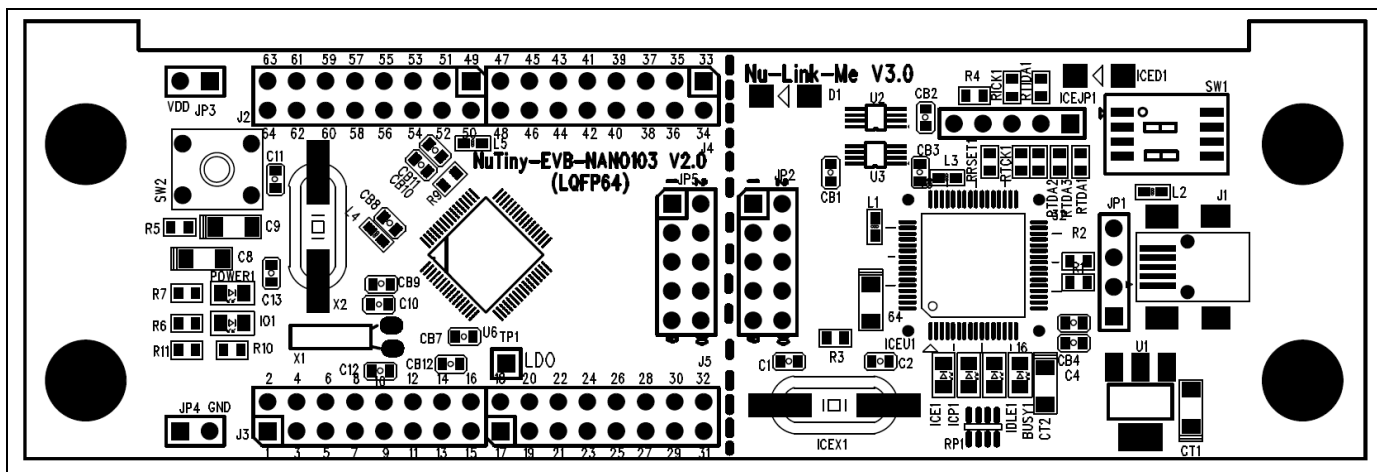

Figure 2-2 NuTiny-SDK-NANO103 PCB Placement

3 HOW TO START NUTINY-SDK-NANO103 ON THE KEIL MVISION® IDE

3.1 Keil uVision® IDE Software Download and Install

Please visit the Keil company website (<http://www.keil.com>) to download the Keil μ Vision® IDE and install the RVMDK.

3.2 Nuvoton Nu-Link Driver Download and Install

Please visit the Nuvoton company NuMicro® website (<http://www.nuvoton.com/NuMicro>) to download “NuMicro® Keil μ Vision® IDE driver” file. When the Nu-Link driver has been well downloaded, please unzip the file and execute the “Nu-Link_Keil_Driver.exe” to install the driver.

3.3 Hardware Setup

The hardware setup is shown as Figure 3-1.



Figure 3-1 NuTiny-SDK-NANO103 Hardware Setup

3.4 Example Program

This example demonstrates the ease of downloading and debugging an application on a NuTiny-SDK-NANO103 board. It can be found on Figure 3-2 list directory and downloaded from Nuvoton NuMicro® website.

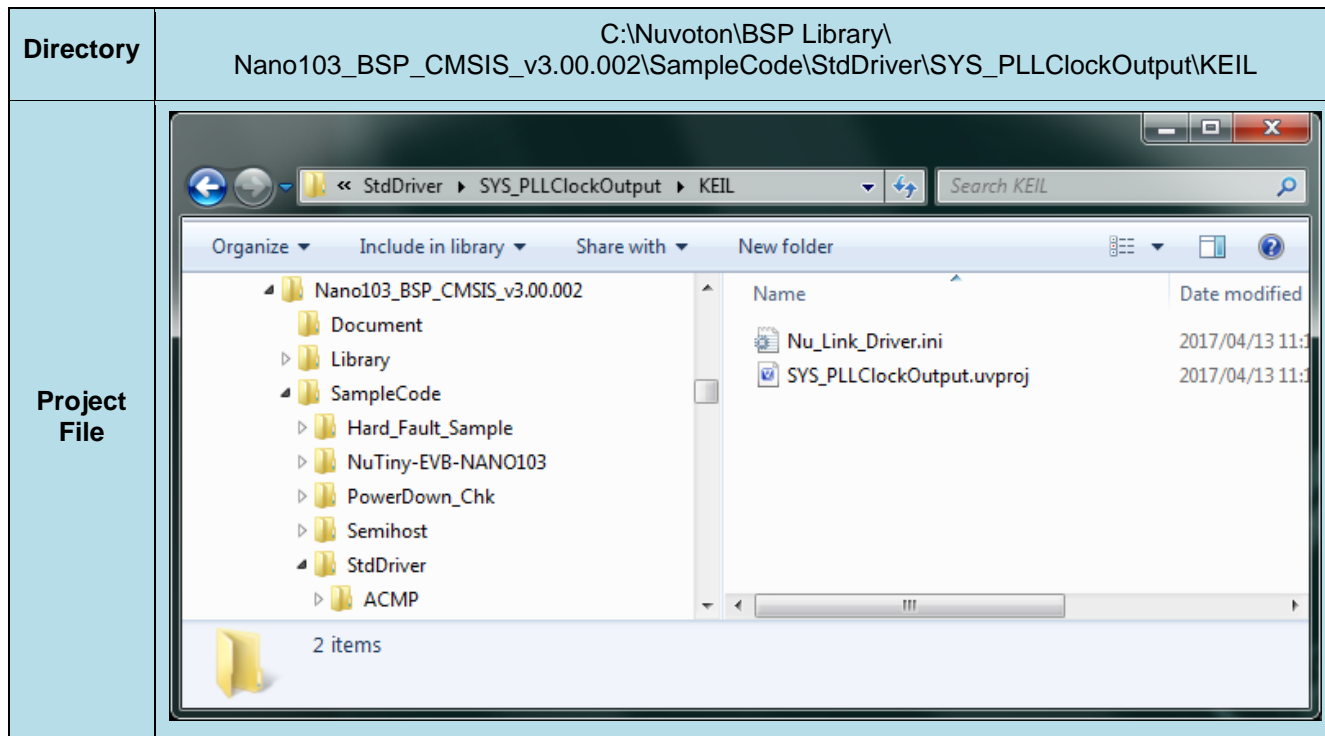









Figure 3-2 Example Directory

To use this example:

This sample code runs some functions about system manager controller and clock controller, and will show messages by Uart. Users can see the messages by following the steps of Chapter 5.

-  **Start µVision®**
- **Project-Open**
Open the SYS.uvproj project file
-  **Project - Build**
Compile and link the SYS application
-  **Flash – Download**
Program the application code into on-chip Flash ROM
-  **Start debug mode**
Using the debugger commands, you may:
 - ◆  Review variables in the watch window
 - ◆  Single step through code
 - ◆  Reset the device
 - ◆  Run the application

4 HOW TO START NUTINY-SDK-NANO103 ON THE IAR EMBEDDED WORKBENCH

4.1 IAR Embedded Workbench Software Download and Install

Please connect to IAR company website (<http://www.iar.com>) to download the IAR Embedded Workbench and install the EWARM.

4.2 Nuvoton Nu-Link Driver Download and Install

Please visit the Nuvoton company NuMicro[®] website (<http://www.nuvoton.com/NuMicro>) to download the “NuMicro[®] IAR EWARM Driver” file. When the Nu-Link driver has been well downloaded, please unzip the file and execute the “Nu-Link_Keil_Driver.exe” to install the driver.

4.3 Hardware Setup

The hardware setup is shown as Figure 4-1.

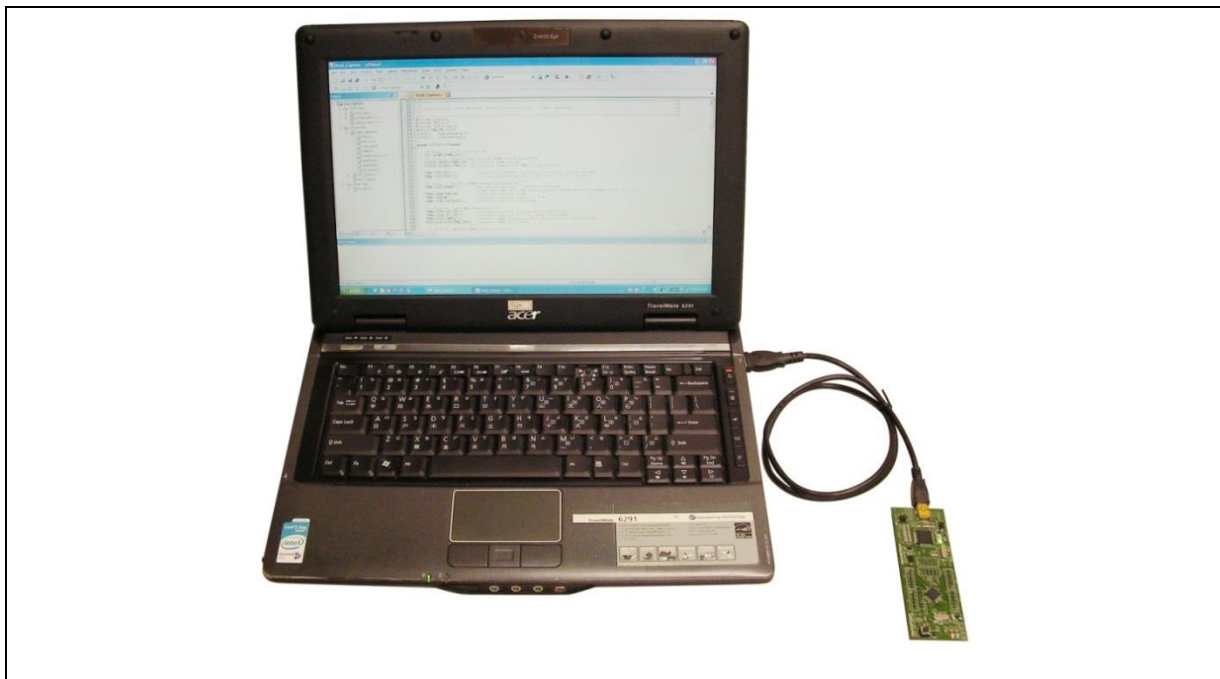

Figure 4-1 NuTiny-SDK-NANO103 Hardware Setup

4.4 Example Program

This example demonstrates the ease of downloading and debugging an application on a NuTiny-SDK-NANO103 board. It can be found on Figure 4-2 list directory and downloaded from Nuvoton NuMicro® website.

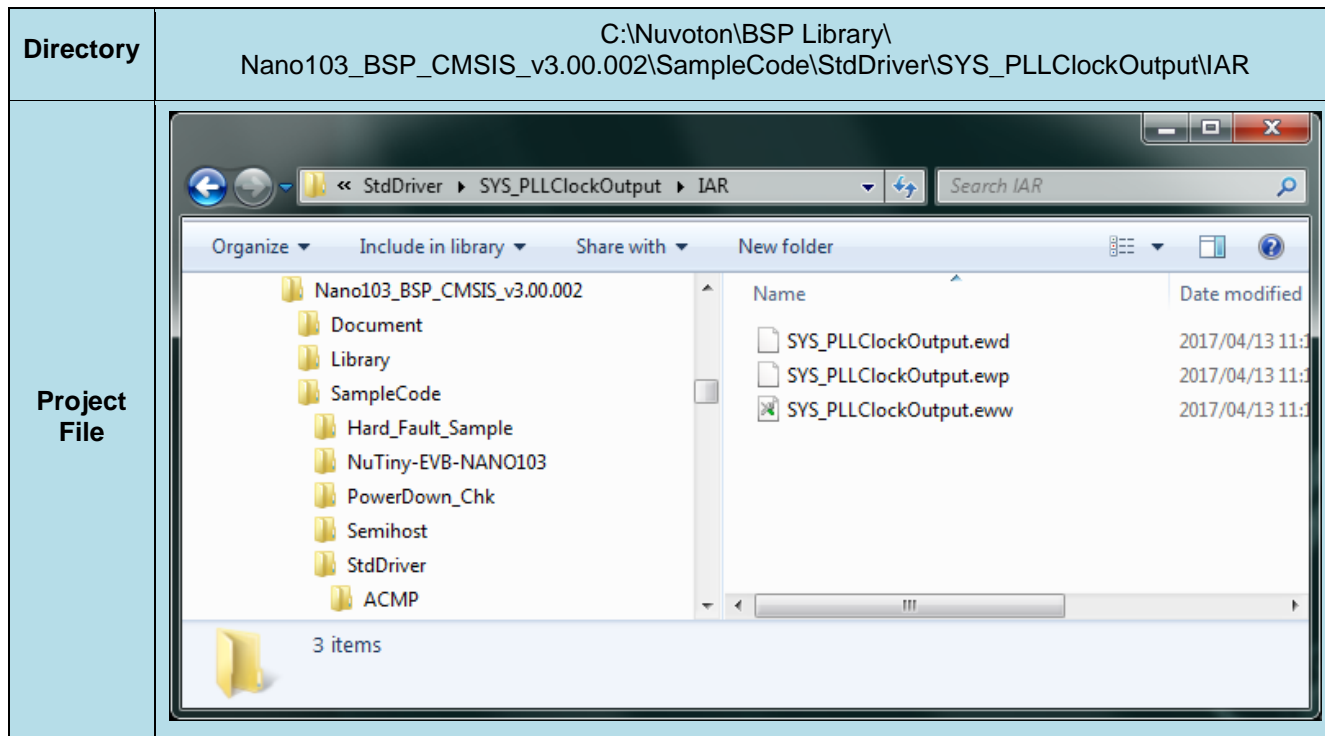







Figure 4-2 Example Directory

To use this example:

This sample code runs some functions about system manager controller and clock controller, and will show messages by Uart. Users can see the messages by following the steps of Chapter 5.

-  Start IAR Embedded Workbench
-  Project – Download and Debug
Program the application code into on-chip Flash ROM
- File-Open-Workspace
Open the SYS.eww workspace file
-  Single step through code
-  Reset the device
-  Project - Make
Compile and link the SYS application
-  Run the application

5 STARTING TO USE NU-LINK-ME 3.0 VCOM FUNCTION

5.1 Downloading and Installing VCOM Driver

Please connect to Nuvoton NuMicro® website (<http://www.nuvoton.com/NuMicro>) to download the “NuMicro® ICP Programming Tool” file. After the ICP Programming Tool driver is downloaded, please unzip the file and execute the “ICP Programming Tool.exe”. Simply follow the installation and optional steps to install ICP Programming Tool and Nu-Link USB Driver, which included VCOM driver.

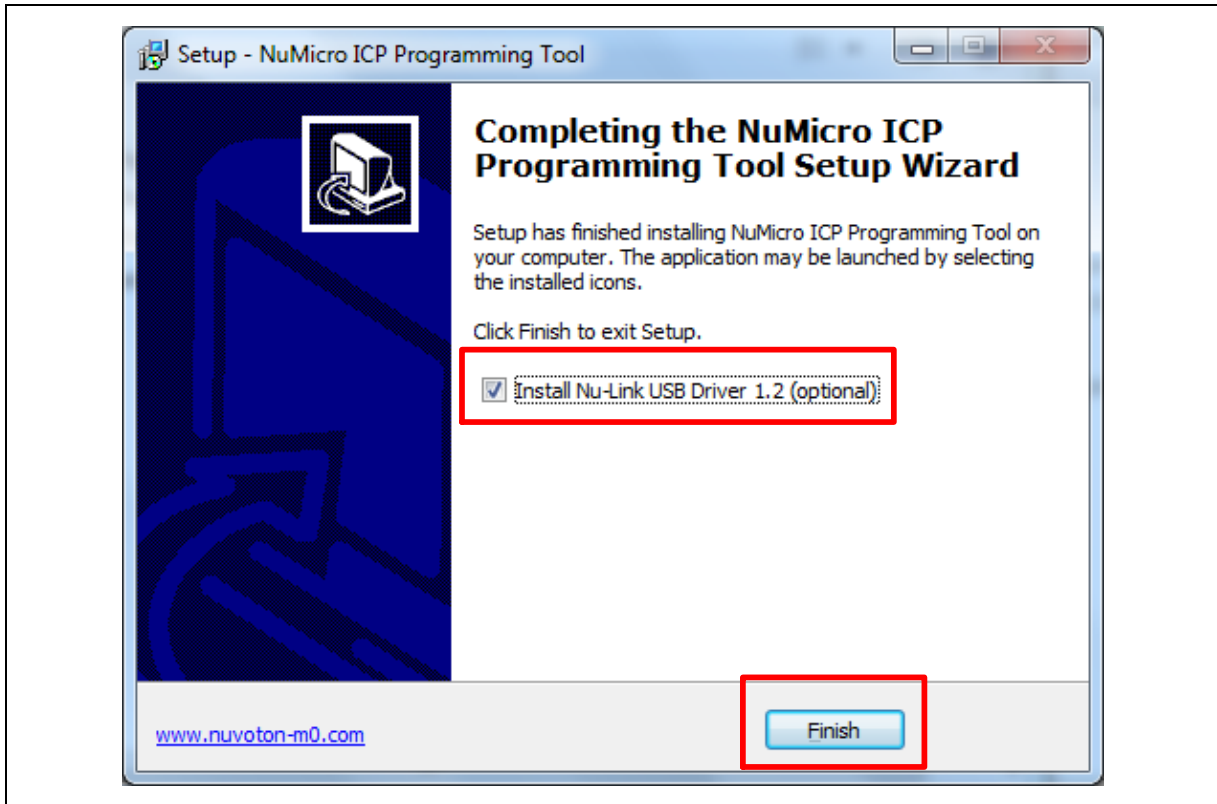

Figure 5-1 Optional Step after ICP Programming Tool Installation

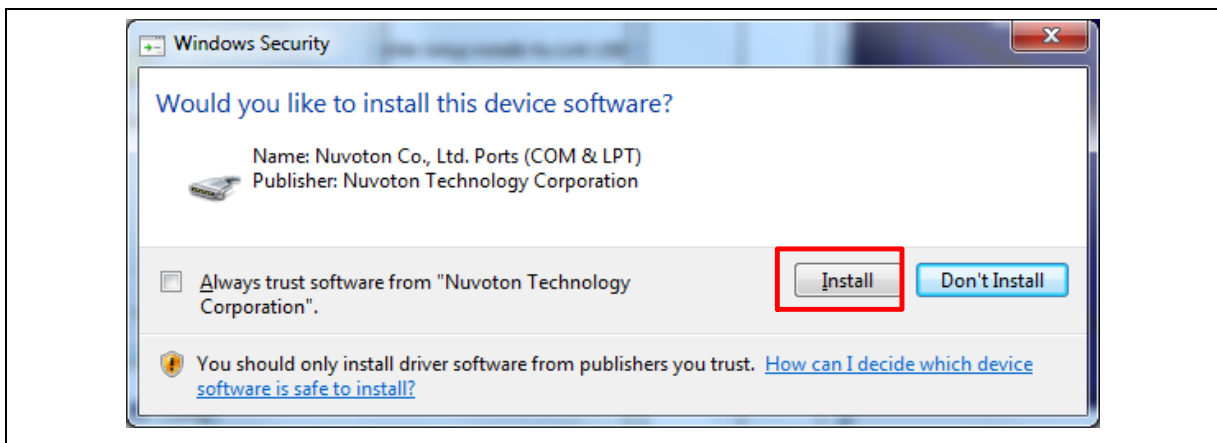

Figure 5-2 Install Nuvoton COM&LPT Driver

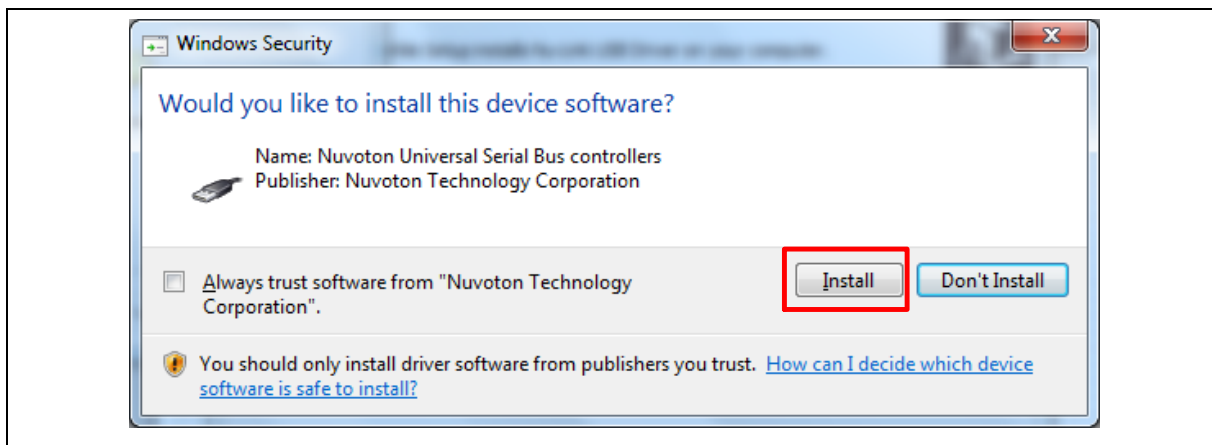

Figure 5-3 Install Nuvoton Universal Serial Bus Controllers

5.2 VCOM Mode Setting on NuTiny-SDK-NANO103

Before the NuTiny-SDK-NANO103 is connected to the PC, please enable SW1 VCOM function by switching on SW1. The NuTiny-EVB-NANO103 transmits through UART0 to VCOM to send out data. Switch SW1 off when using UART0 function without VCOM function.

After connected USB port in Nu-Link-Me to the PC, user can find a "Nuvoton Virtual Com Port" from Device Manager as Figure 5-4.

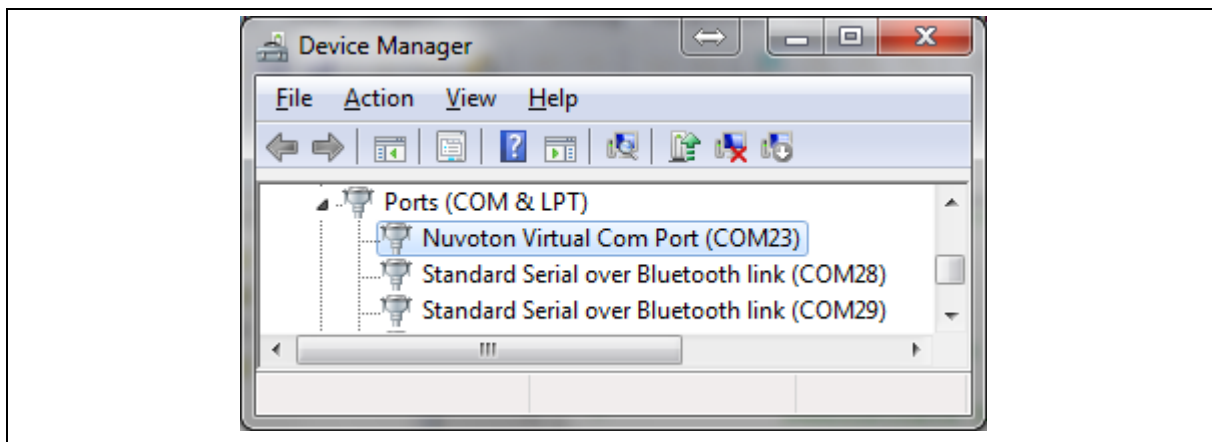

Figure 5-4 Nuvoton Virtual Com Port

5.3 Setup on the Development Tool

The example is demonstrated on the Keil μ Vision[®] IDE.

5.3.1 Check the Using UART on the Keil μ Vision[®] IDE

Please open the project and find retarget.c (which can be found in \\Nuvoton\BSP Library\Nano103_BSP_CMSIS_v3.00.002\Library\StdDriver\src\retarget.c) to check the using UART in DEBUG_PORT. The setting has to be the same as the using UART in the NuTiny-EVB-NANO103.

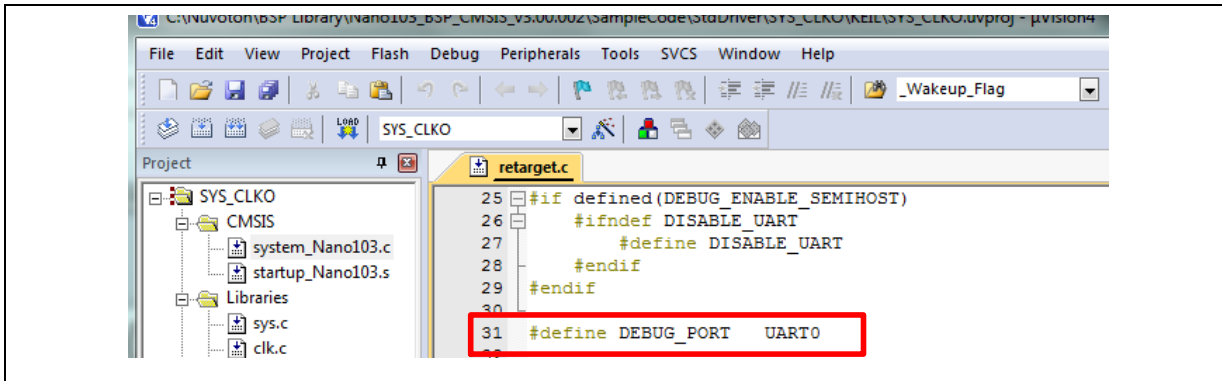
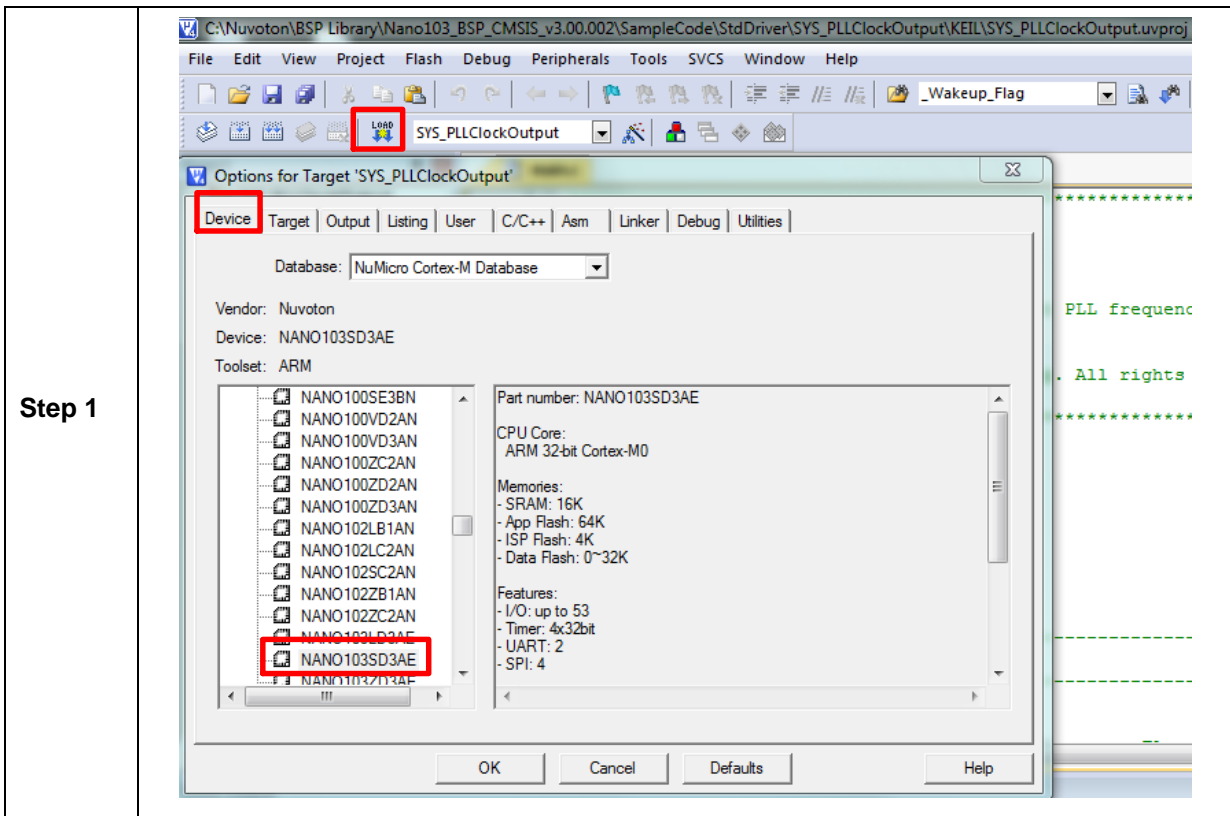

Figure 5-5 The Using UART on Keil μVision® IDE

5.3.2 Check the Target Device and Debug Setting

The target device has to be the same as the setting in Debug. Please click “Target Option” to open the Option windows, and find the setting in “Device”, “Debug”, and “Utilities” page. Please follow the steps below to check the setting.



Step 2

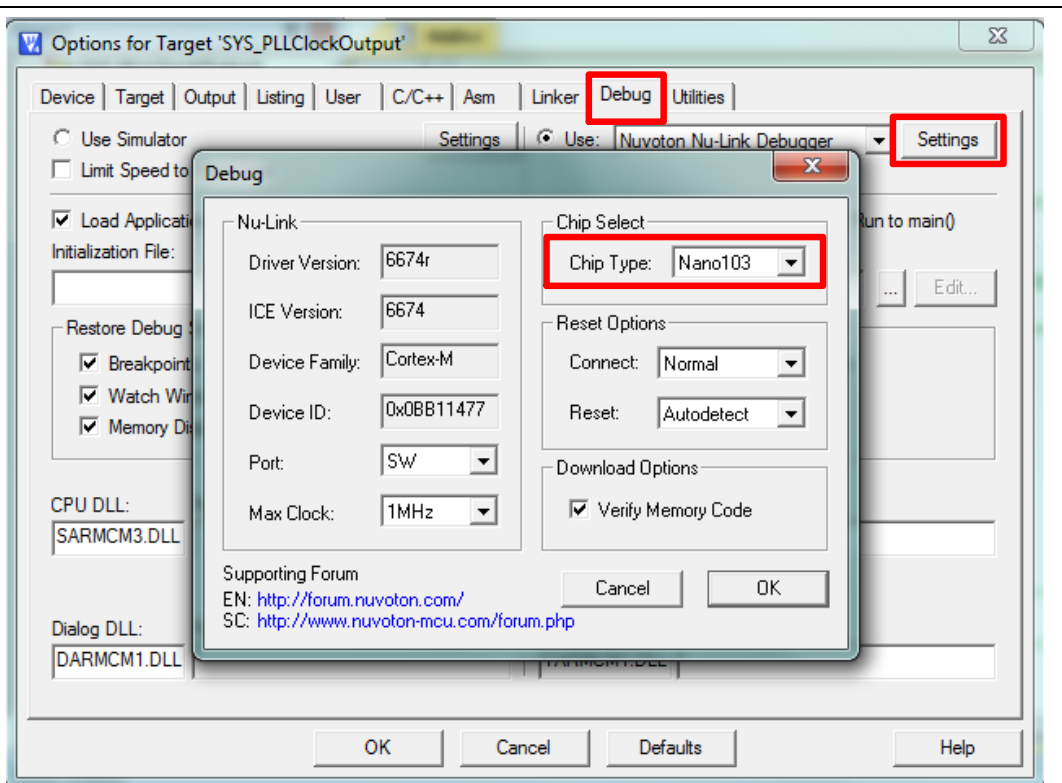

Step 3

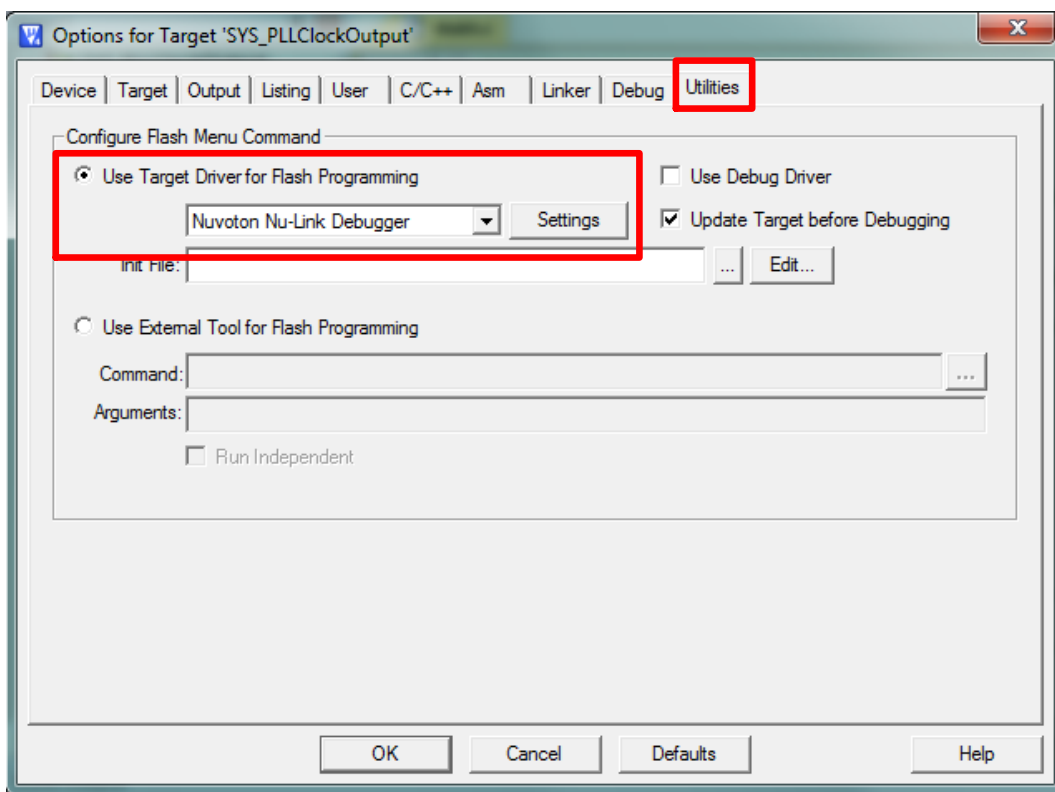

5.3.3 Build and Download Code to NuTiny-SDK-NANO103

Please build the project and download code to NuTiny-SDK-NANO103.

5.3.4 Open the Serial Port Terminal

User can use serial port terminal, PuTTY for example, to print out debug message.

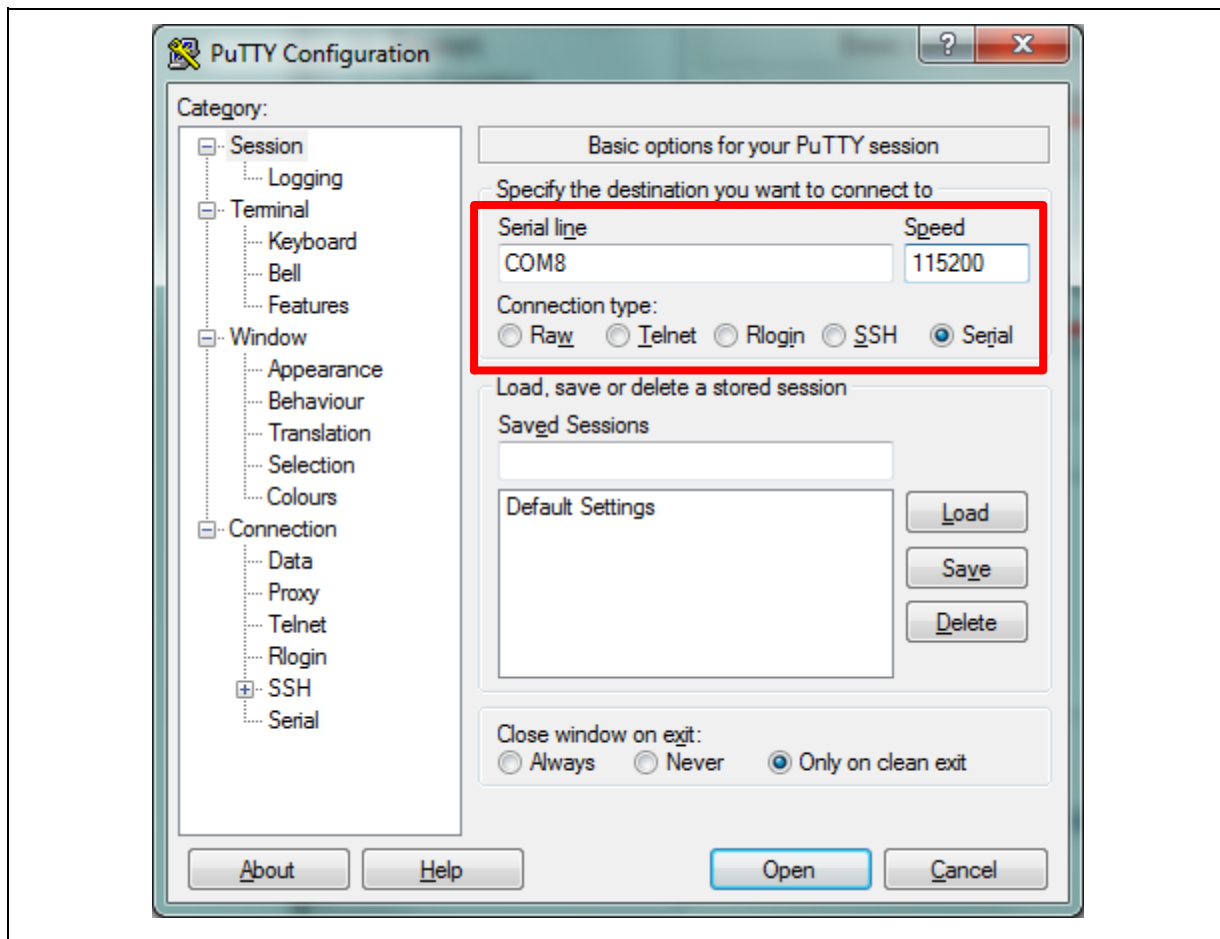

Figure 5-6 Set Baud Rate

5.3.5 Reset Chip

After pushing the reset button, the chip will reprogram application and print out debug message.

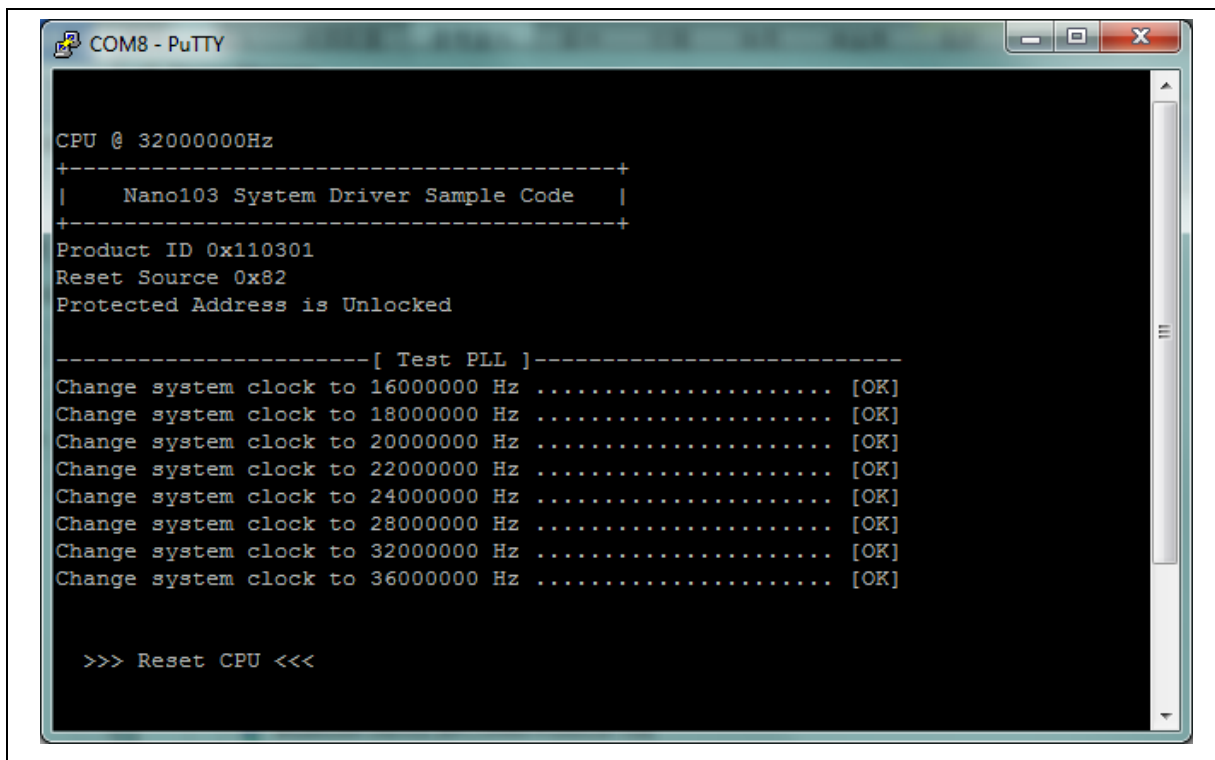
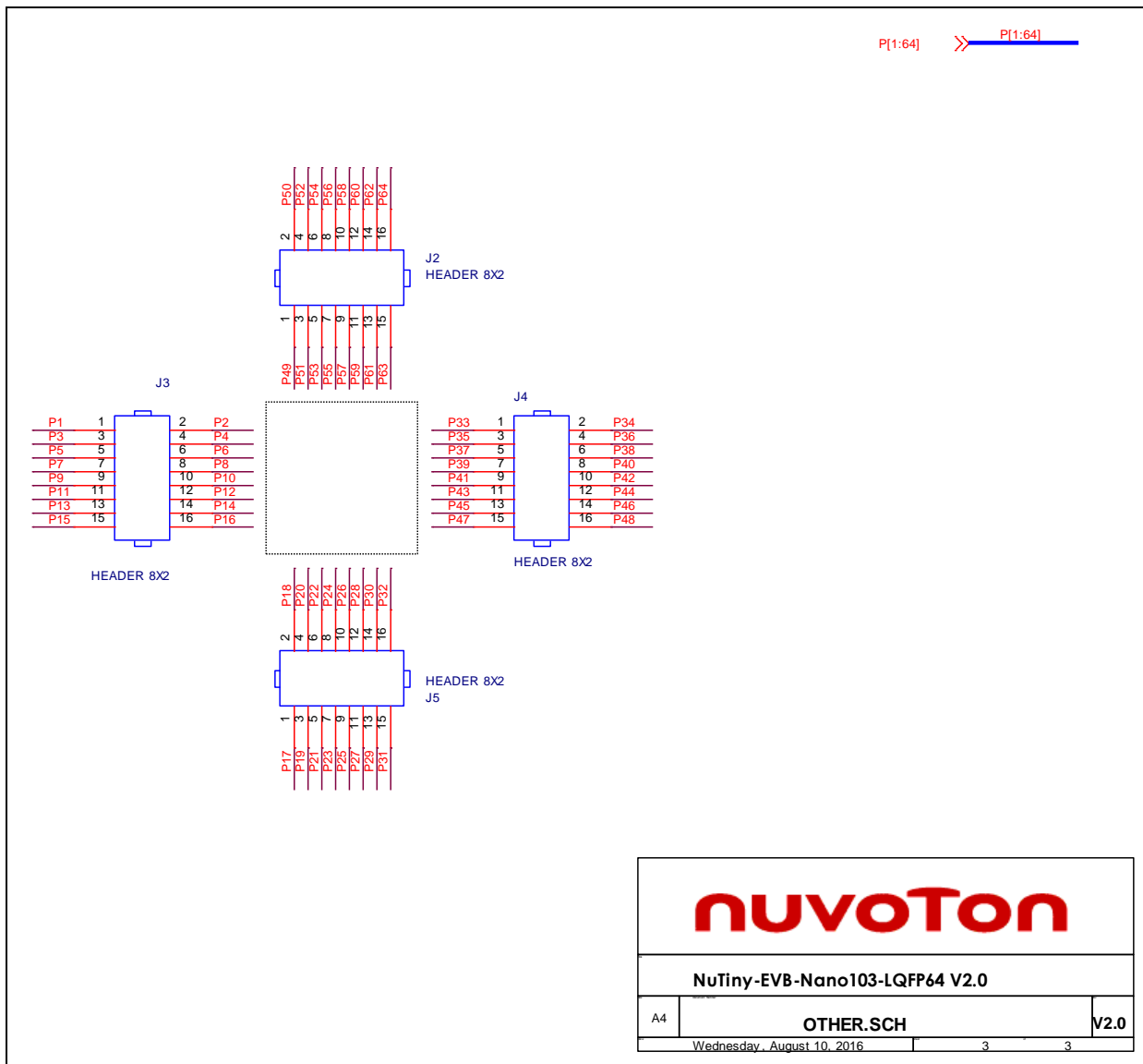

Figure 5-7 Serial Port Terminal Windows

Notice: Please switch SW1 on before the NuTiny-SDK-NANO103 connects to the PC. When the NuTiny-SDK-NANO103 connects to the PC with SW1 switch on, PC will detect VCOM as a USB device and the detection will only be processed once. VCOM will not function if switch on SW1 after the connection.

6.2 GPIO for 64 pin Schematic



6.3 Nu-Link-Me V3.0 Schematic

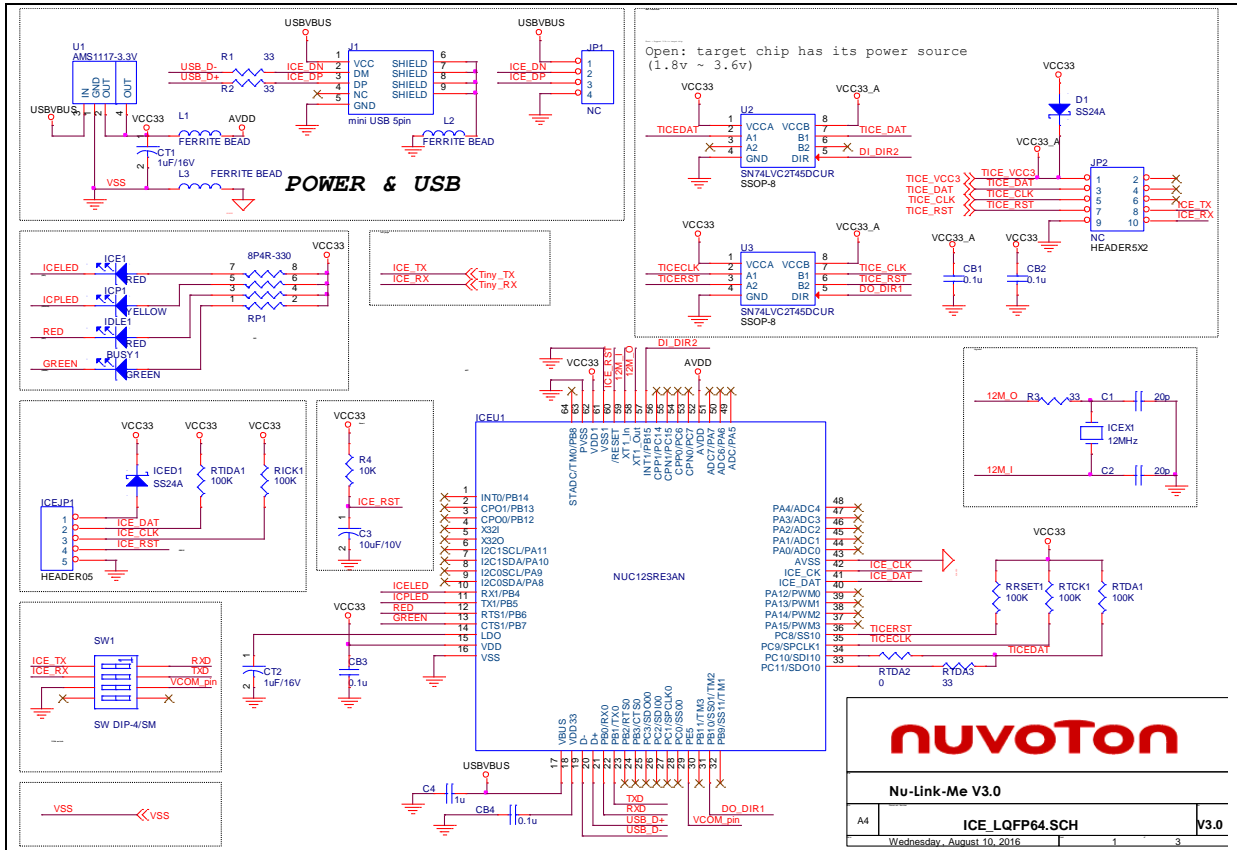

7 REVISION HISTORY

Date	Revision	Description
2018.02.26	1.00	1. Initially issued.

Important Notice

Nuvoton Products are neither intended nor warranted for usage in systems or equipment, any malfunction or failure of which may cause loss of human life, bodily injury or severe property damage. Such applications are deemed, "Insecure Usage".

Insecure usage includes, but is not limited to: equipment for surgical implementation, atomic energy control instruments, airplane or spaceship instruments, the control or operation of dynamic, brake or safety systems designed for vehicular use, traffic signal instruments, all types of safety devices, and other applications intended to support or sustain life.

All Insecure Usage shall be made at customer's risk, and in the event that third parties lay claims to Nuvoton as a result of customer's Insecure Usage, customer shall indemnify the damages and liabilities thus incurred by Nuvoton.

*Please note that all data and specifications are subject to change without notice.
All the trademarks of products and companies mentioned in this datasheet belong to their respective owners.*