

DESIGNED & DIMENSIONED IN MILLIMETERS (INCHES FOR REFERENCE)

LSS-1XX-XX-XX-DV-XX-XX

DO NOT SCALE FROM THIS PRINT

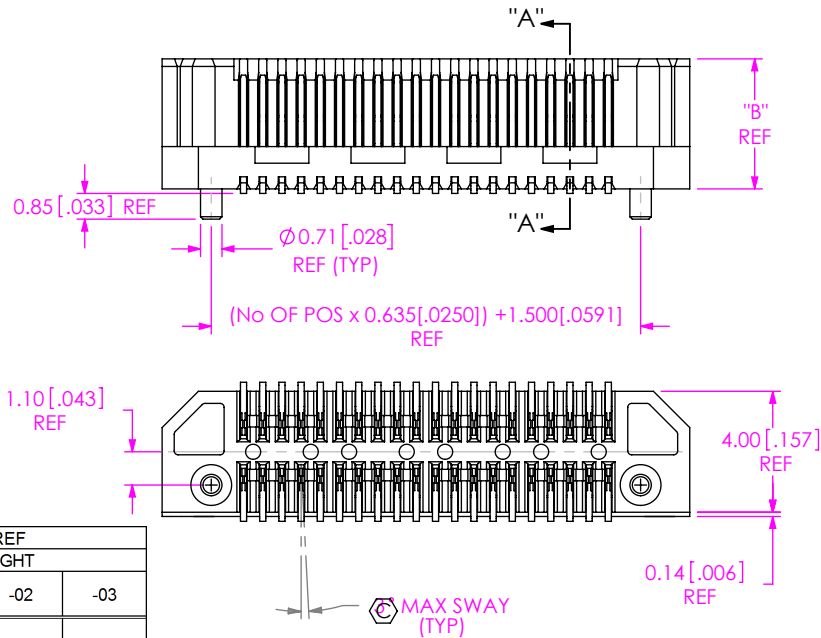
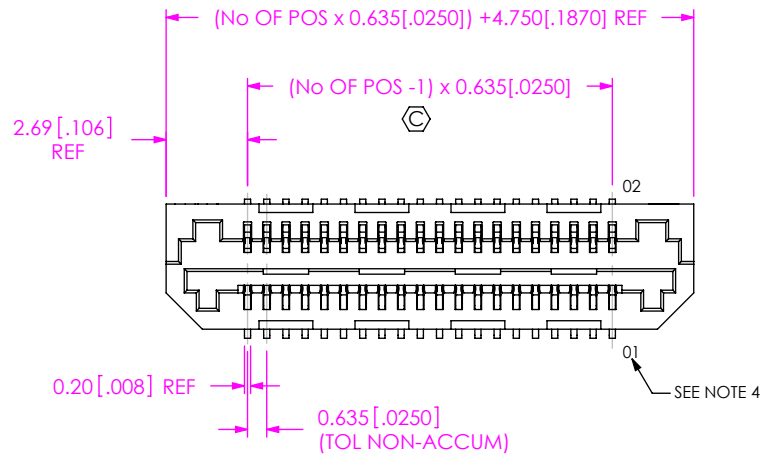

TABLE 4 REF STACK HEIGHT			
LSS LEAD STYLE	-01	-02	-03
-01	6.0MM		
-02	9.0MM	12.0MM	
-03	7.0MM	10.0MM	8.0MM

NOTES:

- ⊕ REPRESENTS A CRITICAL DIMENSION.
- BURR ALLOWANCE: .038 [.0015].
- MINIMUM PUSHOUT FORCE; TERMINALS: .5 LBS, CONTACTS: .5 LB.
- PIN 01 WILL MATE WITH CONTACT 02 ON MATING CONNECTOR.
- MEASURE FROM TOP OF VERTICAL WALL.
- MINIMUM PULL OUT FORCE FOR -LC IS .75 LB.
- FOR APPLICATIONS REQUIRING TWO OR MORE CONNECTORS PER BOARD, CONTACT IPG@SAMTEC.COM.
- TR OPTION ORDERS INVOLVING PARTIAL REEL QUANTITIES MAY BE PACKAGED ACCORDING TO THE SAMTEC PACKAGING EFFICIENCY STANDARDS (SPES) FOUND ON WWW.SAMTEC.COM.
- FR OPTIONS WILL BE SHIPPED AT THE MAX QUANTITY PER REEL, BASED ON OPTIONS SELECTED.

FIG 1
LSS-120-01-XX-DV-A SHOWN

NO. OF POSITIONS
-05, -10, 20, -30, -40, -50
(PER ROW)

LEAD STYLE
-01: 3 mm (SEE TABLE 3)
-02: 6 mm (SEE TABLE 3)
-03: 4 mm (SEE TABLE 3)

PLATING SPECIFICATION
-L: 10μ" AU IN CONTACT AREA, MATTE TIN ON TAIL (USE C-185-XX-LM)
-F: 3μ" AU IN CONTACT AREA, MATTE TIN ON TAIL (USE C-185-XX-FM)
-H: 30μ" AU IN THE CONTACT AREA, 3μ" AU ON TAIL (USE C-185-XX-H)
*-LM: 10μ" AU IN CONTACT AREA, MATTE TIN ON TAIL (USE C-185-XX-LM)
*-FM: 3μ" AU IN CONTACT AREA, MATTE TIN ON TAIL (USE C-185-XX-FM)

OPTION
-K: POLYIMIDE FILM (USE K-DOT-.138-.250-.005) (SEE FIG 2, SHT 2)
-TR: TAPE & REEL (SEE NOTE 8) (SEE FIG 4, SHT 2)
-FR: FULL REEL QTY. TAPE & REEL (SEE NOTE 9)

OPTION
-A: ALIGNMENT PIN (REQUIRED FOR -01 LEAD STYLE; OPTIONAL FOR -02 & -03)
-LC: LOCKING CLIP (-02 & -03 LEAD STYLES ONLY) (USE LC-08-TM-01) (SEE FIG 3, SHT 2) (SEE NOTE 6)

ROW SPECIFICATION
-DV: DOUBLE VERTICAL

* = FOR EXISTING CUSTOMERS ONLY

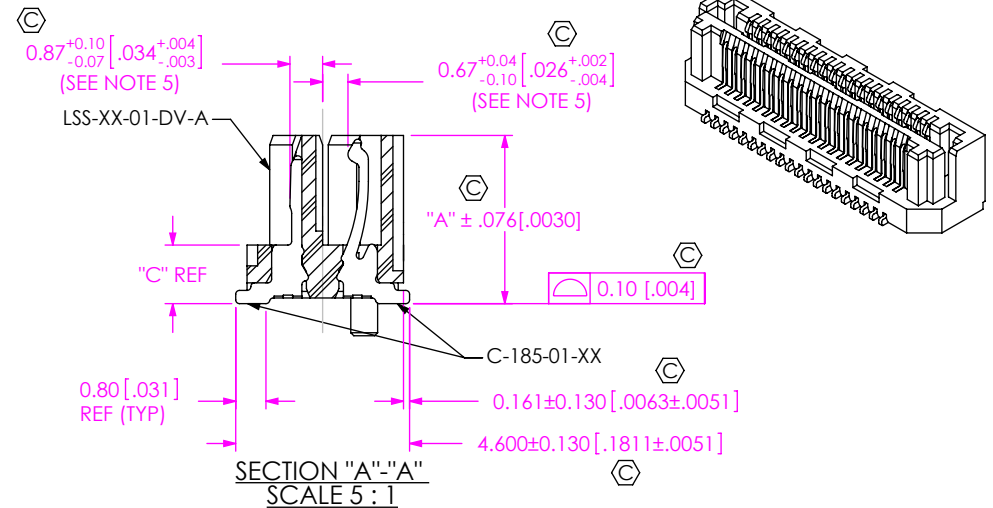

TABLE 1			
BODY HT	"A"	"B"	"C"
-01	4.450 [.1752]	4.300 [.1693]	1.596 [.0628]
-02	7.450 [.2933]	7.300 [.2874]	4.593 [.1808]
-03	5.450 [.2146]	5.300 [.2087]	2.593 [.1021]

TABLE 3		
LEADSTYLE	BODY	PIN
-01	LSS-XX-01-DV-A	C-185-01-X
-02	LSS-XX-02-DV-XX	C-185-02-X
-03	LSS-XX-03-DV-XX	C-185-03-X

UNLESS OTHERWISE SPECIFIED, DIMENSIONS ARE IN MILLIMETERS.
TOLERANCES ARE:
DECIMALS ANGLES
.X: ± .3[.01]
.XX: ±.13[.005]
.XXX: ±.051[.0020]

PROPRIETARY NOTE
THIS DOCUMENT CONTAINS CONFIDENTIAL AND PROPRIETARY INFORMATION AND ALL DESIGN, MANUFACTURING, REPRODUCTION, USE, PATENT RIGHTS AND SALES RIGHTS ARE EXPRESSLY RESERVED BY SAMTEC, INC. THIS DOCUMENT SHALL NOT BE DISCLOSED, IN WHOLE OR PART, TO ANY UNAUTHORIZED PERSON OR ENTITY NOR REPRODUCED, TRANSFERRED OR INCORPORATED IN ANY OTHER PROJECT IN ANY MANNER WITHOUT THE EXPRESS WRITTEN CONSENT OF SAMTEC, INC.

MATERIAL: DO NOT SCALE DRAWING SHEET SCALE: 4:1
INSULATOR: LCP, COLOR: BLACK
CONTACT: PHOS BRONZE

DESCRIPTION:
.635mm TERMINAL/SOCKET COMBO

samtec
520 PARK EAST BLVD, NEW ALBANY, IN 47150
PHONE: 812-944-6733 FAX: 812-948-5047
e-Mail info@SAMTEC.com code 55322

DWG. NO. LSS-1XX-XX-XX-DV-XX-XX

BY: CHAD F 07/01/2002 SHEET 1 OF 2

FIG 2
-K: POLYIMIDE FILM OPTION
(USE K-DOT-.138-.250-.005)

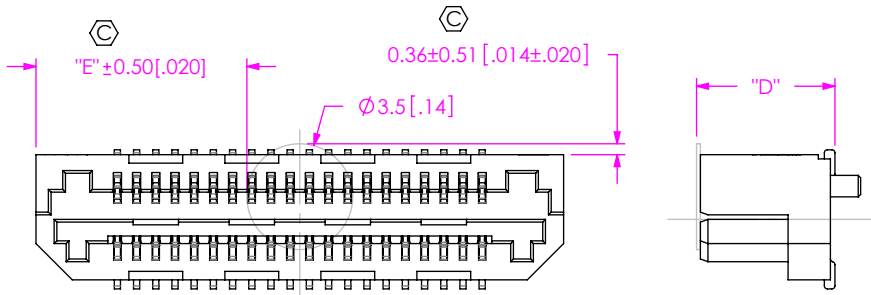

"E" = ((NO OF POS X 0.635 [.0250]) + 4.750 [.1870]) / 2 - 1.75 [.0689]

TABLE 2	
BODY HT	"D"
-01	4.58 [.180]
-02	7.58 [.298]
-03	5.58 [.220]

FIG 3
-LC: LOCKING CLIP OPTION
(USE LC-08-TM-01)
-02 & -03 LEAD STYLES ONLY
(SEE NOTE 6, SHT. 1)

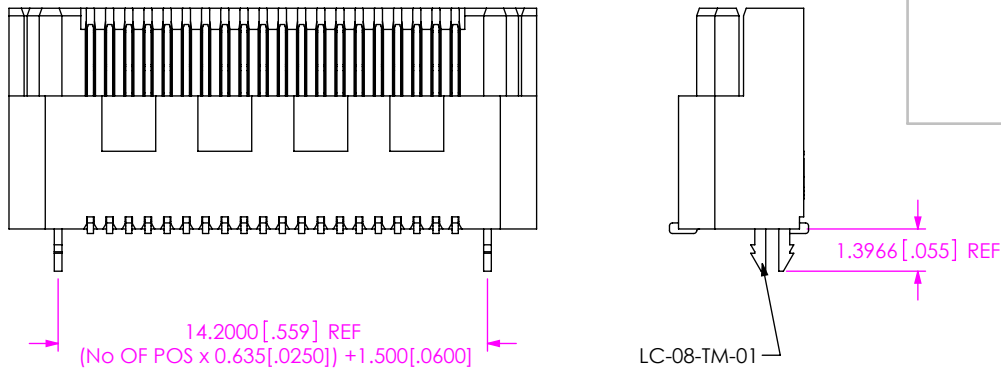
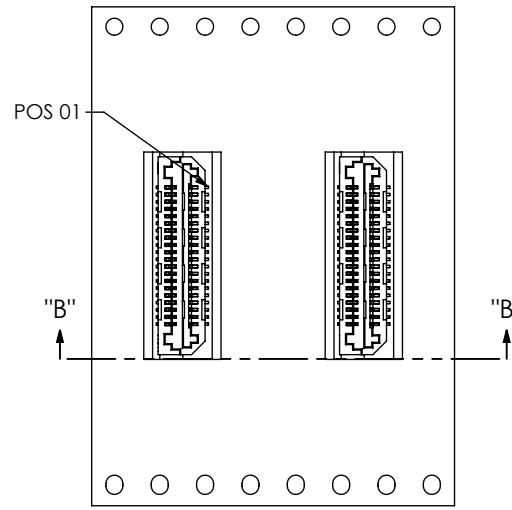
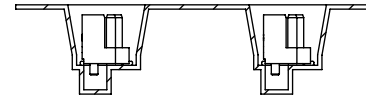

FIG 4



USER DIRECTION OF UN-REELING
POCKET NOT DETAILED →



SECTION "B"- "B"
SCALE 1.5 : 1

TAPE & REEL

LEAD STYLE	OPTION	PACKAGING TUBE	PLUG
-01	-K, -A	PT-1-24-13-09	TP-24
-02	-K, -A, -LC	PT-1-24-01-25	TP-03
-03	-K, -A, -LC	PT-1-24-11-09	TP-09

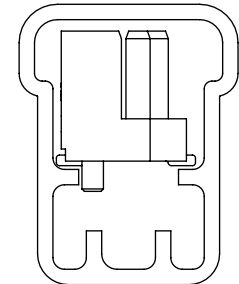

TUBE: PT-1-24-13-09
PLUG: TP-24

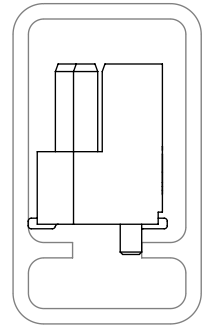
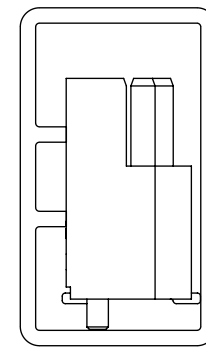

TUBE: PT-1-24-11-09
PLUG: TP-09

LOAD PARTS WITH PIN #1 IN DIRECTION OF ARROW.

PROPRIETARY NOTE
THIS DOCUMENT CONTAINS CONFIDENTIAL AND PROPRIETARY INFORMATION AND ALL DESIGN, MANUFACTURING, REPRODUCTION, USE, PATENT RIGHTS AND SALES RIGHTS ARE EXPRESSLY RESERVED BY SAMTEC, INC. THIS DOCUMENT SHALL NOT BE DISCLOSED, IN WHOLE OR PART, TO ANY UNAUTHORIZED PERSON OR ENTITY NOR REPRODUCED, TRANSFERRED OR INCORPORATED IN ANY OTHER PROJECT IN ANY MANNER WITHOUT THE EXPRESS WRITTEN CONSENT OF SAMTEC, INC.

DO NOT SCALE DRAWING

SHEET SCALE: 4:1

samtec

520 PARK EAST BLVD, NEW ALBANY, IN 47150
PHONE: 812-944-6733 FAX: 812-948-5047
e-Mail info@SAMTEC.com code 55322

DESCRIPTION:
.635mm TERMINAL/SOCKET COMBO

DWG. NO. LSS-1XX-XX-XX-DV-XX-XX

BY: CHAD F 07/01/2002 SHEET 2 OF 2