

CODING 4:1

HANDLING AREA

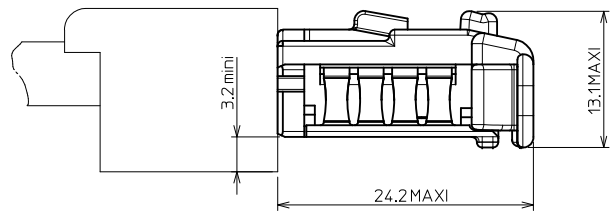
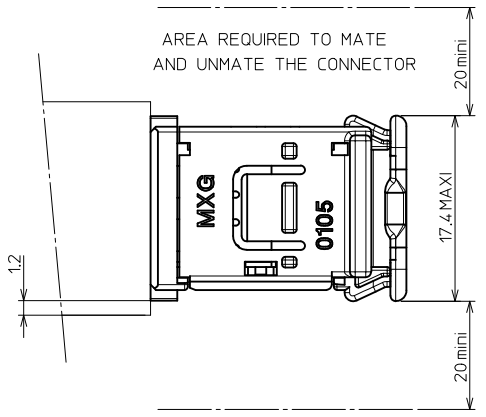

NOTE : 1 - The using conditions of the hinge are showed in the MOLEX specification n°AS-98821-001.

- 2 - Female terminal used : RCPT TERM 2.8 mm UCC2
 - Range 1 : 0988981029 (0.34 mm² to 0.68 mm²)
 - Range 2 : 0988981039 (0.93 mm² to 2.16 mm²)
 - Range 3 : 0988981049 (2.26 mm² to 4.95 mm²)

3 - Female connector will mate with male connector P/N 098824102x or header P/N 098770201x.

AREA REQUIRED WHEN THE CONNECTOR IS MATED

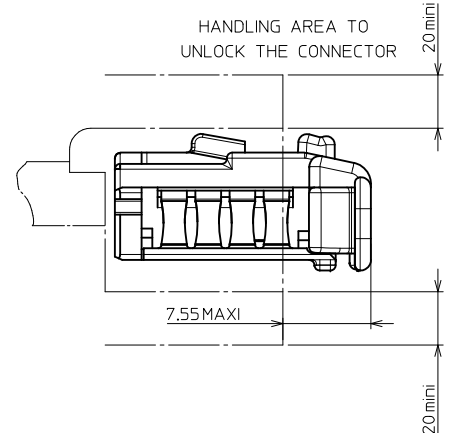

FIRST RELEASE EC NO: G2010-0051 DRAWN: LPOUCHAUD 2008/09/12 CHKC: JUCLOS 2010/07/07 APPR: OPLESSIS 2010/09/02	QUALITY SYMBOLS 	GENERAL TOLERANCES (UNLESS SPECIFIED)		DIMENSION STYLE MM ONLY	SCALE 3:1	DESIGN UNITS METRIC	THIRD ANGLE PROJECTION	
		4 PLACES ± --- ± ---	mm INCH	DRAWN BY LPOUCHAUD	DATE 2008/09/12	TITLE UCC RCPT HSG 2.8 2CKT		
		3 PLACES ± --- ± ---		CHECKED BY YIGEL	DATE 2008/09/15	MOLEX INCORPORATED		
		2 PLACES ± 0.05 ± ---		APPROVED BY JUCLOS	DATE 2008/09/17	MATERIAL NO. SEE CHART	DOCUMENT NO. SD-98819-001	SHEET NO. 1 OF 2
1 PLACE ± 0.1 ± ---		ANGULAR ± 1 °		THIS DRAWING CONTAINS INFORMATION THAT IS PROPRIETARY TO MOLEX INCORPORATED AND SHOULD NOT BE USED WITHOUT WRITTEN PERMISSION				
DRAFT WHERE APPLICABLE MUST REMAIN WITHIN DIMENSIONS								

DATUM MONTH/YEAR

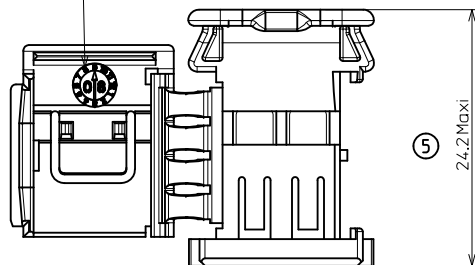

⑤ 24.2 Max

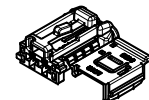
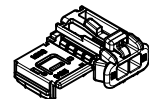

1:1

1:1

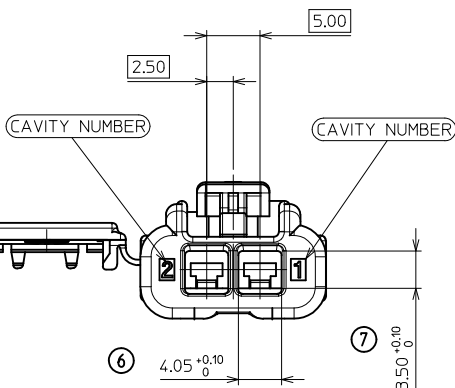

⑥

⑦

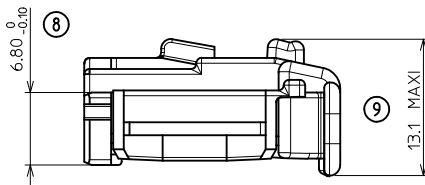

⑧

⑨

CAVITY NUMBER

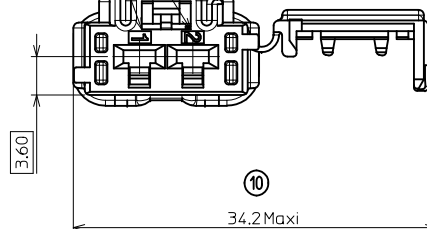

⑩

SUPPLIER ENGINEERING CONTROL ID

RAW MATERIAL

PRINT NUMBER

SUPPLIER MODIFICATION LEVEL

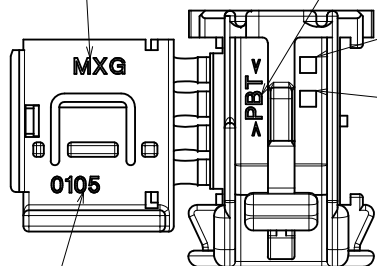

SUPPLIER PART NUMBER

GREEN CODING (P/N 0988191025) IS SHOWN.

UCC RCPT HSG 2.8 2CKT		0988191025	Green	POLYESTER (PBT)	2.131 g			
		0988191021	Black					
		0988191020	White					
Description		Part-Number	Color	Raw Material	Weight effective			
FIRST RELEASE EC NO: G2010-0051 DRAWN: LPOUCHAUD 2010/09/12 CHKD: JDUCLOS 2010/07/07 APPR: OPLESSIS 2010/09/02	QUALITY SYMBOLS 	GENERAL TOLERANCES (UNLESS SPECIFIED)		DIMENSION STYLE	SCALE	DESIGN UNITS	THIRD ANGLE PROJECTION	
				MM ONLY	1:1	METRIC		
		DRAWN BY LPOUCHAUD DATE 2008/09/12		TITLE UCC RCPT HSG 2.8 2CKT				
		CHECKED BY YIGEL DATE 2008/09/15						
		APPROVED BY JDUCLOS DATE 2008/09/17		MATERIAL NO. SD-98819-001				
		SEE CHART		DOCUMENT NO. 2 OF 2				
		THIS DRAWING CONTAINS INFORMATION THAT IS PROPRIETARY TO MOLEX INCORPORATED AND SHOULD NOT BE USED WITHOUT WRITTEN PERMISSION						