

TOLERANCE UNLESS OTHERWISE SPECIFIED	
.X	±0.25
.XX	±0.13
.XXX	±0.05

THIS IS A C.A.D. GENERATED DRAWING
DO NOT MAKE MANUAL REVISIONS TO MASTER.

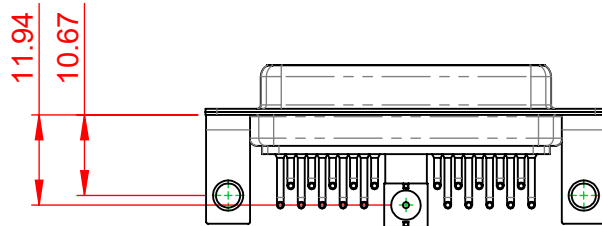

ISSUE NUMBER	
ORIGINAL	①

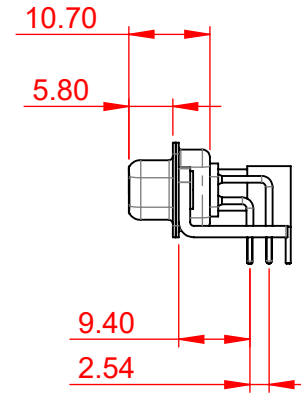
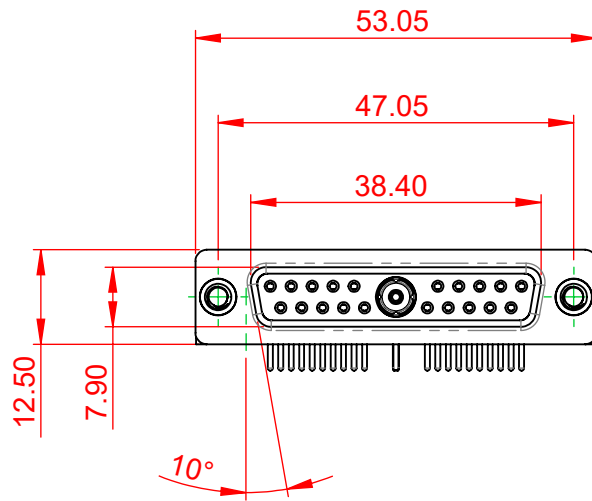

NOTES:

MATERIAL:
HOUSING: THERMOPLASTIC POLYESTER, UL94V-0
SHELL: STEEL, NICKEL PLATED
CONTACT: COPPER ALLOY, 30µ GOLD PLATED

OPERATING TEMPERATURE: -55°C ~ 125°C

POWER/CO-AX CONTACT RATING: 50Ω (IMPEDANCE)
 (IF PRESENT)
SIGNAL CONTACT CURRENT RATING: 5A PER CONTACT
SIGNAL CONTACT RESISTANCE: 10mΩ MAX.

INSULATOR RESISTANCE: 5000MΩ min.
DIELECTRIC WITHSTANDING VOLTAGE: 1000V AC rms

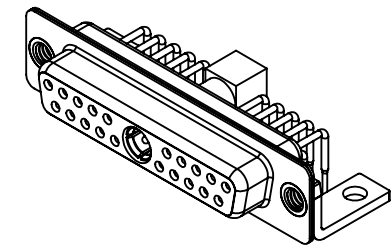

THIS SERIES FULLY CONFORMS TO
THE EUROPEAN UNION DIRECTIVES
2011/65/EU FOR RoHS COMPLIANCY.



YOUR CONNECTION TO QUALITY & SERVICE

EDAC INC
TORONTO, ONTARIO
CANADA

THESE DRAWINGS AND SPECIFICATIONS
ARE THE PROPERTY OF EDAC INC., AND
SHALL NOT BE REPRODUCED, OR COPIED
OR USED AS THE BASIS FOR THE
MANUFACTURE OR SALE OF APPARATUS
WITHOUT WRITTEN PERMISSION.

COMBINATION D-SUB

SW REFERENCE NO.: 630 COMBO ASSEMBLY	
DRAWN: C.B	DATE: JAN. 01/2019
CHECKED:	DATE:
SCALE: (IN C.A.D. 1:1)	SHEET 1 OF 2
DRAWING NUMBER: 630-21W1640-5NC	ISSUE
PART NUMBER: 630-21W1640-5NC	1

TOLERANCE UNLESS OTHERWISE SPECIFIED	
.X	±0.25
.XX	±0.13
.XXX	±0.05

THIS IS A C.A.D. GENERATED DRAWING
DO NOT MAKE MANUAL REVISIONS TO MASTER.



ISSUE NUMBER	
ORIGINAL	①



COMBINATION D-SUB		SW REFERENCE NO.: 630 COMBO ASSEMBLY	
		DRAWN: C.B	DATE: JAN. 01/2019
EDAC TORONTO, ONTARIO CANADA YOUR CONNECTION TO QUALITY & SERVICE		CHECKED:	DATE:
		SCALE: N.T.S	SHEET 2 OF 2
THESE DRAWINGS AND SPECIFICATIONS ARE THE PROPERTY OF EDAC INC., AND SHALL NOT BE REPRODUCED, OR COPIED OR USED AS THE BASIS FOR THE MANUFACTURE OR SALE OF APPARATUS WITHOUT WRITTEN PERMISSION.			DRAWING NUMBER: 630-21W1640-5NC
			PART NUMBER: 630-21W1640-5NC
			ISSUE 1



THIS SERIES FULLY CONFORMS TO
THE EUROPEAN UNION DIRECTIVES
2011/65/EU FOR RoHS COMPLIANCY.