

Data sheet | Item number: 280-502/281-604

Component terminal block; double-deck; with direct connection to DIN rail;
with P6KE91C TVS diode; 60 VDC; for DIN-rail 35 x 15 and 35 x 7.5; 2.5 mm²;
CAGE CLAMP®; 2,50 mm²; gray

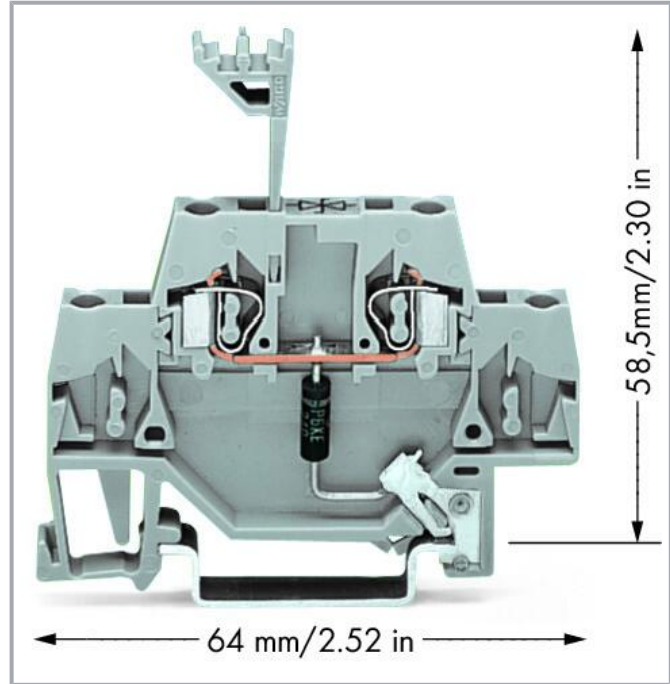

www.wago.com/280-502/281-604

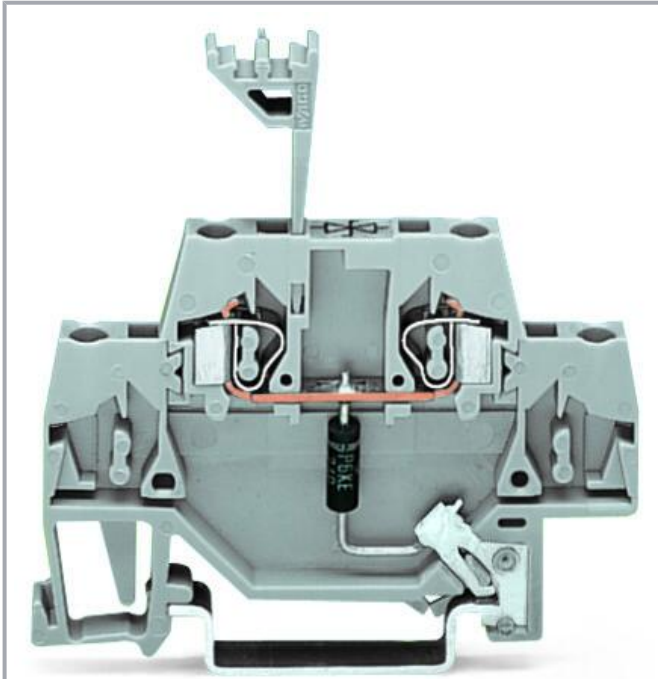

i Picture differs from the item.

Color:

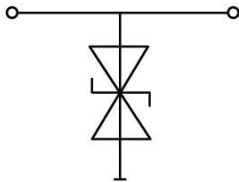

Item description

Short description:

WAGO's component terminal block with single-stage surge suppression device and direct connection to DIN-35 rail is equipped with a TVS diode.

Features:

Subject to changes. Please also observe the further product documentation!

WAGO GmbH & Co. KG
Hansastr. 27
32423 Minden
Phone: +49571 887-0 | Fax: +49571 887-169
Email: info.de@wago.com | Web: www.wago.com

Do you have any questions about our products?
We are always happy to take your call at +49 (571) 887-44222.



- Protect your system against overvoltage
- Slim, space-saving design
- Control operational costs by preventing expensive, unplanned downtime
- High operational reliability and system uptime

Data

Electrical data

Nominal operating voltage	DC 60 V
Highest continuous voltage	DC 77 V
Rated continuous current	20 A
Nominal discharge current (10/1000 µs) (line)	4.8 A
Protection level (10/1000 µs)	≤ DC 125 V
Capacitance	≤ 550 pF

Connection data

Connections (number)	2
Connection technology	CAGE CLAMP®
Solid conductor	0.08 ... 2.5 mm ² / 28 ... 14 AWG
Fine-stranded conductor	0.08 ... 2.5 mm ² / 28 ... 14 AWG
Strip length	8 ... 9 mm / 0.31 ... 0.35 inches

Physical data

Width	5 mm / 0.197 inches
Height from upper-edge of DIN-rail	58.5 mm / 2.303 inches
Depth	64 mm / 2.52 inches

Mechanical Data

Design	with direct connection to DIN-rail
Mounting type	DIN-35 rail

Material Data

Color	gray
Insulation material	Polyamide (PA66)
Material group	I
Flammability class per UL94	V0

Subject to changes. Please also observe the further product documentation!

Fire load	0.246 MJ
Weight	8.5 g

Environmental requirements

Processing temperature	-35 ... +85 °C
------------------------	----------------

Commercial data



Product Group	1 (Rail Mounted Terminal Blocks)
eCl@ss 10.0	27-14-11-27
eCl@ss 9.0	27-14-11-27
ETIM 8.0	EC000903
ETIM 7.0	EC000903
PU (SPU)	50 pcs
Packaging type	box
Country of origin	DE
GTIN	4017332225069
Customs tariff number	85369010000

Environmental Product Compliance

RoHS Compliance Status	Compliant, No Exemption
------------------------	-------------------------



Required accessories

End plate















End plate		
	Item no.: 280-341 End and intermediate plate; 2.5 mm thick; orange	www.wago.com/280-341
	Item no.: 280-340 End and intermediate plate; 2.5 mm thick; gray	www.wago.com/280-340

Optional accessories

Jumpers

Jumper		
	Item no.: 280-492 Jumper; 2-way; insulated; gray	www.wago.com/280-492
	Item no.: 280-482 Jumper; 2-way; insulated; gray	www.wago.com/280-482

Subject to changes. Please also observe the further product documentation!

	Item no.: 280-484 Jumper; 4-way; insulated; gray	www.wago.com/280-484
	Item no.: 280-490 Jumper; 10-way; insulated; gray	www.wago.com/280-490
	Item no.: 280-485 Jumper; 5-way; insulated; gray	www.wago.com/280-485
	Item no.: 280-483 Jumper; 3-way; insulated; gray	www.wago.com/280-483
Insulation stop		
Insulation stop		
	Item no.: 280-472 Insulation stop; 0.75 - 1 mm ² ; 5 pieces/strip; black	www.wago.com/280-472
	Item no.: 280-470 Insulation stop; 0.08 - 0.2 mm ² "s" (0.14 mm ² "f-st"); 5 pieces/strip; white	www.wago.com/280-470
	Item no.: 280-471 Insulation stop; 0.25 - 0.5 mm ² ; 5 pieces/strip; light gray	www.wago.com/280-471
Marking accessories		
Marker		
	Item no.: 2009-115 WMB-Inline; for Smart Printer; 1500 pieces on roll; stretchable 5 - 5.2 mm; plain; snap-on type; white	www.wago.com/2009-115
	Item no.: 793-501 WMB marking card; as card; not stretchable; plain; snap-on type; white	www.wago.com/793-501
	Item no.: 793-502 WMB marking card; as card; MARKED; 1 ... 10 (10x); not stretchable; Horizontal marking; snap-on type; white	www.wago.com/793-502
	Item no.: 793-503 WMB marking card; as card; MARKED; 11 ... 20 (10x); not stretchable; Horizontal marking; snap-on type; white	www.wago.com/793-503
	Item no.: 793-504 WMB marking card; as card; MARKED; 21 ... 30 (10x); not stretchable; Horizontal marking; snap-on type; white	www.wago.com/793-504
	Item no.: 793-505 WMB marking card; as card; MARKED; 31 ... 40 (10x); not stretchable; Horizontal marking; snap-on type; white	www.wago.com/793-505
	Item no.: 793-506 WMB marking card; as card; MARKED; 41 ... 50 (10x); not stretchable; Horizontal marking; snap-on type; white	www.wago.com/793-506
Tool		

Subject to changes. Please also observe the further product documentation!

Operating tool



Item no.: 210-720

Operating tool; Blade: 3.5 x 0.5 mm; with a partially insulated shaft; multicoloured

www.wago.com/210-720

Downloads

Documentation

Bid Text

280-502/281-604 X81 - Datei	2019 Feb 19	xml 3.4 kB	Download
--------------------------------	-------------	---------------	----------

280-502/281-604 doc - Datei	2015 Feb 11	doc 25.6 kB	Download
--------------------------------	-------------	----------------	----------

Additional Information

Disposal and Recycling Electrical and electronic equipment, Batteries, Packaging	V 1.1.0 2022 Aug 18	pdf 2.2 MB	Download
---	------------------------	---------------	----------

CAD/CAE-Data

CAD data

2D/3D Models 280-502/281-604	URL	Download
------------------------------	-----	----------

CAE data

EPLAN Data Portal 280-502/281-604	URL	Download
-----------------------------------	-----	----------

WSCAD Universe 280-502/281-604	URL	Download
--------------------------------	-----	----------

ZUKEN Portal 280-502/281-604	URL	Download
------------------------------	-----	----------

WSCAD Universe 280-502/281-604	URL	Download
--------------------------------	-----	----------

EPLAN Data Portal 280-502/281-604	URL	Download
-----------------------------------	-----	----------

Environmental Product Compliance

Compliance Search

Subject to changes. Please also observe the further product documentation!

WAGO GmbH & Co. KG
 Hansastr. 27
 32423 Minden
 Phone: +49571 887-0 | Fax: +49571 887-169
 Email: info.de@wago.com | Web: www.wago.com

Do you have any questions about our products?
 We are always happy to take your call at +49 (571) 887-44222.



Environmental Product Compliance 280-502/281-604

URL

Download

Component terminal block; double-deck; with direct connection to DIN rail; with P6KE91C TVS diode; 60 VDC; for DIN-rail 35 x 15 and 35 x 7.5; 2.5 mm²; CAGE CLAMP®; 2,50 mm²; gray

Installation Notes

Subject to changes. Please also observe the further product documentation!

WAGO GmbH & Co. KG

Hansastr. 27

32423 Minden

Phone: +49571 887-0 | Fax: +49571 887-169

Email: info.de@wago.com | Web: www.wago.com

Do you have any questions about our products?

We are always happy to take your call at +49 (571) 887-44222.