

THIS DRAWING IS UNPUBLISHED.

RELEASED FOR PUBLICATION

© COPYRIGHT - BY TYCO ELECTRONICS CORPORATION. ALL INTERNATIONAL RIGHTS RESERVED.

LOC	DIST	REVISIONS					
		P	LTR	DESCRIPTION	DATE	DWN	APVD
-	-	A1		ECR-17-009674	04JUL17	MG	BM

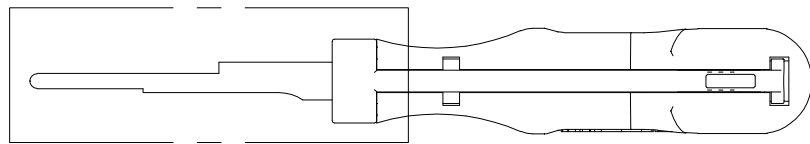
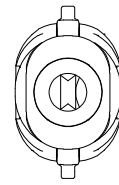
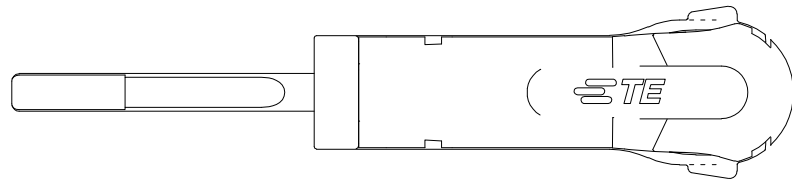

A

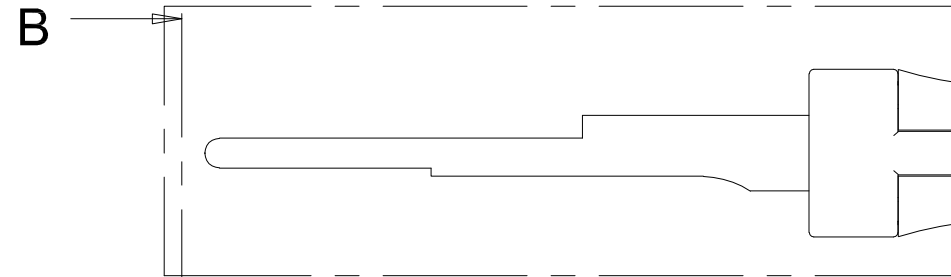

B

A
2:1



B-B
2:1

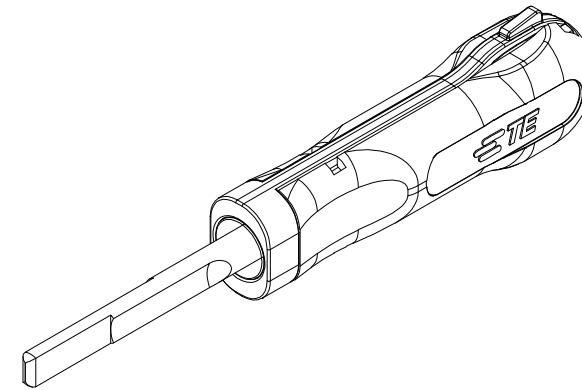
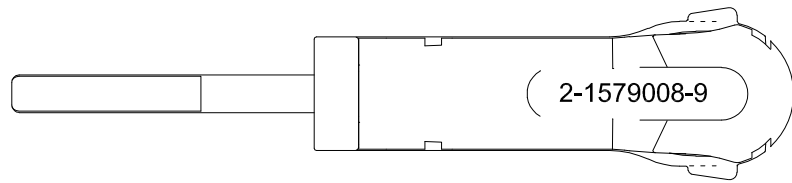

FOR CONTACTS / HOUSINGS:

8 mm MTA

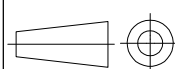
THIS DRAWING IS A CONTROLLED DOCUMENT.		DWN m.pearson CHK -	06.11.2006		 STE TE Connectivity	
DIMENSIONS: mm	TOLERANCES UNLESS OTHERWISE SPECIFIED:	APVD -	NAME			
	0 PLC ± -	PRODUCT SPEC	EXTRACTION TOOL		RESTRICTED TO	
	1 PLC ± -	APPLICATION SPEC	Entriegelungswerkzeug			
MATERIAL	FINISH	WEIGHT	SIZE	CAGE CODE	DRAWING NO	REVISIONS
		0.027 kg	A3	00779	C-2-1579008-9	1 OF 1
CUSTOMER DRAWING			SCALE	SHEET	REV	
			1:1	1 OF 1	A1	