

SFP Cage - Exploded View

1. Material full-hard tin plated brass or bronze .010" thick
2. Cage accepts all MSA Small Form-factor Pluggable adapters such as Molex patch cable assembly 73929
3. Sales Drawing Set SD-73927-001 depicts details of press-fit version of cage.
4. Sales Drawing Set SD-73927-002 depicts details of solder post version of cage.
5. Sales Drawing Set SD-73927-003 depicts details of surface mount version of cage.

ASSOCIATED PARTS	
MATERIAL NO.	DESCRIPTION
73927-0020	SFP CAGE COVER
73927-0060	SFP CAGE BASE

SD UPDATE EC NO: UDT2001-0273 DRWN: DIRKERS 2001/05/01 CHKD: DIRKERS 2001/05/02 APPR: DDOYE 2001/05/03	QUALITY SYMBOLS	GENERAL TOLERANCES (UNLESS SPECIFIED)		SCALE 3:1	DESIGN UNITS METRIC	THIRD ANGLE PROJECTION	REVISE ON CAD ONLY
	▼ = 0 ▽ = 0			DIMENSION STYLE IN/MM		TITLE SFP CAGE ASSEMBLY PCI VERSION	
		4 PLACES ± --- ± ---	3 PLACES ± --- ± .005	DRAWN BY DIRKERS	DATE 2001/01/10		
		2 PLACES ± --- ± ---	1 PLACE ± 0.13 ± ---	CHECKED BY DIRKERS	DATE 2001/01/10	MOLEX INCORPORATED MATERIAL NO. 73927-0004 DOCUMENT NO. SD-73927-004 SHEET NO. 1 OF 6	
	ANGULAR ± 1/2°		APPROVED BY RUSSELL	DATE 2001/01/10			
DRAFT WHERE APPLICABLE MUST REMAIN WITHIN DIMENSIONS		THIS DRAWING CONTAINS INFORMATION THAT IS PROPRIETARY TO MOLEX INCORPORATED AND SHOULD NOT BE USED WITHOUT WRITTEN PERMISSION					

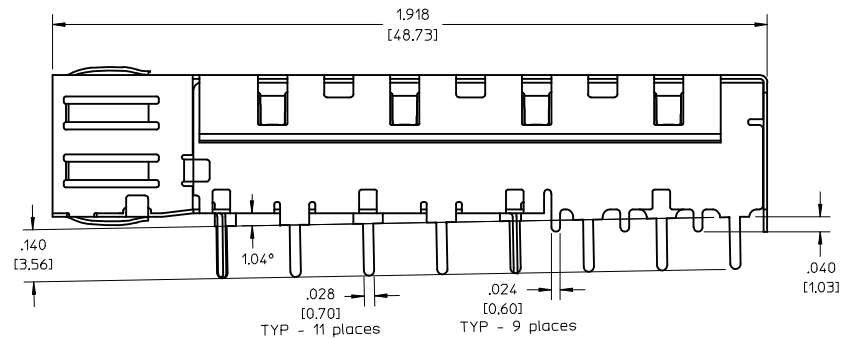
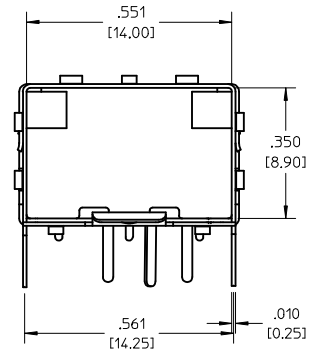
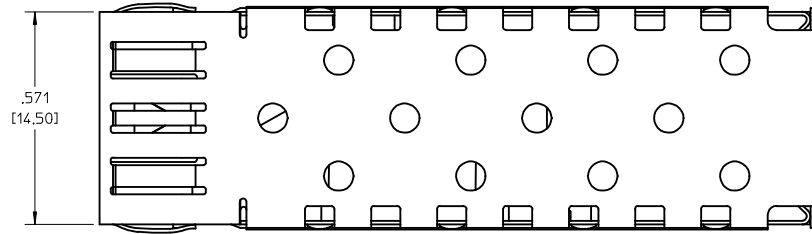
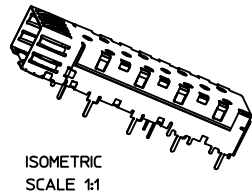

1. Dimensions of solder posts fit hole pattern and sizes per MSA guidelines.

SD UPDATE EC NO: UDT2001-0273 DRWN: DIRKERS 2001/05/01 CHKD: DIRKERS 2001/05/02 APPR: DDOYE 2001/05/03 B	QUALITY SYMBOLS ▽ = 0 ∇ = 0	GENERAL TOLERANCES (UNLESS SPECIFIED) mm INCH 4 PLACES ± --- ± --- 3 PLACES ± --- ± .005 2 PLACES ± --- ± --- 1 PLACE ± 0.13 ± --- ANGULAR ± 1/2° DRAFT WHERE APPLICABLE MUST REMAIN WITHIN DIMENSIONS	SCALE 5:1 DESIGN UNITS METRIC DIMENSION STYLE IN/MM DRAWN BY DIRKERS DATE 2001/01/10 CHECKED BY DIRKERS DATE 2001/01/10 APPROVED BY RUSSELL DATE 2001/01/10	THIRD ANGLE PROJECTION REVISE ON CAD ONLY TITLE SFP CAGE ASSEMBLY PCI VERSION MOLEX INCORPORATED MATERIAL NO. 73927-0004 DOCUMENT NO. SD-73927-004 SHEET NO. 2 OF 6
	THIS DRAWING CONTAINS INFORMATION THAT IS PROPRIETARY TO MOLEX INCORPORATED AND SHOULD NOT BE USED WITHOUT WRITTEN PERMISSION	B		

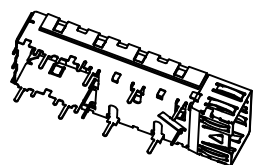
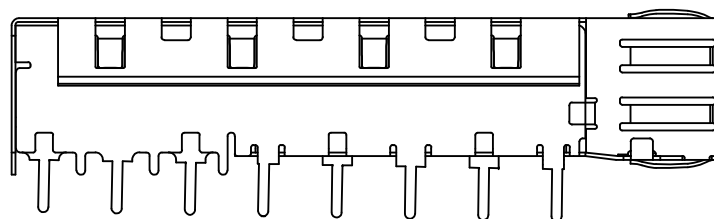
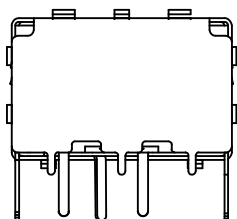

ISOMETRIC
SCALE 1:1

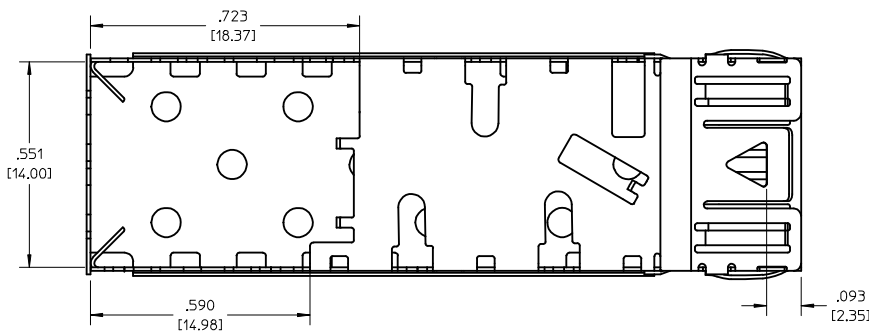

SD UPDATE EC NO: UDT2001-0273 DRWN: DIRKERS 2001/05/01 CHKD: DIRKERS 2001/05/02 APPR: DDOYE 2001/05/03	QUALITY SYMBOLS	GENERAL TOLERANCES (UNLESS SPECIFIED)		SCALE 5:1	DESIGN UNITS METRIC	THIRD ANGLE PROJECTION	REVISE ON CAD ONLY
	▼ = 0 ∇ = 0		mm	INCH	DIMENSION STYLE IN/MM		TITLE SFP CAGE ASSEMBLY PCI VERSION
		4 PLACES	± ---	± ---	DRAWN BY DIRKERS	DATE 2001/01/10	
		3 PLACES	± ---	± .005	CHECKED BY DIRKERS	DATE 2001/01/10	
2 PLACES	± ---	± ---	APPROVED BY RUSSELL		DATE 2001/01/10		
		1 PLACE	± 0.13	± ---	MATERIAL NO. 73927-0004		DOCUMENT NO. SD-73927-004
		ANGULAR ±1/2°		SHEET NO. 3 OF 6		THIS DRAWING CONTAINS INFORMATION THAT IS PROPRIETARY TO MOLEX INCORPORATED AND SHOULD NOT BE USED WITHOUT WRITTEN PERMISSION	
		DRAFT WHERE APPLICABLE MUST REMAIN WITHIN DIMENSIONS					

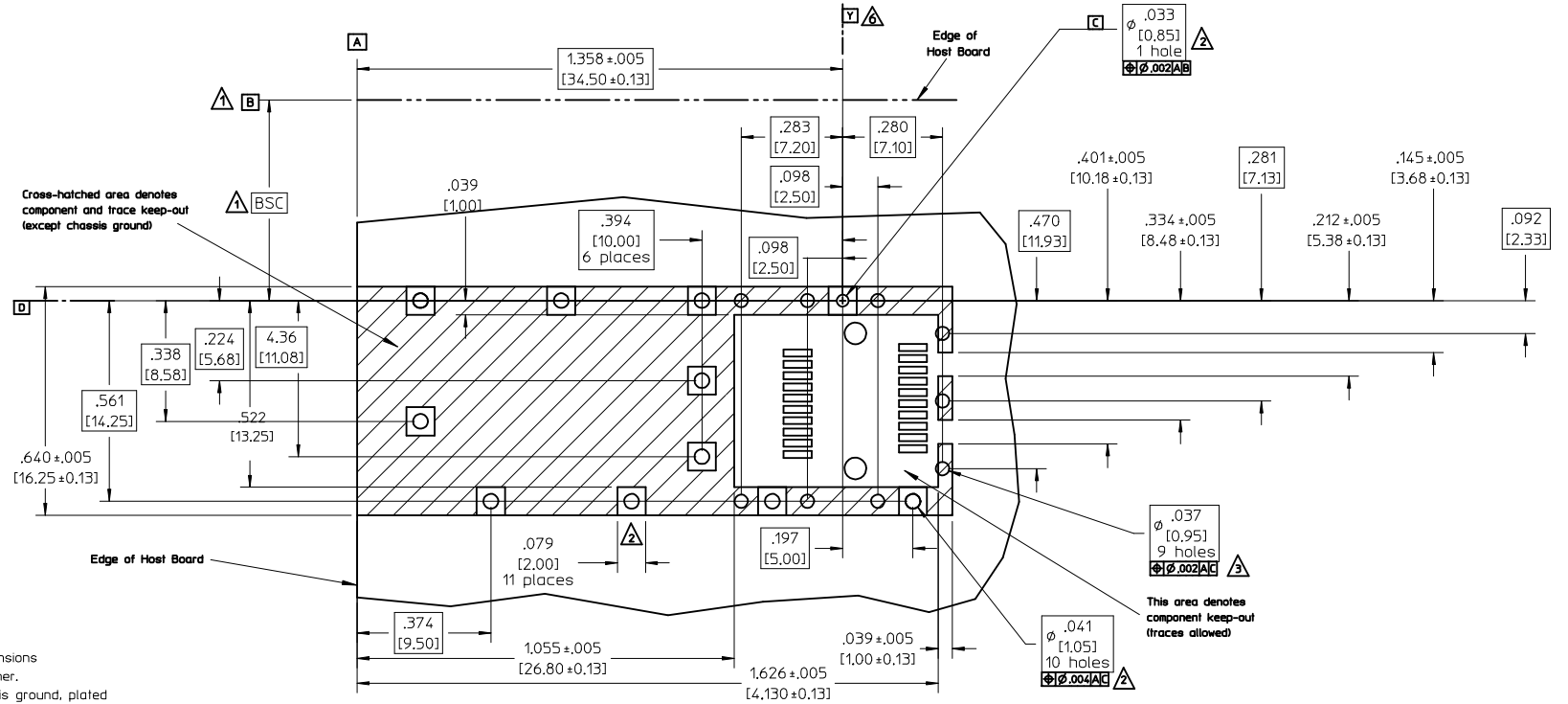

- ▲ Datum and basic dimensions established by customer.
- ▲ Vias and pads chassis ground, plated through, 11 places. Pads locations on reverse side of board if wave soldered.
- ▲ Holes optionally plated through.
- 4 Hole pattern allows two parts to be mounted "belly-to-belly" on .125" ± 5% boards. Hole layout shown for one side only. Transceiver profile outside cage determines min. board thickness in "belly-to-belly" applications.
- 5 "Belly-to-belly" mounting on boards < .118" nom. requires trimming of interior cage legs.
- ▲ Cage datum Y shown for reference to cage, only.

SD UPDATE EC NO: UDT2001-0273 DRWN: DIRKERS 2001/05/01 CHKD: DIRKERS 2001/05/02 APPR: DDOYE 2001/05/03	DESCRIPTION B	QUALITY SYMBOLS	GENERAL TOLERANCES (UNLESS SPECIFIED)	SCALE 3:1	DESIGN UNITS METRIC	THIRD ANGLE PROJECTION	REVISE ON CAD ONLY
		▼ - 0 ∇ - 0	mm INCH 4 PLACES ± --- ± --- 3 PLACES ± --- ± .005 2 PLACES ± --- ± --- 1 PLACE ± 0.13 ± --- ANGULAR ± 1/2°	DIMENSION STYLE IN/MM		TITLE SFP CAGE ASSEMBLY PCI VERSION	
		DRAFT WHERE APPLICABLE MUST REMAIN WITHIN DIMENSIONS	DRAWN BY DIRKERS CHECKED BY DIRKERS APPROVED BY RUSSELL	DATE 2001/01/10 DATE 2001/01/10 DATE 2001/01/10	MOLEX INCORPORATED MATERIAL NO. 73927-0004 DOCUMENT NO. SD-73927-004 SHEET NO. 4 OF 6		
		THIS DRAWING CONTAINS INFORMATION THAT IS PROPRIETARY TO MOLEX INCORPORATED AND SHOULD NOT BE USED WITHOUT WRITTEN PERMISSION					

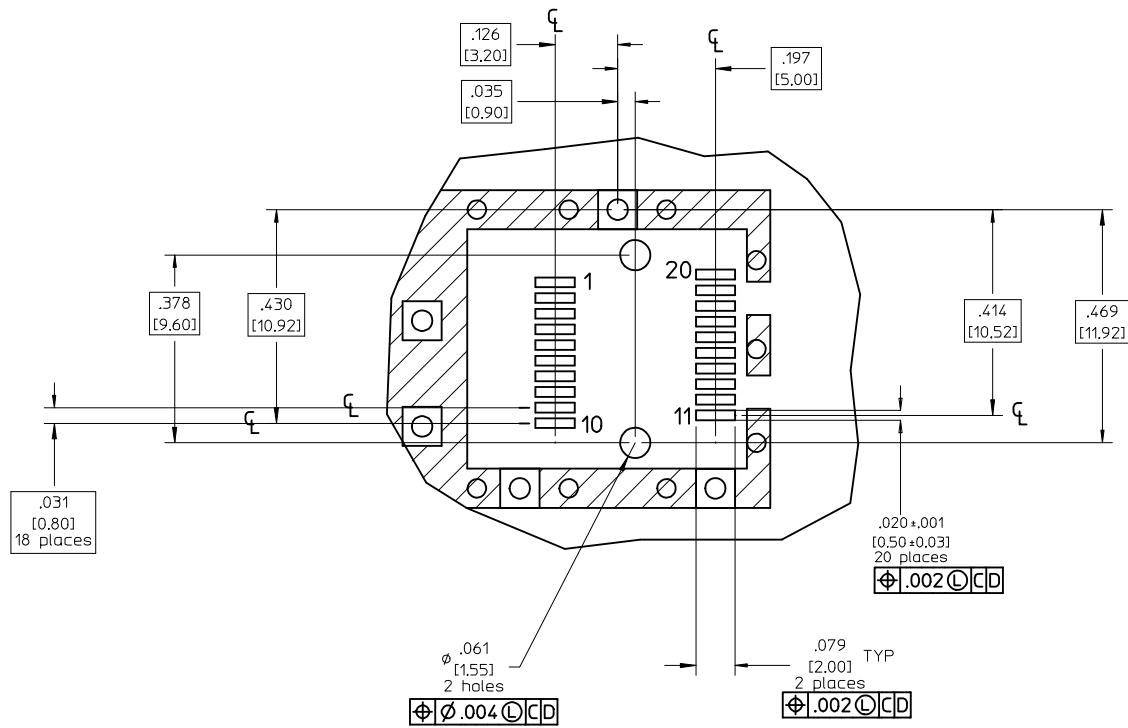

1. Connector pad pattern per MSA, will accommodate surface mount Molex connector 74441 or equivalent.

EC NO: UDT2001-0273 DRWN: DIRKERS 2001/05/01 CHKD: DIRKERS 2001/05/02 APPR: DDOYE 2001/05/03	QUALITY SYMBOLS	GENERAL TOLERANCES (UNLESS SPECIFIED)	SCALE 3:1	DESIGN UNITS METRIC	THIRD ANGLE PROJECTION	REVISE ON CAD ONLY	
	DESCRIPTION ▽ - 0 ∇ - 0	mm	INCH	DIMENSION STYLE IN/MM		SFP CAGE ASSEMBLY PCI VERSION	
		4 PLACES ± --- ± ---	3 PLACES ± --- ± .005	DRAWN BY DIRKERS	DATE 2001/01/10		
		2 PLACES ± --- ± ---	1 PLACE ± 0.13 ± ---	CHECKED BY DIRKERS	DATE 2001/01/10		
REV B	ANGULAR ± 1/2°	DRAFT WHERE APPLICABLE	APPROVED BY RUSSELL	DATE 2001/01/10	MATERIAL NO. ENTER-PART	DOCUMENT NO. SD-73927-004	
	MUST REMAIN WITHIN DIMENSIONS		THIS DRAWING CONTAINS INFORMATION THAT IS PROPRIETARY TO MOLEX INCORPORATED AND SHOULD NOT BE USED WITHOUT WRITTEN PERMISSION		SHEET NO. 5 OF 6	B	

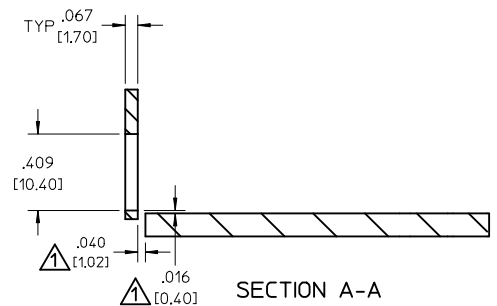
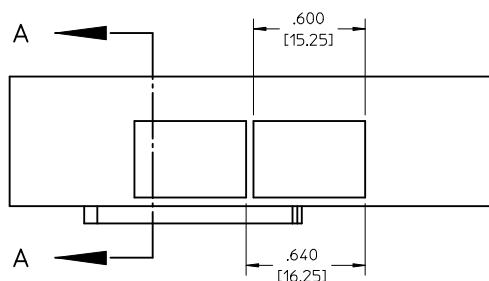
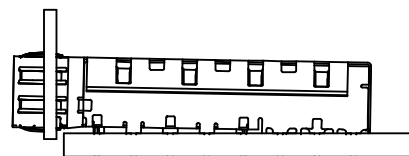
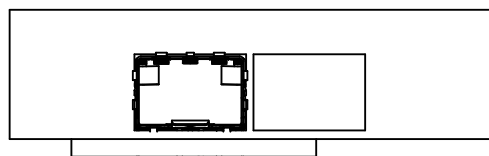

△1. Dimension to accommodate PCI application.
All others per MSA guidelines.

SD UPDATE EC NO: UDT2001-0273 DRWN: DIRKERS 2001/05/01 CHKD: DIRKERS 2001/05/02 APPR: DDOYE 2001/05/03	DESCRIPTION B	QUALITY SYMBOLS	GENERAL TOLERANCES (UNLESS SPECIFIED)		SCALE 3:1	DESIGN UNITS METRIC	THIRD ANGLE PROJECTION	REVISE ON CAD ONLY	
		▽ = 0	mm	INCH	DIMENSION STYLE IN/MM		TITLE SFP CAGE ASSEMBLY PCI VERSION		
		▽ = 0	4 PLACES ± --- ± ---	3 PLACES ± --- ± .005	DRAWN BY DIRKERS	DATE 2001/01/10	MATERIAL NO. 73927-0004		
			2 PLACES ± --- ± ---	1 PLACE ± 0.13 ± ---	CHECKED BY DIRKERS	DATE 2001/01/10	DOCUMENT NO. SD-73927-004	SHEET NO. 6 OF 6	
DRAFT WHERE APPLICABLE MUST REMAIN WITHIN DIMENSIONS			ANGULAR ± 1/2°		APPROVED BY RUSSELL	DATE 2001/01/10	THIS DRAWING CONTAINS INFORMATION THAT IS PROPRIETARY TO MOLEX INCORPORATED AND SHOULD NOT BE USED WITHOUT WRITTEN PERMISSION		