

NCV4274, NCV4274A

Regulator Family, 400 mA, 2% and 4% Voltage

Description

The NCV4274 and NCV4274A is a precision micro-power voltage regulator with an output current capability of 400 mA available in the DPAK, D2PAK and SOT-223 packages.

The output voltage is accurate within $\pm 2.0\%$ or $\pm 4.0\%$ depending on the version with a maximum dropout voltage of 0.5 V with an input up to 40 V. Low quiescent current is a feature drawing only 150 μA with a 1 mA load. This part is ideal for automotive and all battery operated microprocessor equipment.

The regulator is protected against reverse battery, short circuit, and thermal overload conditions. The device can withstand load dump transients making it suitable for use in automotive environments.

Features

- 2.5, 3.3 V, 5.0 V, 8.5 V, $\pm 2.0\%$ Output Options
- 2.5, 3.3 V, 5.0 V, $\pm 4.0\%$ Output Options
- Low 150 μA Quiescent Current at 1 mA load current
- 400 mA Output Current Capability
- Fault Protection
 - -42 V Reverse Voltage
 - Short Circuit
 - Thermal Overload
- Very Low Dropout Voltage
- NCV Prefix for Automotive and Other Applications Requiring Unique Site and Control Change Requirements; AEC-Q100 Qualified and PPAP Capable
- These are Pb-Free Devices



ON Semiconductor®

www.onsemi.com

MARKING DIAGRAMS

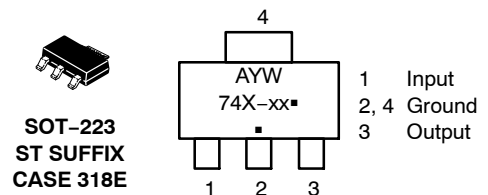
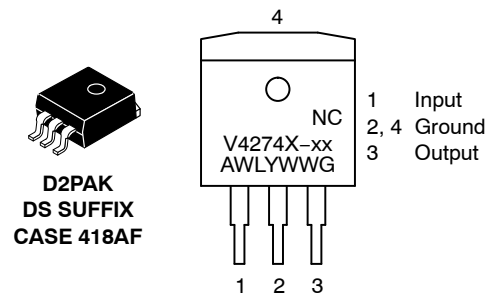
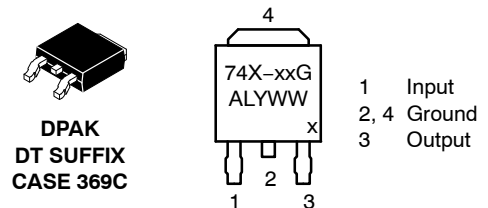

X = A or blank
xx = Voltage Ratings
A = Assembly Location
L, WL = Wafer Lot
Y = Year
WW, W = Work Week
G, ▪ = Pb-Free Package

(Note: Microdot may be in either location)

ORDERING INFORMATION

See detailed ordering and shipping information in the package dimensions section on page 15 of this data sheet.

NCV4274, NCV4274A

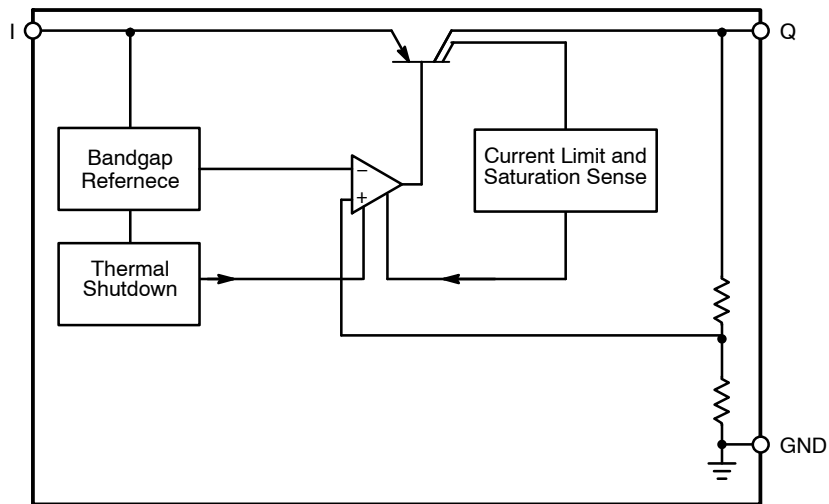

Figure 1. Block Diagram

Pin Definitions and Functions

Pin No.	Symbol	Function
1	I	Input; Bypass directly at the IC a ceramic capacitor to GND.
2,4	GND	Ground
3	Q	Output; Bypass with a capacitor to GND.

1. DPAK 3LD package code 6025
2. D2PAK 3LD package code 6083

ABSOLUTE MAXIMUM RATINGS

Pin Symbol, Parameter		Symbol	Condition	Min	Max	Unit
I, Input-to-Regulator	Voltage	V_I		-42	45	V
	Current	I_I		Internally Limited	Internally Limited	
I, Input peak Transient Voltage to Regulator with Respect to GND		V_I			60	V
Q, Regulated Output	Voltage	V_Q	$V_Q = V_I$	-1.0	40	V
	Current	I_Q		Internally Limited	Internally Limited	
GND, Ground Current		I_{GND}		-	100	mA
Junction Temperature		T_J		-	150	°C
Storage Temperature		T_{Stg}		-50	150	°C
ESD Capability, Human Body Model		ESD_{HB}		4		kV
ESD Capability, Machine Model		ESD_{MM}		200		V
ESD Capability, Charged Device Model		ESD_{CDM}		1		kV

Stresses exceeding those listed in the Maximum Ratings table may damage the device. If any of these limits are exceeded, device functionality should not be assumed, damage may occur and reliability may be affected.

3. This device series incorporates ESD protection and is tested by the following methods:
 ESD HBM tested per AEC-Q100-002 (EIA/JESD22-A114)
 ESD MM tested per AEC-Q100-003 (EIA/JESD22-A115)
 ESD CDM tested per EIA/JES D22/C101, Field Induced Charge Model

NCV4274, NCV4274A

OPERATING RANGE

Parameter	Symbol	Condition	Min	Max	Unit
Input Voltage (8.5 V Version)	V_I		9.0	40	V
Input Voltage (5.0 V Version)	V_I		5.5	40	V
Input Voltage (3.3 V, and 2.5 V Version)	V_I		4.5	40	V
Junction Temperature	T_J		-40	150	°C

THERMAL RESISTANCE

Parameter	Symbol	Condition	Min	Max	Unit
Junction-to-Ambient	DPAK R_{thja}		-	70 (Note 4)	°C/W
Junction-to-Ambient	D2PAK R_{thja}		-	60 (Note 4)	°C/W
Junction-to-Case	DPAK R_{thjc}		-	4	°C/W
Junction-to-Case	D2PAK R_{thjc}		-	3	°C/W
Junction-to-Tab	SOT-223 Ψ_{JLX} , Ψ_{LX}		-	14.5 (Note 5)	°C/W
Junction-to-Ambient	SOT-223 $R_{\theta JA}$, θ_{JA}		-	169.7 (Note 5)	°C/W

4. Soldered in, minimal footprint, FR4

5. 1 oz copper, 5 mm² copper area, FR4

LEAD FREE SOLDERING TEMPERATURE AND MSL

Parameter	Symbol	Condition	Min	Max	Unit
Lead Free Soldering, (Note 6) Reflow (SMD styles only), Pb-Free	T_{sld}	60s – 150s Above 217s 40s Max at Peak	-	265 pk	°C
Moisture Sensitivity Level	MSL	DPAK and D2PAK SOT-223	1 3	- -	

6. Per IPC/JEDEC J-STD-020C

NCV4274, NCV4274A

ELECTRICAL CHARACTERISTICS

-40°C < T_J < 150°C; V_I = 13.5 V unless otherwise noted.

Parameter	Symbol	Test Conditions	Min	Typ	Max	Min	Typ	Max	Unit
			NCV4274A			NCV4274			
REGULATOR									
Output Voltage (8.5 V Version)	V _Q	5 mA < I _Q < 200 mA 9.5 V < V _I < 40 V	8.33	8.5	8.67	-	-	-	V
Output Voltage (8.5 V Version)	V _Q	5 mA < I _Q < 400 mA 9.5 V < V _I < 28 V	8.33	8.5	8.67	-	-	-	V
Output Voltage (5.0 V Version)	V _Q	5 mA < I _Q < 400 mA 6 V < V _I < 28 V	4.9	5.0	5.1	4.8	5.0	5.2	V
Output Voltage (5.0 V Version)	V _Q	5 mA < I _Q < 200 mA 6 V < V _I < 40 V	4.9	5.0	5.1	4.8	5.0	5.2	V
Output Voltage (3.3 V Version)	V _Q	5 mA < I _Q < 400 mA 4.5 V < V _I < 28 V	3.23	3.3	3.37	3.17	3.3	3.43	V
Output Voltage (3.3 V Version)	V _Q	5 mA < I _Q < 200 mA 4.5 V < V _I < 40 V	3.23	3.3	3.37	3.17	3.3	3.43	V
Output Voltage (2.5 V Version)	V _Q	5 mA < I _Q < 400 mA 4.5 V < V _I < 28 V	2.45	2.5	2.55	2.4	2.5	2.6	V
Output Voltage (2.5 V Version)	V _Q	5 mA < I _Q < 200 mA 4.5 V < V _I < 40 V	2.45	2.5	2.55	2.4	2.5	2.6	V
Current Limit	I _Q	-	400	600	-	400	600	-	mA
Quiescent Current	I _q	I _Q = 1 mA V _Q = 8.5 V V _Q = 5.0 V V _Q = 3.3 V V _Q = 2.5 V I _Q = 250 mA V _Q = 8.5 V V _Q = 5.0 V V _Q = 3.3 V V _Q = 2.5 V I _Q = 400 mA V _Q = 8.5 V V _Q = 5.0 V V _Q = 3.3 V V _Q = 2.5 V	-	195	250	-	-	-	μA
			-	190	250	-	190	250	μA
			-	145	250	-	145	250	μA
			-	140	250	-	140	250	μA
			-	10	15	-	-	-	mA
			-	10	15	-	10	15	mA
			-	13	20	-	13	20	mA
			-	12	20	-	12	20	mA
			-	20	35	-	-	-	mA
			-	20	35	-	20	35	mA
			-	30	45	-	30	45	mA
			-	28	45	-	28	45	mA
Dropout Voltage	V _{DR}	I _Q = 250 mA, V _{DR} = V _I - V _Q							
8.5 V Version		V _I = 8.5 V	-	250	500	-	-	-	mV
5.0 V Version		V _I = 5.0 V	-	250	500	-	250	500	mV
3.3 V Version		V _I = 4.5 V	-	-	1.27	-	-	1.33	V
2.5 V Version		V _I = 4.5 V	-	-	2.05	-	-	2.1	V
Load Regulation	ΔV _Q	I _Q = 5 mA to 400 mA	-	7	20	-	7	30	mV
Line Regulation	ΔV _Q	ΔV _I = 12 V to 32 V I _Q = 5 mA	-	10	25	-	10	25	mV
Power Supply Ripple Rejection	P _{SRR}	f _r = 100 Hz, V _r = 0.5 V _{PP}	-	60	-	-	60	-	dB
Temperature output voltage drift	ΔV _Q /ΔT		-	0.5	-	-	0.5	-	mV/K
Thermal Shutdown Temperature*	T _{SD}	I _Q = 5 mA	165	-	210	165	-	210	°C

*Guaranteed by design, not tested in production

NCV4274, NCV4274A

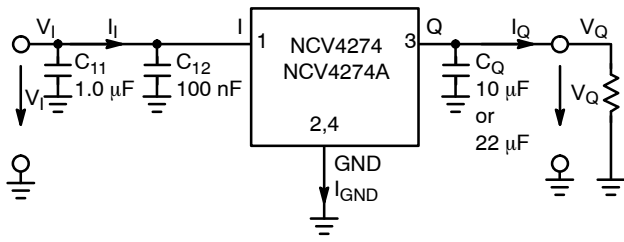

Figure 2. Measuring Circuit



Figure 3. Application Circuit

* $C_{Q} = 10 \mu\text{F}$ for $V_Q \leq 3.3 \text{ V}$
 $C_{Q} = 22 \mu\text{F}$ for $V_Q \geq 5 \text{ V}$

TYPICAL CHARACTERISTIC CURVES

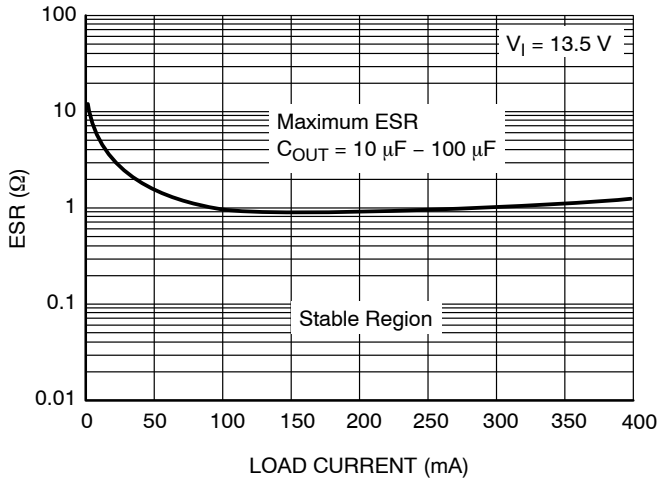

Figure 4. ESR Characterization – 3.3 V, 5 V and 8.5 V Versions

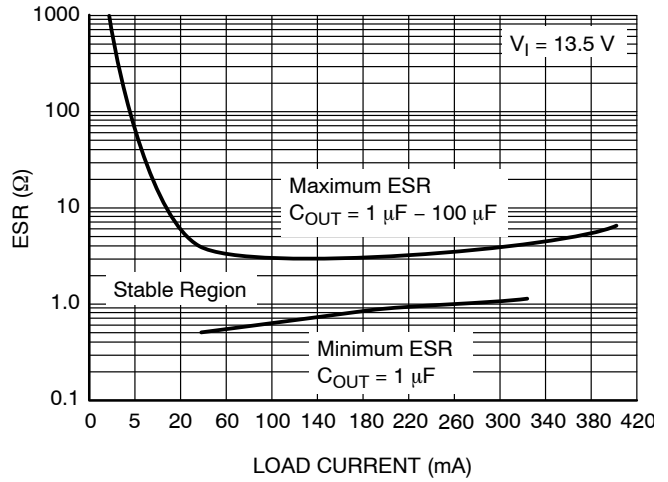

Figure 5. ESR Characterization – 2.5 V Version

NCV4274, NCV4274A

TYPICAL CHARACTERISTIC CURVES – 8.5 V Version



Figure 6. Output Voltage vs. Junction Temperature



Figure 7. Output Voltage vs. Input Voltage



Figure 8. Output Current vs. Input Voltage



Figure 9. Current Consumption vs. Output Current (High Load)

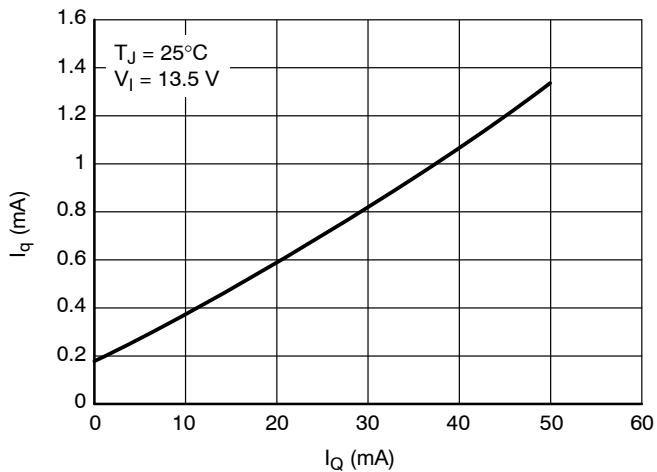

Figure 10. Current Consumption vs. Output Current (Low Load)

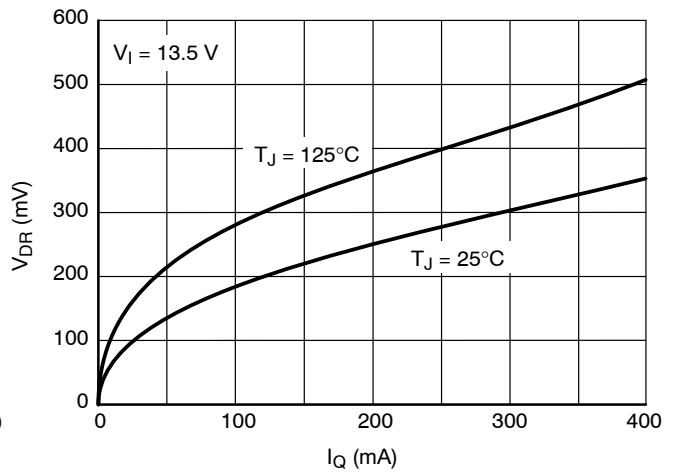

Figure 11. Drop Voltage vs. Output Current

NCV4274, NCV4274A

TYPICAL CHARACTERISTIC CURVES – 8.5 V Version

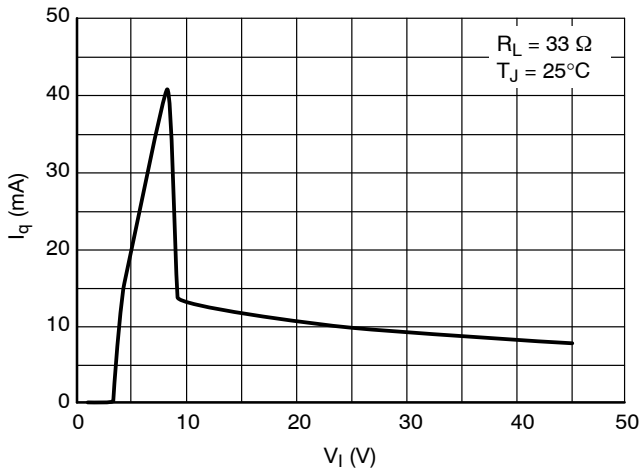

Figure 12. Current Consumption vs. Input Voltage



Figure 13. Input Current vs. Input Voltage

TYPICAL CHARACTERISTIC CURVES – 5.0 V Version



Figure 14. Output Voltage vs. Junction Temperature

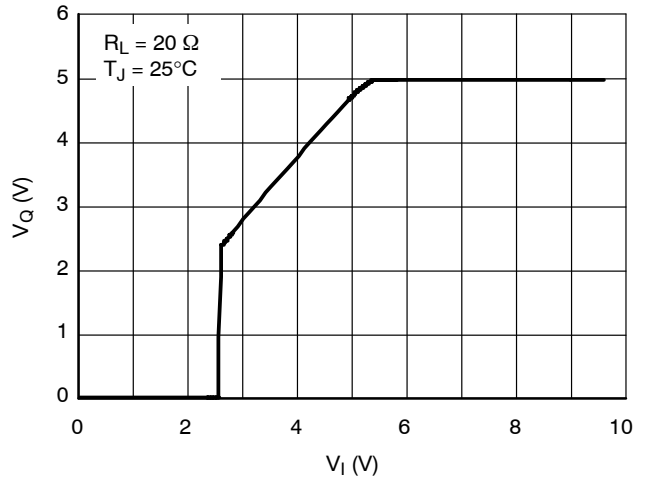

Figure 15. Output Voltage vs. Input Voltage



Figure 16. Output Current vs. Input Voltage

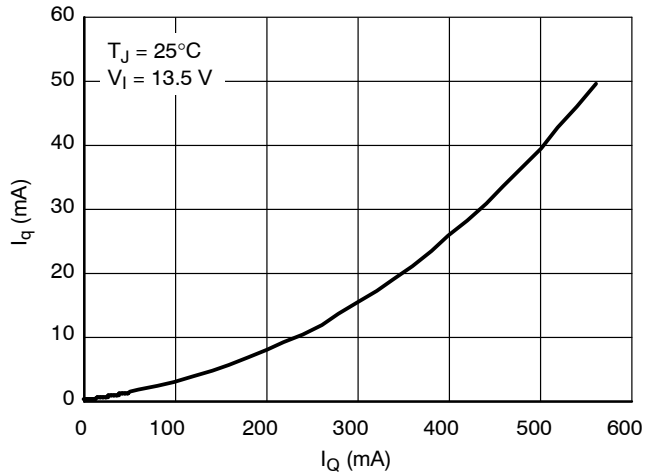

Figure 17. Current Consumption vs. Output Current (High Load)

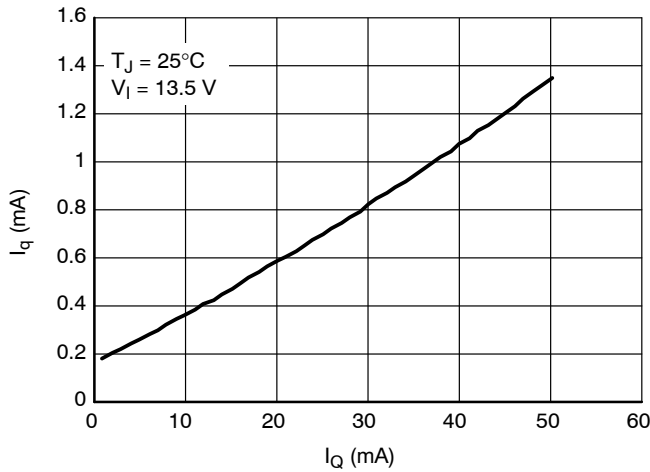

Figure 18. Current Consumption vs. Output Current (Low Load)

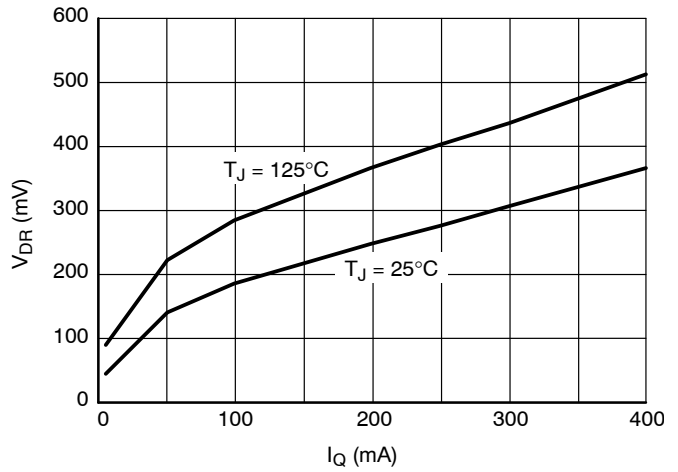

Figure 19. Drop Voltage vs. Output Current

NCV4274, NCV4274A

TYPICAL CHARACTERISTIC CURVES – 5.0 V Version

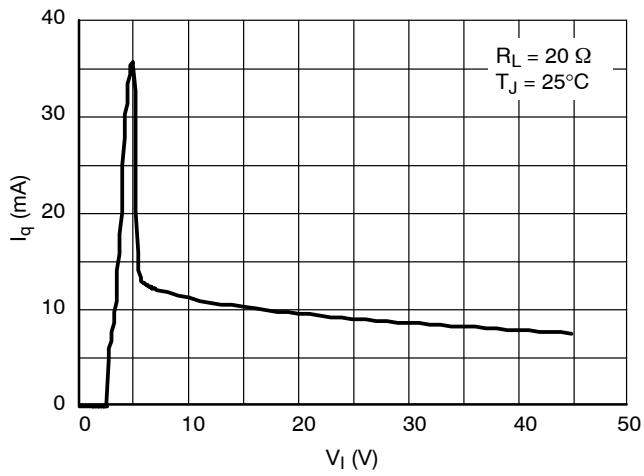

Figure 20. Current Consumption vs. Input Voltage

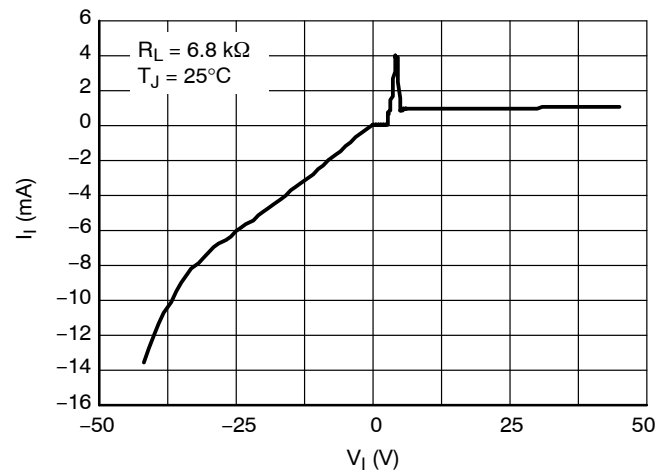

Figure 21. Input Current vs. Input Voltage

TYPICAL CHARACTERISTIC CURVES – 3.3 V Version



Figure 22. Output Voltage vs. Junction Temperature



Figure 23. Output Voltage vs. Input Voltage



Figure 24. Output Current vs. Input Voltage

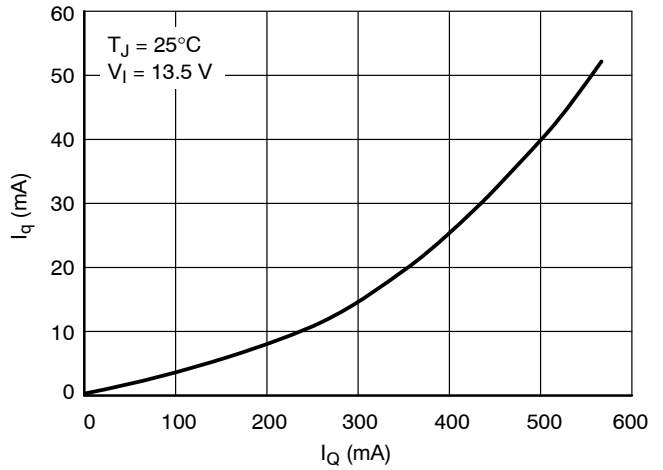

Figure 25. Current Consumption vs. Output Current (High Load)



Figure 26. Current Consumption vs. Output Current (Low Load)

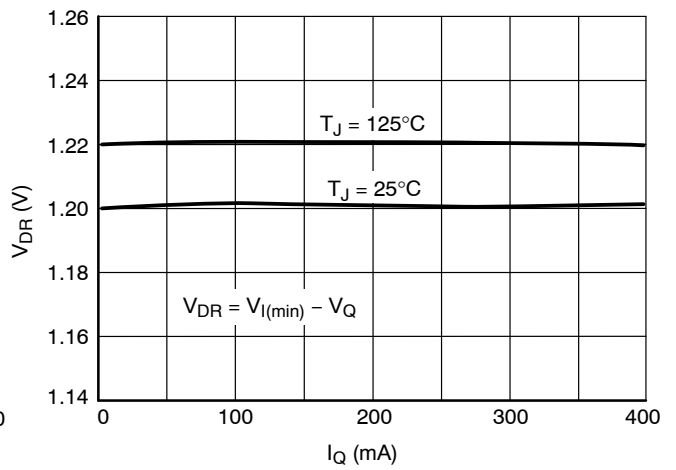

Figure 27. Voltage Drop vs. Output Current

NCV4274, NCV4274A

TYPICAL CHARACTERISTIC CURVES – 3.3 V Version

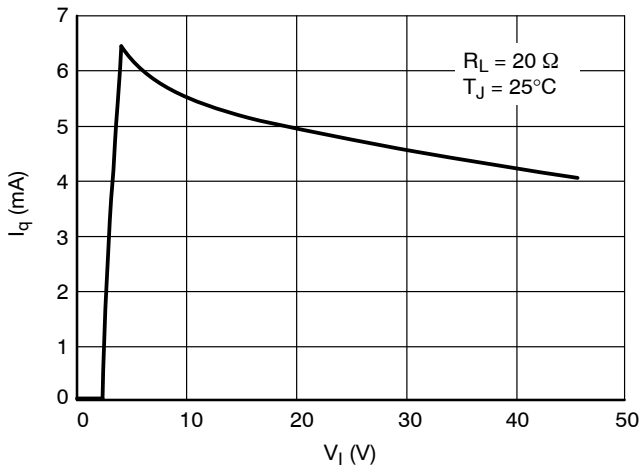

Figure 28. Current Consumption vs. Input Voltage



Figure 29. Input Current vs. Input Voltage

NCV4274, NCV4274A

TYPICAL CHARACTERISTIC CURVES – 2.5 V Version

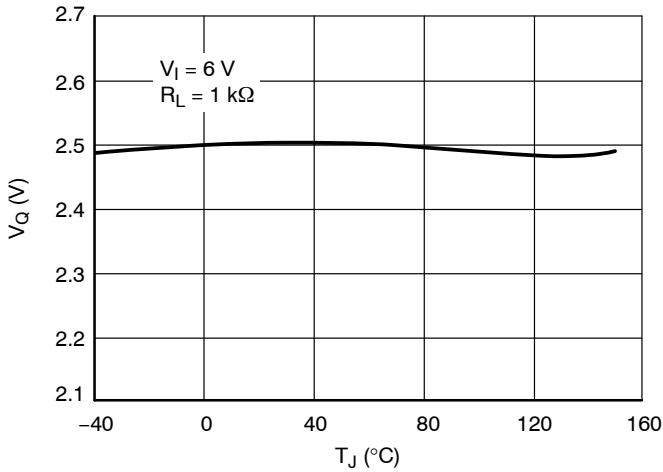

Figure 30. Output Voltage vs. Junction Temperature

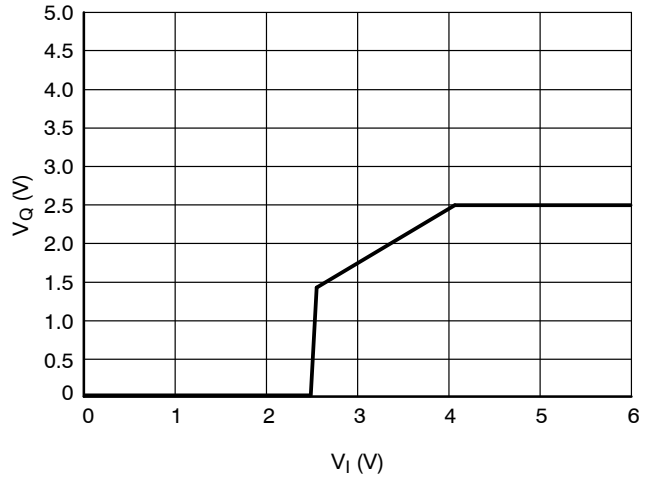

Figure 31. Output Voltage vs. Input Voltage

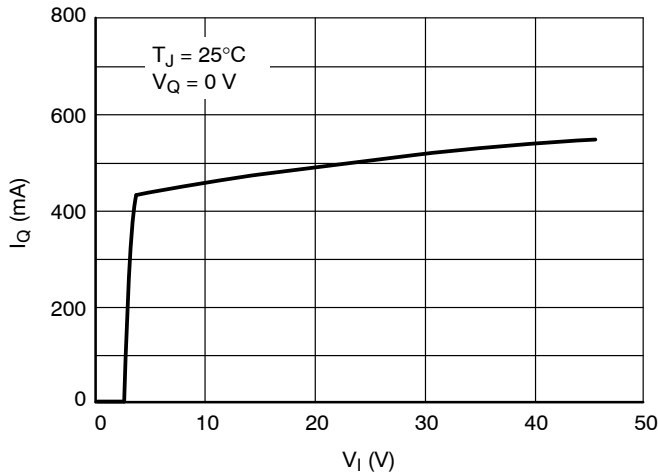

Figure 32. Output Current vs. Input Voltage



Figure 33. Current Consumption vs. Output Current (High Load)

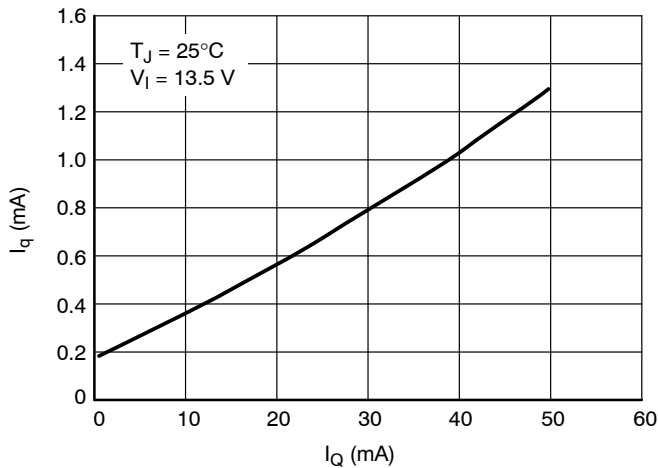

Figure 34. Current Consumption vs. Output Current (Low Load)

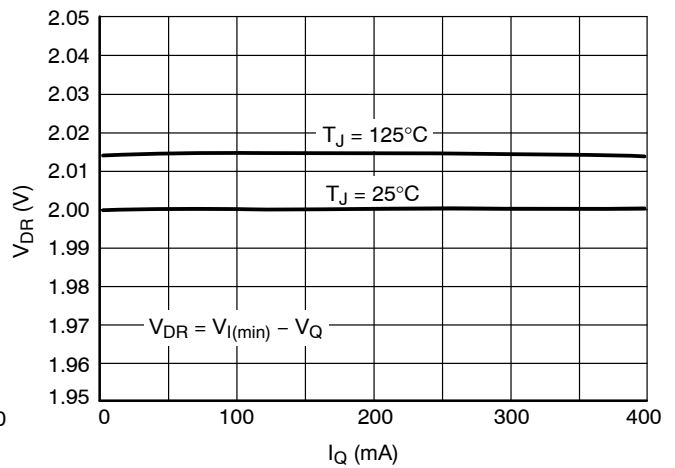

Figure 35. Voltage Drop vs. Output Current

NCV4274, NCV4274A

TYPICAL CHARACTERISTIC CURVES – 2.5 V Version



Figure 36. Current Consumption vs. Input Voltage



Figure 37. Input Current vs. Input Voltage

APPLICATION DESCRIPTION

Output Regulator

The output is controlled by a precision trimmed reference and error amplifier. The PNP output has saturation control for regulation while the input voltage is low, preventing over saturation. Current limit and voltage monitors complement the regulator design to give safe operating signals to the processor and control circuits.

Stability Considerations

The input capacitor C_{I1} in Figure 2 is necessary for compensating input line reactance. Possible oscillations caused by input inductance and input capacitance can be damped by using a resistor of approximately 1 Ω in series with C_{I2}.

The output or compensation capacitor helps determine three main characteristics of a linear regulator: startup delay, load transient response and loop stability.

The capacitor value and type should be based on cost, availability, size and temperature constraints. The aluminum electrolytic capacitor is the least expensive solution, but, if the circuit operates at low temperatures (–25°C to –40°C), both the value and ESR of the capacitor will vary considerably. The capacitor manufacturer’s data sheet usually provides this information.

The value for the output capacitor C_O shown in Figure 2 should work for most applications; however, it is not necessarily the optimized solution. Stability is guaranteed at values C_O ≥ 2.2 μF and an ESR ≤ 2.5 Ω within the operating temperature range. Actual limits are shown in a graph in the Typical Performance Characteristics section.

Calculating Power Dissipation in a Single Output Linear Regulator

The maximum power dissipation for a single output regulator (Figure 3) is:

$$P_{D(max)} = [V_{I(max)} - V_{Q(min)}]I_{Q(max)} + V_{I(max)}I_q \quad (\text{eq. 1})$$

Where:

- V_{I(max)} is the maximum input voltage,
- V_{Q(min)} is the minimum output voltage,
- I_{Q(max)} is the maximum output current for the application, and
- I_q is the quiescent current the regulator consumes at I_{Q(max)}.

Once the value of P_{D(max)} is known, the maximum permissible value of R_{θJA} can be calculated:

$$P_{\theta JA} = \frac{(150\text{ C} - T_A)}{P_D} \quad (\text{eq. 2})$$

The value of R_{θJA} can then be compared with those in the package section of the data sheet. Those packages with R_{θJA}’s less than the calculated value in Equation 2 will keep the die temperature below 150°C. In some cases, none of the packages will be sufficient to dissipate the heat generated by the IC, and an external heat sink will be required. The current flow and voltages are shown in the Measurement Circuit Diagram.

Heat Sinks

A heat sink effectively increases the surface area of the package to improve the flow of heat away from the IC and into the surrounding air.

Each material in the heat flow path between the IC and the outside environment will have a thermal resistance. Like series electrical resistances, these resistances are summed to determine the value of R_{θJA}:

$$R_{\theta JA} = R_{\theta JC} + R_{\theta CS} + R_{\theta SA} \quad (\text{eq. 3})$$

Where:

- R_{θJC} = the junction–to–case thermal resistance,
 - R_{θCS} = the case–to–heat sink thermal resistance, and
 - R_{θSA} = the heat sink–to–ambient thermal resistance.
- R_{θJC} appears in the package section of the data sheet.

Like R_{θJA}, it too is a function of package type. R_{θCS} and R_{θSA} are functions of the package type, heat sink and the interface between them. These values appear in data sheets of heat sink manufacturers. Thermal, mounting, and heat sinking are discussed in the ON Semiconductor application note AN1040/D, available on the ON Semiconductor Website.

NCV4274, NCV4274A

ORDERING INFORMATION4

Device*	Output Voltage Accuracy	Output Voltage	Package	Shipping†
NCV4274ADS85R4G	2%	8.5 V	D2PAK (Pb-Free)	800 / Tape & Reel
NCV4274DS50G	4%	5.0 V	D2PAK (Pb-Free)	50 Units / Rail
NCV4274DS50R4G	4%	5.0 V	D2PAK (Pb-Free)	800 / Tape & Reel
NCV4274DT50RKG	4%	5.0 V	DPAK (Pb-Free)	2500 / Tape & Reel
NCV4274ADS50G	2%	5.0 V	D2PAK (Pb-Free)	50 Units / Rail
NCV4274ADS50R4G	2%	5.0 V	D2PAK (Pb-Free)	800 / Tape & Reel
NCV4274ADT50RKG	2%	5.0 V	DPAK (Pb-Free)	2500 / Tape & Reel
NCV4274ST33T3G	4%	3.3 V	SOT-223 (Pb-Free)	4000 / Tape & Reel
NCV4274DT33RKG	4%	3.3 V	DPAK (Pb-Free)	2500 / Tape & Reel
NCV4274AST33T3G	2%	3.3 V	SOT-223 (Pb-Free)	4000 / Tape & Reel
NCV4274ADT33RKG	2%	3.3 V	DPAK (Pb-Free)	2500 / Tape & Reel
NCV4274ADS33R4G	2%	3.3 V	D2PAK (Pb-Free)	800 / Tape & Reel
NCV4274ST25T3G	4%	2.5 V	SOT-223 (Pb-Free)	4000 / Tape & Reel
NCV4274AST25T3G	2%	2.5 V	SOT-223 (Pb-Free)	4000 / Tape & Reel

†For information on tape and reel specifications, including part orientation and tape sizes, please refer to our Tape and Reel Packaging Specifications Brochure, BRD8011/D.

*NCV Prefix for Automotive and Other Applications Requiring Unique Site and Control Change Requirements; AEC-Q100 Qualified and PPAP Capable.

MECHANICAL CASE OUTLINE

PACKAGE DIMENSIONS

ON Semiconductor®



SCALE 1:1

DPAK (SINGLE GAUGE)

CASE 369C

ISSUE F

DATE 21 JUL 2015



NOTES:

1. DIMENSIONING AND TOLERANCING PER ASME Y14.5M, 1994.
2. CONTROLLING DIMENSION: INCHES.
3. THERMAL PAD CONTOUR OPTIONAL WITHIN DIMENSIONS b3, L3 and Z.
4. DIMENSIONS D AND E DO NOT INCLUDE MOLD FLASH, PROTRUSIONS, OR BURRS. MOLD FLASH, PROTRUSIONS, OR GATE BURRS SHALL NOT EXCEED 0.006 INCHES PER SIDE.
5. DIMENSIONS D AND E ARE DETERMINED AT THE OUTERMOST EXTREMES OF THE PLASTIC BODY.
6. DATUMS A AND B ARE DETERMINED AT DATUM PLANE H.
7. OPTIONAL MOLD FEATURE.

DIM	INCHES		MILLIMETERS	
	MIN	MAX	MIN	MAX
A	0.086	0.094	2.18	2.38
A1	0.000	0.005	0.00	0.13
b	0.025	0.035	0.63	0.89
b2	0.028	0.045	0.72	1.14
b3	0.180	0.215	4.57	5.46
c	0.018	0.024	0.46	0.61
c2	0.018	0.024	0.46	0.61
D	0.235	0.245	5.97	6.22
E	0.250	0.265	6.35	6.73
e	0.090 BSC		2.29 BSC	
H	0.370	0.410	9.40	10.41
L	0.055	0.070	1.40	1.78
L1	0.114 REF		2.90 REF	
L2	0.020 BSC		0.51 BSC	
L3	0.035	0.050	0.89	1.27
L4	---	0.040	---	1.01
Z	0.155	---	3.93	---

GENERIC MARKING DIAGRAM*

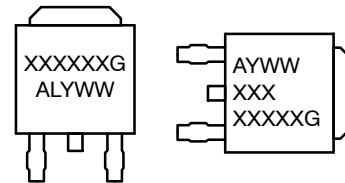

IC

Discrete

- XXXXXX = Device Code
- A = Assembly Location
- L = Wafer Lot
- Y = Year
- WW = Work Week
- G = Pb-Free Package

*This information is generic. Please refer to device data sheet for actual part marking.

- | | | | | |
|--|--|---|---|--|
| <p>STYLE 1:
PIN 1. BASE
2. COLLECTOR
3. EMITTER
4. COLLECTOR</p> | <p>STYLE 2:
PIN 1. GATE
2. DRAIN
3. SOURCE
4. DRAIN</p> | <p>STYLE 3:
PIN 1. ANODE
2. CATHODE
3. ANODE
4. CATHODE</p> | <p>STYLE 4:
PIN 1. CATHODE
2. ANODE
3. GATE
4. ANODE</p> | <p>STYLE 5:
PIN 1. GATE
2. ANODE
3. CATHODE
4. ANODE</p> |
| <p>STYLE 6:
PIN 1. MT1
2. MT2
3. GATE
4. MT2</p> | <p>STYLE 7:
PIN 1. GATE
2. COLLECTOR
3. EMITTER
4. COLLECTOR</p> | <p>STYLE 8:
PIN 1. N/C
2. CATHODE
3. ANODE
4. CATHODE</p> | <p>STYLE 9:
PIN 1. ANODE
2. CATHODE
3. RESISTOR ADJUST
4. CATHODE</p> | <p>STYLE 10:
PIN 1. CATHODE
2. ANODE
3. CATHODE
4. ANODE</p> |

SOLDERING FOOTPRINT*

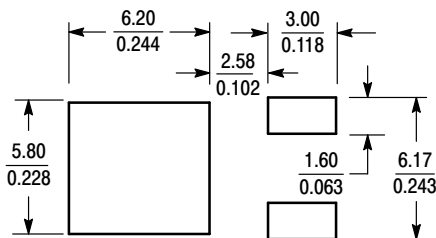

SCALE 3:1 (mm / inches)

*For additional information on our Pb-Free strategy and soldering details, please download the ON Semiconductor Soldering and Mounting Techniques Reference Manual, SOLDERRM/D.

DOCUMENT NUMBER:	98AON10527D	Electronic versions are uncontrolled except when accessed directly from the Document Repository. Printed versions are uncontrolled except when stamped "CONTROLLED COPY" in red.
DESCRIPTION:	DPAK (SINGLE GAUGE)	PAGE 1 OF 1

ON Semiconductor and ON are trademarks of Semiconductor Components Industries, LLC dba ON Semiconductor or its subsidiaries in the United States and/or other countries. ON Semiconductor reserves the right to make changes without further notice to any products herein. ON Semiconductor makes no warranty, representation or guarantee regarding the suitability of its products for any particular purpose, nor does ON Semiconductor assume any liability arising out of the application or use of any product or circuit, and specifically disclaims any and all liability, including without limitation special, consequential or incidental damages. ON Semiconductor does not convey any license under its patent rights nor the rights of others.

MECHANICAL CASE OUTLINE

PACKAGE DIMENSIONS

ON Semiconductor®

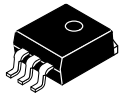

SCALE 1:1

D2PAK
CASE 418AF
ISSUE E

DATE 15 SEP 2015

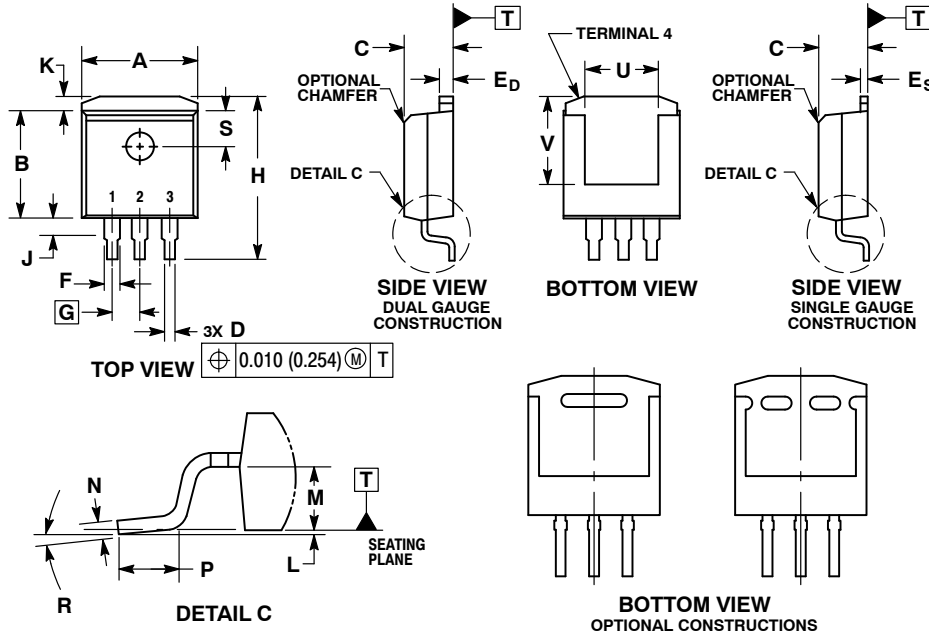

NOTES:

1. DIMENSIONING AND TOLERANCING PER ANSI Y14.5M, 1982.
2. CONTROLLING DIMENSION: INCHES.
3. TAB CONTOUR OPTIONAL WITHIN DIMENSIONS A AND K.
4. DIMENSIONS U AND V ESTABLISH A MINIMUM MOUNTING SURFACE FOR TERMINAL 4.
5. DIMENSIONS A AND B DO NOT INCLUDE MOLD FLASH OR GATE PROTRUSIONS. MOLD FLASH AND GATE PROTRUSIONS NOT TO EXCEED 0.025 (0.635) MAXIMUM.
6. SINGLE GAUGE DESIGN WILL BE SHIPPED AFTER FPCN EXPIRATION IN OCTOBER 2011.

DIM	INCHES		MILLIMETERS	
	MIN	MAX	MIN	MAX
A	0.386	0.403	9.804	10.236
B	0.356	0.368	9.042	9.347
C	0.170	0.180	4.318	4.572
D	0.026	0.036	0.660	0.914
E _D	0.045	0.055	1.143	1.397
E _S	0.018	0.026	0.457	0.660
F	0.051 REF		1.295 REF	
G	0.100 BSC		2.540 BSC	
H	0.539	0.579	13.691	14.707
J	0.125 MAX		3.175 MAX	
K	0.050 REF		1.270 REF	
L	0.000	0.010	0.000	0.254
M	0.088	0.102	2.235	2.591
N	0.018	0.026	0.457	0.660
P	0.058	0.078	1.473	1.981
R	0°	8°	0°	8°
S	0.116 REF		2.946 REF	
U	0.200 MIN		5.080 MIN	
V	0.250 MIN		6.350 MIN	

SOLDERING FOOTPRINT*

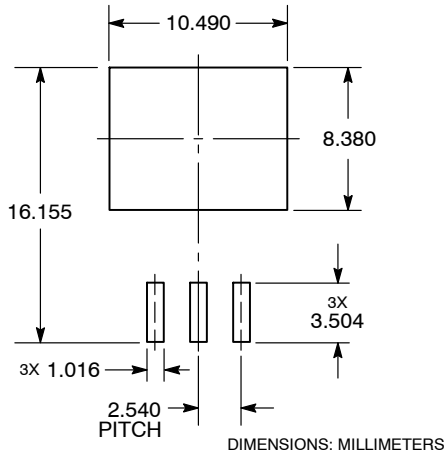

*For additional information on our Pb-Free strategy and soldering details, please download the ON Semiconductor Soldering and Mounting Techniques Reference Manual, SOLDERRM/D.

GENERIC MARKING DIAGRAM*

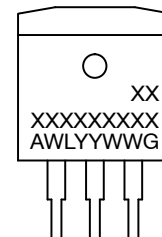

- XXXXX = Specific Device Code
- A = Assembly Location
- WL = Wafer Lot
- YY = Year
- WW = Work Week
- G = Pb-Free Package

*This information is generic. Please refer to device data sheet for actual part marking. Pb-Free indicator, "G", may or not be present.

DOCUMENT NUMBER:	98AON21981D	Electronic versions are uncontrolled except when accessed directly from the Document Repository. Printed versions are uncontrolled except when stamped "CONTROLLED COPY" in red.
DESCRIPTION:	D2PAK	PAGE 1 OF 1

ON Semiconductor and ON are trademarks of Semiconductor Components Industries, LLC dba ON Semiconductor or its subsidiaries in the United States and/or other countries. ON Semiconductor reserves the right to make changes without further notice to any products herein. ON Semiconductor makes no warranty, representation or guarantee regarding the suitability of its products for any particular purpose, nor does ON Semiconductor assume any liability arising out of the application or use of any product or circuit, and specifically disclaims any and all liability, including without limitation special, consequential or incidental damages. ON Semiconductor does not convey any license under its patent rights nor the rights of others.

ON Semiconductor and  are trademarks of Semiconductor Components Industries, LLC dba ON Semiconductor or its subsidiaries in the United States and/or other countries. ON Semiconductor owns the rights to a number of patents, trademarks, copyrights, trade secrets, and other intellectual property. A listing of ON Semiconductor's product/patent coverage may be accessed at www.onsemi.com/site/pdf/Patent-Marking.pdf. ON Semiconductor reserves the right to make changes without further notice to any products herein. ON Semiconductor makes no warranty, representation or guarantee regarding the suitability of its products for any particular purpose, nor does ON Semiconductor assume any liability arising out of the application or use of any product or circuit, and specifically disclaims any and all liability, including without limitation special, consequential or incidental damages. Buyer is responsible for its products and applications using ON Semiconductor products, including compliance with all laws, regulations and safety requirements or standards, regardless of any support or applications information provided by ON Semiconductor. "Typical" parameters which may be provided in ON Semiconductor data sheets and/or specifications can and do vary in different applications and actual performance may vary over time. All operating parameters, including "Typicals" must be validated for each customer application by customer's technical experts. ON Semiconductor does not convey any license under its patent rights nor the rights of others. ON Semiconductor products are not designed, intended, or authorized for use as a critical component in life support systems or any FDA Class 3 medical devices or medical devices with a same or similar classification in a foreign jurisdiction or any devices intended for implantation in the human body. Should Buyer purchase or use ON Semiconductor products for any such unintended or unauthorized application, Buyer shall indemnify and hold ON Semiconductor and its officers, employees, subsidiaries, affiliates, and distributors harmless against all claims, costs, damages, and expenses, and reasonable attorney fees arising out of, directly or indirectly, any claim of personal injury or death associated with such unintended or unauthorized use, even if such claim alleges that ON Semiconductor was negligent regarding the design or manufacture of the part. ON Semiconductor is an Equal Opportunity/Affirmative Action Employer. This literature is subject to all applicable copyright laws and is not for resale in any manner.

PUBLICATION ORDERING INFORMATION

LITERATURE FULFILLMENT:

Email Requests to: orderlit@onsemi.com

ON Semiconductor Website: www.onsemi.com

TECHNICAL SUPPORT

North American Technical Support:
Voice Mail: 1 800-282-9855 Toll Free USA/Canada
Phone: 011 421 33 790 2910

Europe, Middle East and Africa Technical Support:

Phone: 00421 33 790 2910

For additional information, please contact your local Sales Representative