

Trench Gate Power MOSFET

N-Channel Enhancement Mode
Avalanche Rated

IXTA102N15T
IXTH102N15T
IXTP102N15T
IXTQ102N15T

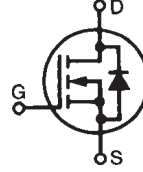

$V_{DSS} = 150V$
 $I_{D25} = 102A$
 $R_{DS(on)} \leq 18m\Omega$

TO-263 (IXTA)

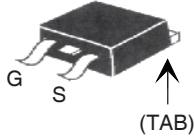

TO-247 (IXTH)

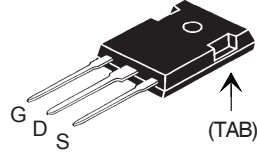

TO-220 (IXTP)

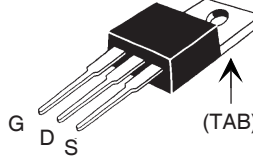

TO-3P (IXTQ)

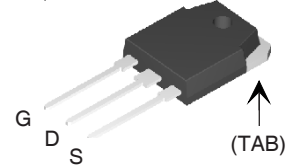

| Symbol | Test Conditions | Maximum Ratings | |
|---------------|--|------------------|------------|
| V_{DSS} | $T_J = 25^\circ C$ to $175^\circ C$ | 150 | V |
| V_{DGR} | $T_J = 25^\circ C$ to $175^\circ C$ $R_{GS} = 1M\Omega$ | 150 | V |
| V_{GSS} | Continuous | ± 20 | V |
| V_{GSM} | Transient | ± 30 | V |
| I_{D25} | $T_C = 25^\circ C$ | 102 | A |
| I_{LRMS} | Lead Current Limit, RMS | 75 | A |
| I_{DM} | $T_C = 25^\circ C$, pulse width limited by T_{JM} | 300 | A |
| I_A | $T_C = 25^\circ C$ | 51 | A |
| E_{AS} | $T_C = 25^\circ C$ | 750 | mJ |
| dV/dt | $I_S \leq I_{DM}$, $V_{DD} \leq V_{DSS}$, $T_J \leq 175^\circ C$ | 10 | V/ns |
| P_D | $T_C = 25^\circ C$ | 455 | W |
| T_J | | -55 ... +175 | $^\circ C$ |
| T_{JM} | | 175 | $^\circ C$ |
| T_{stg} | | -55 ... +175 | $^\circ C$ |
| T_L | 1.6mm (0.062 in.) from case for 10s | 300 | $^\circ C$ |
| T_{SOLD} | Plastic body for 10 seconds | 260 | $^\circ C$ |
| M_d | Mounting Torque (TO-220, TO-3P, TO-247) | 1.13 / 10 | Nmlb.in. |
| F_C | Mounting Force (TO-263) | 10..65/2.2..14.6 | N/lb. |
| Weight | TO-263 | 2.5 | g |
| | TO-220 | 3.0 | g |
| | TO-3P | 5.5 | g |
| | TO-247 | 6.0 | g |

G = Gate D = Drain
S = Source TAB = Drain

Features

- International standard packages
- Avalanche rated

Advantages

- Easy to mount
- Space savings
- High power density

Applications

- DC-DC converters
- Battery chargers
- Switched-mode and resonant-mode power supplies
- DC choppers
- AC motor drives
- Uninterruptible power supplies
- High speed power switching applications

| Symbol | Test Conditions ($T_J = 25^\circ C$ unless otherwise specified) | Characteristic Values | | |
|--------------|---|-----------------------|------|---------------|
| | | Min. | Typ. | Max. |
| BV_{DSS} | $V_{GS} = 0V$, $I_D = 250\mu A$ | 150 | | V |
| $V_{GS(th)}$ | $V_{DS} = V_{GS}$, $I_D = 1mA$ | 3.0 | | 5.0 V |
| I_{GSS} | $V_{GS} = \pm 20V$, $V_{DS} = 0V$ | | | ± 200 nA |
| I_{DSS} | $V_{DS} = V_{DSS}$ | | | 5 μA |
| | $V_{GS} = 0V$ $T_J = 150^\circ C$ | | | 250 μA |
| $R_{DS(on)}$ | $V_{GS} = 10V$, $I_D = 0.5 \cdot I_{D25}$, Note 1 | | | 18 m Ω |

| Symbol | Test Conditions ($T_J = 25^\circ\text{C}$ unless otherwise specified) | Characteristic Values | | |
|--------------|--|-----------------------|------|-----------|
| | | Min. | Typ. | Max. |
| g_{fs} | $V_{DS} = 10\text{V}, I_D = 0.5 \cdot I_{D25}$, Note 1 | 50 | 80 | S |
| C_{iss} | } $V_{GS} = 0\text{V}, V_{DS} = 25\text{V}, f = 1\text{MHz}$ | | 5220 | pF |
| C_{oss} | | | 685 | pF |
| C_{rss} | | | 95 | pF |
| $t_{d(on)}$ | } Resistive Switching Times $V_{GS} = 10\text{V}, V_{DS} = 0.5 \cdot V_{DSS}, I_D = 0.5 \cdot I_{D25}$ $R_G = 3.3\Omega$ (External) | | 20 | ns |
| t_r | | | 14 | ns |
| $t_{d(off)}$ | | | 25 | ns |
| t_f | | | 22 | ns |
| $Q_{g(on)}$ | } $V_{GS} = 10\text{V}, V_{DS} = 0.5 \cdot V_{DSS}, I_D = 25\text{A}$ | | 87 | nC |
| Q_{gs} | | | 23 | nC |
| Q_{gd} | | | 31 | nC |
| R_{thJC} | | | | 0.33 °C/W |
| R_{thCH} | (TO-220) | 0.50 | | °C/W |
| | (TO-3P & TO-247) | 0.25 | | °C/W |

Source-Drain Diode

| Symbol | Test Conditions ($T_J = 25^\circ\text{C}$ unless otherwise specified) | Characteristic Values | | |
|----------|---|--|------|-------|
| | | Min. | Typ. | Max. |
| I_S | $V_{GS} = 0\text{V}$ | | | 102 A |
| I_{SM} | Repetitive, pulse width limited by T_{JM} | | | 400 A |
| V_{SD} | $I_F = 100\text{A}, V_{GS} = 0\text{V}$, Note 1 | | | 1.3 V |
| t_{rr} | } $I_F = 51\text{A}, -di/dt = 100\text{A}/\mu\text{s}$ | | 97 | ns |
| I_{RM} | | } $V_R = 75\text{V}, V_{GS} = 0\text{V}$ | | 8.4 |
| Q_{RM} | | | 409 | |

Note 1: Pulse test, $t \leq 300\mu\text{s}$; duty cycle, $d \leq 2\%$.

IXYS reserves the right to change limits, test conditions, and dimensions.

IXYS MOSFETs and IGBTs are covered by one or more of the following U.S. patents:

| | | | | | | | | | |
|-----------|-----------|-----------|-----------|--------------|--------------|--------------|--------------|--------------|-------------|
| 4,835,592 | 4,931,844 | 5,049,961 | 5,237,481 | 6,162,665 | 6,404,065 B1 | 6,683,344 | 6,727,585 | 7,005,734 B2 | 7,157,338B2 |
| 4,850,072 | 5,017,508 | 5,063,307 | 5,381,025 | 6,259,123 B1 | 6,534,343 | 6,710,405 B2 | 6,759,692 | 7,063,975 B2 | |
| 4,881,106 | 5,034,796 | 5,187,117 | 5,486,715 | 6,306,728 B1 | 6,583,505 | 6,710,463 | 6,771,478 B2 | 7,071,537 | |

TO-263 (IXTA) Outline

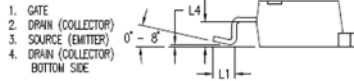
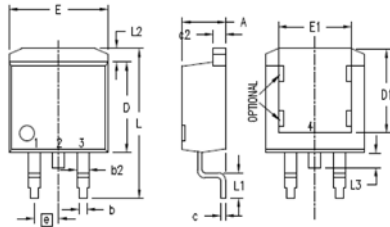

- 1. GATE
 - 2. DRAIN (COLLECTOR)
 - 3. SOURCE (EMITTER)
 - 4. DRAIN (COLLECTOR)
- BOTTOM SIDE

| SYM | INCHES | | MILLIMETERS | |
|-----|----------|------|-------------|-------|
| | MIN | MAX | MIN | MAX |
| A | .160 | .190 | 4.06 | 4.83 |
| A1 | .080 | .110 | 2.03 | 2.79 |
| b | .020 | .039 | 0.51 | 0.99 |
| b2 | .045 | .055 | 1.14 | 1.40 |
| c | .016 | .029 | 0.40 | 0.74 |
| c2 | .045 | .055 | 1.14 | 1.40 |
| D | .340 | .380 | 8.64 | 9.65 |
| D1 | .315 | .350 | 8.00 | 8.89 |
| E | .380 | .410 | 9.65 | 10.41 |
| E1 | .245 | .320 | 6.22 | 8.13 |
| e | .100 BSC | | 2.54 BSC | |
| L | .575 | .625 | 14.61 | 15.88 |
| L1 | .090 | .110 | 2.29 | 2.79 |
| L2 | .040 | .055 | 1.02 | 1.40 |
| L3 | .050 | .070 | 1.27 | 1.78 |
| L4 | 0 | .005 | 0 | 0.13 |

TO-247 (IXTH) Outline

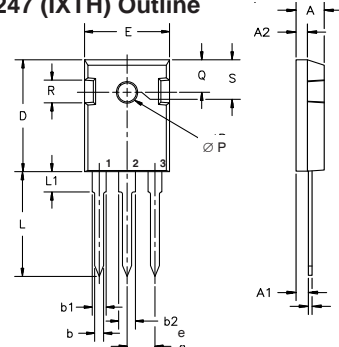

- Terminals: 1 - Gate
- 2 - Drain
- 3 - Source
- Tab - Drain

| Dim. | Millimeter | | Inches | |
|----------------|------------|-------|---------|-------|
| | Min. | Max. | Min. | Max. |
| A | 4.7 | 5.3 | .185 | .209 |
| A ₁ | 2.2 | 2.54 | .087 | .102 |
| A ₂ | 2.2 | 2.6 | .059 | .098 |
| b | 1.0 | 1.4 | .040 | .055 |
| b ₁ | 1.65 | 2.13 | .065 | .084 |
| b ₂ | 2.87 | 3.12 | .113 | .123 |
| C | .4 | .8 | .016 | .031 |
| D | 20.80 | 21.46 | .819 | .845 |
| E | 15.75 | 16.26 | .610 | .640 |
| e | 5.20 | 5.72 | 0.205 | 0.225 |
| L | 19.81 | 20.32 | .780 | .800 |
| L1 | | 4.50 | | .177 |
| ∅P | 3.55 | 3.65 | .140 | .144 |
| Q | 5.89 | 6.40 | 0.232 | 0.252 |
| R | 4.32 | 5.49 | .170 | .216 |
| S | 6.15 BSC | | 242 BSC | |

TO-220 (IXTP) Outline

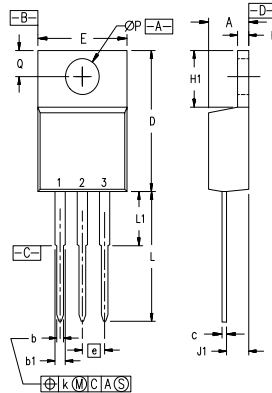

- Pins: 1 - Gate
- 2 - Drain
- 3 - Source
- 4 - Drain

| SYM | INCHES | | MILLIMETERS | |
|-----|----------|------|-------------|-------|
| | MIN | MAX | MIN | MAX |
| A | .170 | .190 | 4.32 | 4.83 |
| b | .025 | .040 | 0.64 | 1.02 |
| b1 | .045 | .065 | 1.15 | 1.65 |
| c | .014 | .022 | 0.35 | 0.56 |
| D | .580 | .630 | 14.73 | 16.00 |
| E | .390 | .420 | 9.91 | 10.66 |
| e | .100 BSC | | 2.54 BSC | |
| F | .045 | .055 | 1.14 | 1.40 |
| H1 | .230 | .270 | 5.85 | 6.85 |
| J1 | .090 | .110 | 2.29 | 2.79 |
| k | 0 | .015 | 0 | 0.38 |
| L | .500 | .550 | 12.70 | 13.97 |
| L1 | .110 | .230 | 2.79 | 5.84 |
| ∅P | .139 | .161 | 3.53 | 4.08 |
| Q | .100 | .125 | 2.54 | 3.18 |

TO-3P (IXTQ) Outline

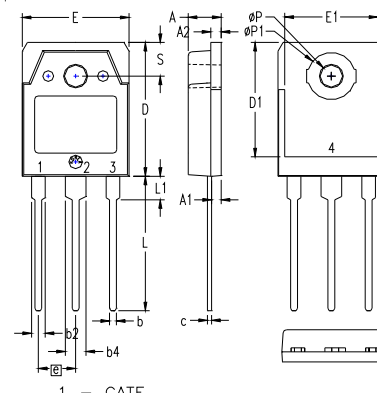

- 1 - GATE
- 2 - DRAIN (COLLECTOR)
- 3 - SOURCE (EMITTER)
- 4 - DRAIN (COLLECTOR)

| SYM | INCHES | | MILLIMETERS | |
|-----|----------|------|-------------|-------|
| | MIN | MAX | MIN | MAX |
| A | .185 | .193 | 4.70 | 4.90 |
| A1 | .051 | .059 | 1.30 | 1.50 |
| A2 | .057 | .065 | 1.45 | 1.65 |
| b | .035 | .045 | 0.90 | 1.15 |
| b2 | .075 | .087 | 1.90 | 2.20 |
| b4 | .114 | .126 | 2.90 | 3.20 |
| c | .022 | .031 | 0.55 | 0.80 |
| D | .780 | .799 | 19.80 | 20.30 |
| D1 | .665 | .677 | 16.90 | 17.20 |
| E | .610 | .622 | 15.50 | 15.80 |
| E1 | .531 | .539 | 13.50 | 13.70 |
| e | .215 BSC | | 5.45 BSC | |
| L | .779 | .795 | 19.80 | 20.20 |
| L1 | .134 | .142 | 3.40 | 3.60 |
| ∅P | .126 | .134 | 3.20 | 3.40 |
| ∅P1 | .272 | .280 | 6.90 | 7.10 |
| S | .193 | .201 | 4.90 | 5.10 |

Fig. 1. Output Characteristics @ 25°C

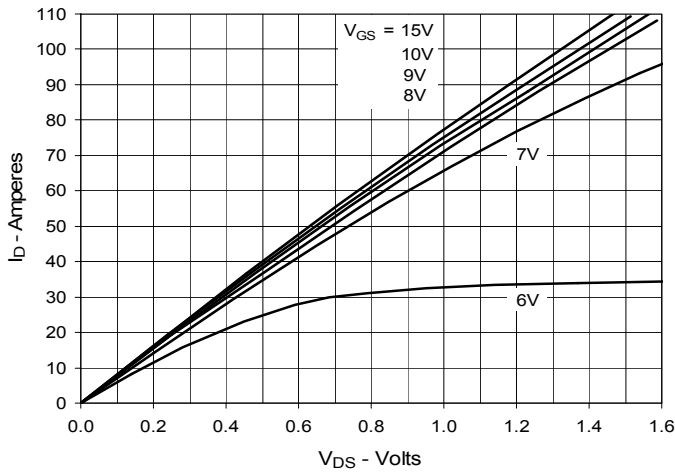

Fig. 2. Extended Output Characteristics @ 25°C

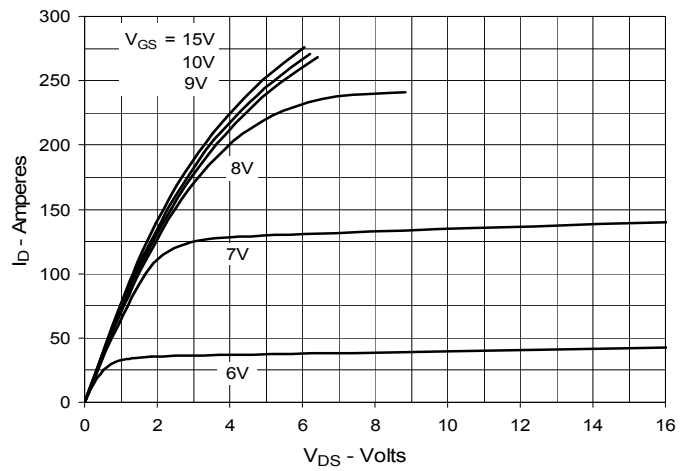

Fig. 3. Output Characteristics @ 150°C

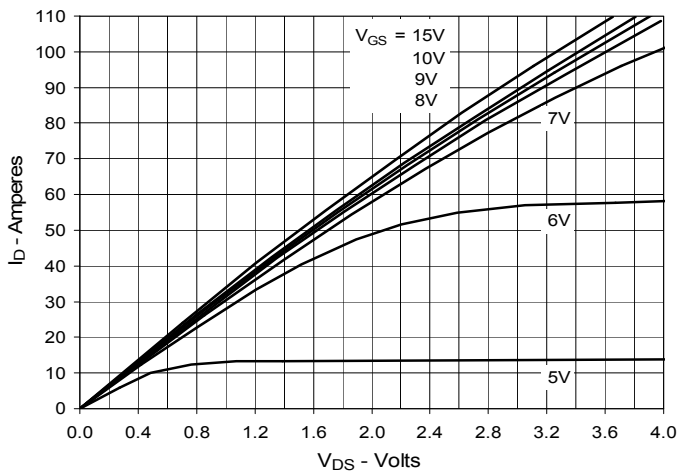

Fig. 4. $R_{DS(on)}$ Normalized to $I_D = 51A$ Value vs. Junction Temperature

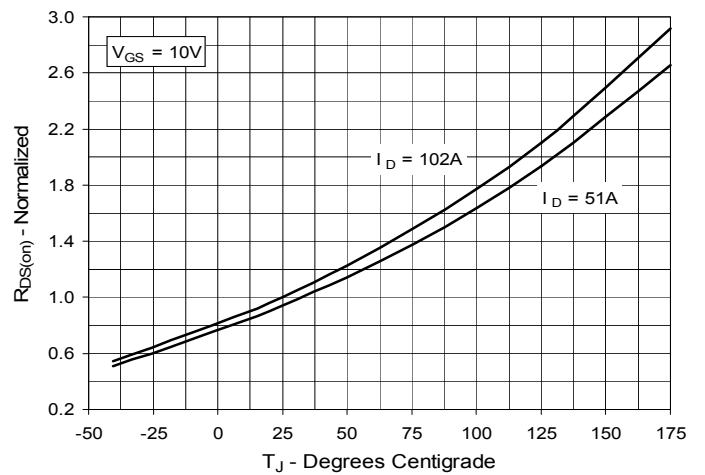

Fig. 5. $R_{DS(on)}$ Normalized to $I_D = 51A$ Value vs. Drain Current

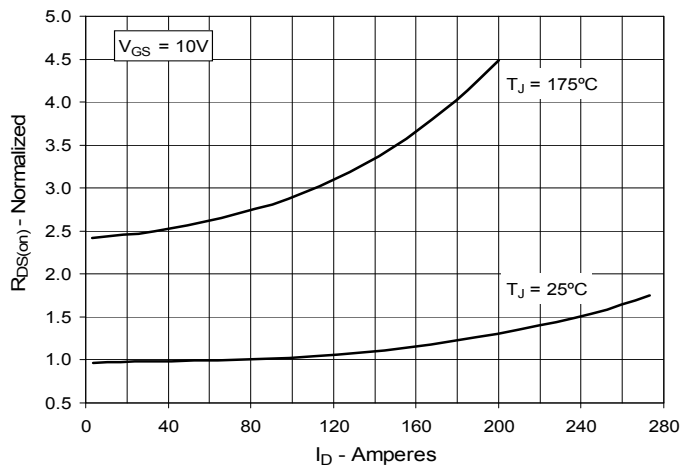

Fig. 6. Drain Current vs. Case Temperature

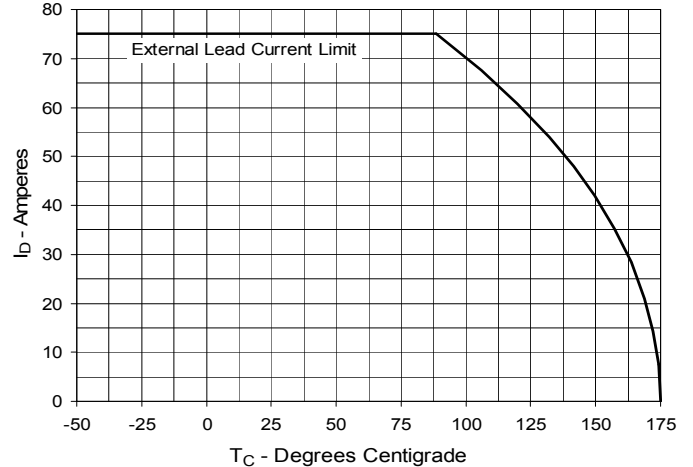

Fig. 7. Input Admittance

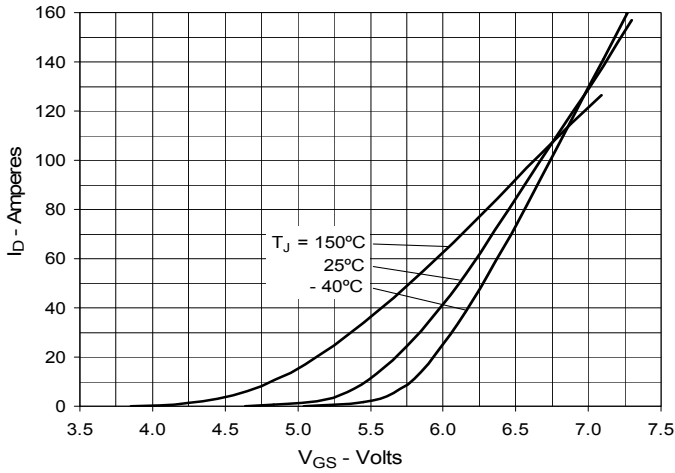

Fig. 8. Transconductance

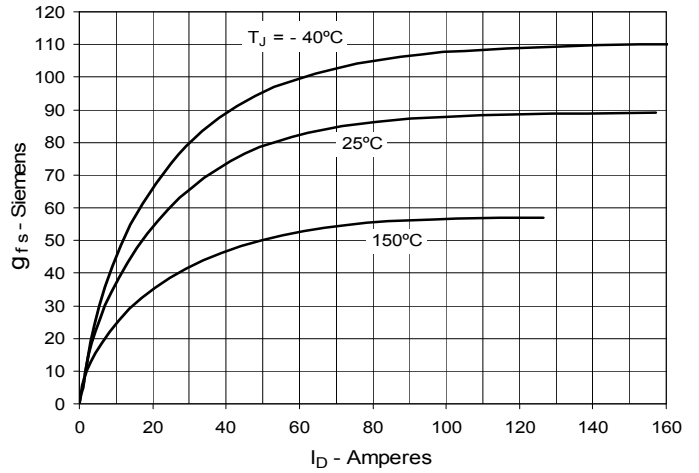

Fig. 9. Forward Voltage Drop of Intrinsic Diode

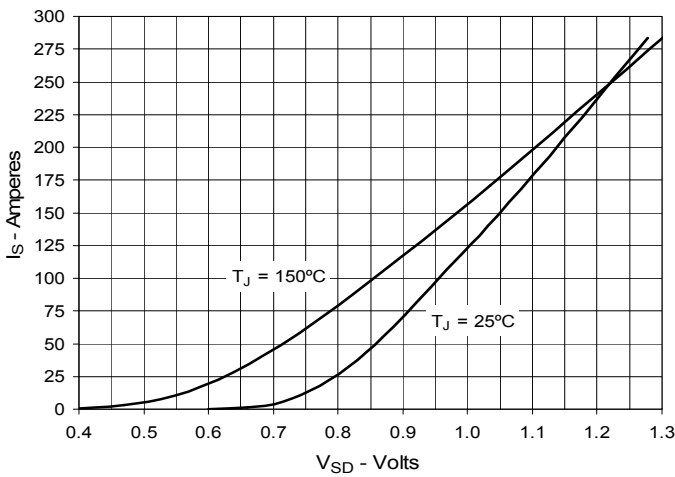

Fig. 10. Gate Charge

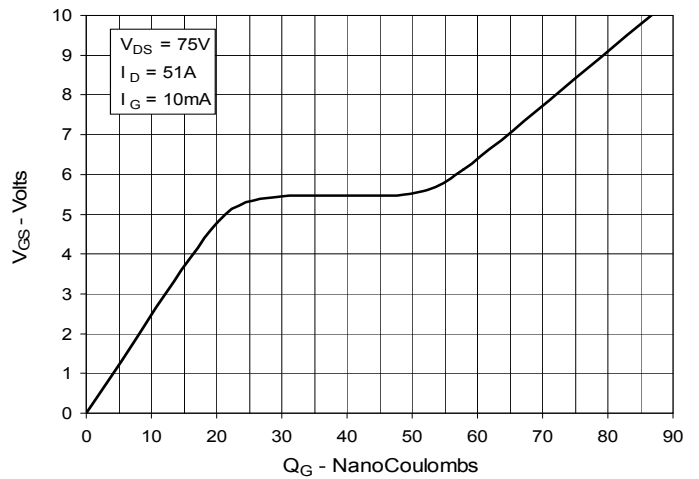

Fig. 11. Capacitance

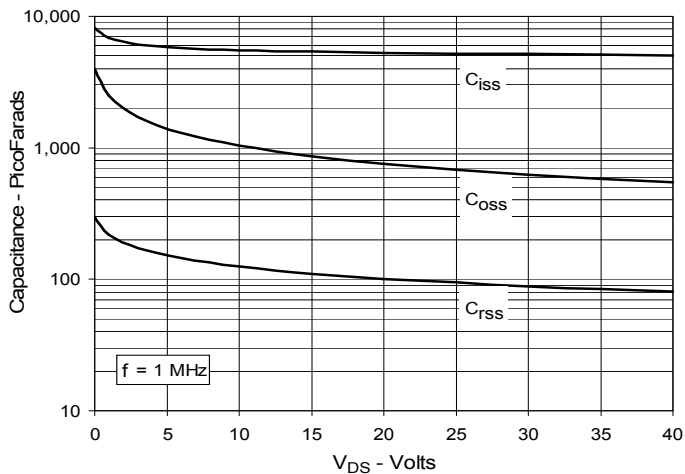
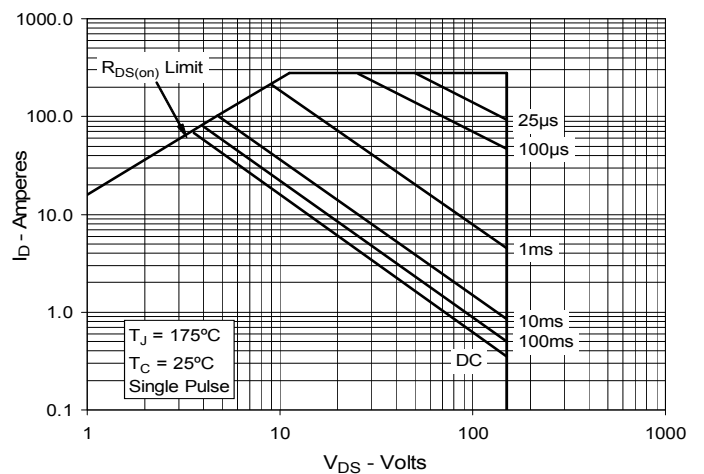
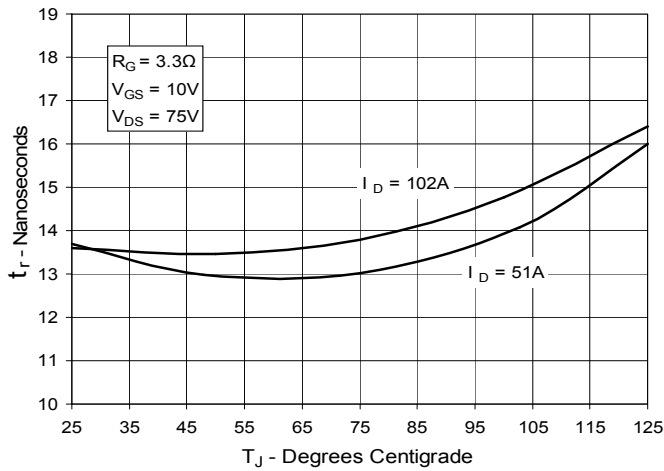

Fig. 12. Forward-Bias Safe Operating Area



**Fig. 13. Resistive Turn-on
Rise Time vs. Junction Temperature**



**Fig. 14. Resistive Turn-on
Rise Time vs. Drain Current**

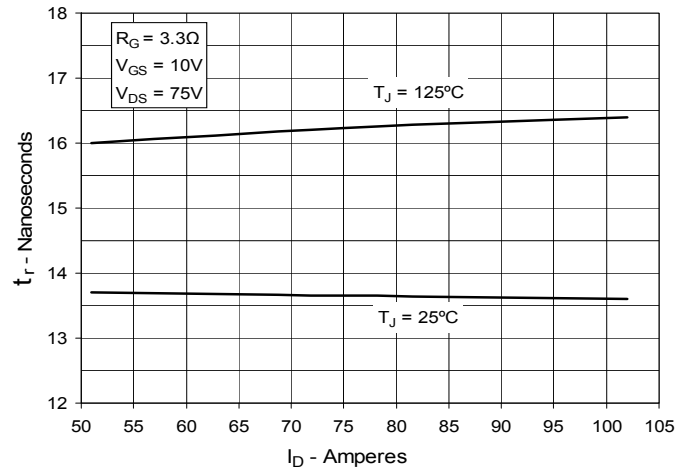

**Fig. 15. Resistive Turn-on
Switching Times vs. Gate Resistance**

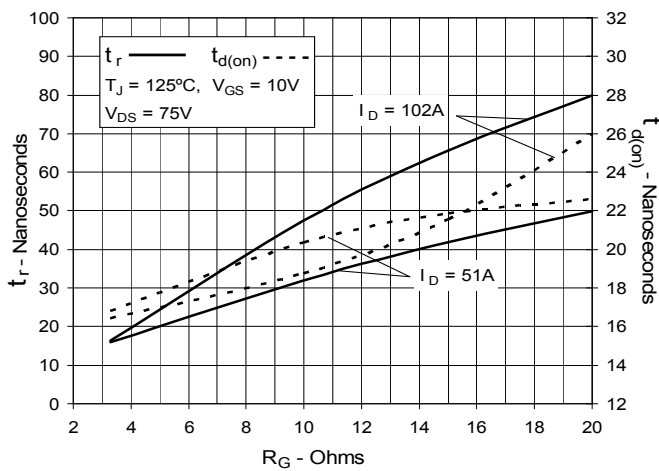

**Fig. 16. Resistive Turn-off
Switching Times vs. Junction Temperature**

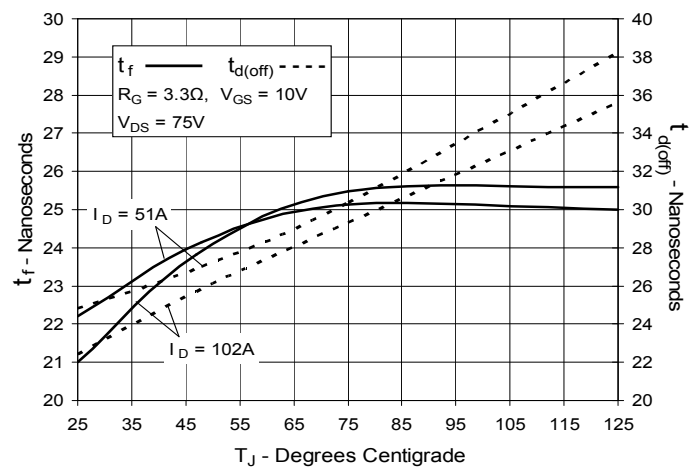

**Fig. 17. Resistive Turn-off
Switching Times vs. Drain Current**

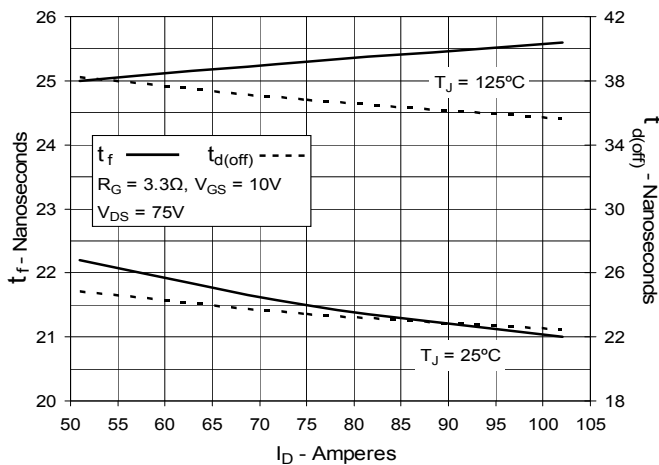

**Fig. 18. Resistive Turn-off
Switching Times vs. Gate Resistance**

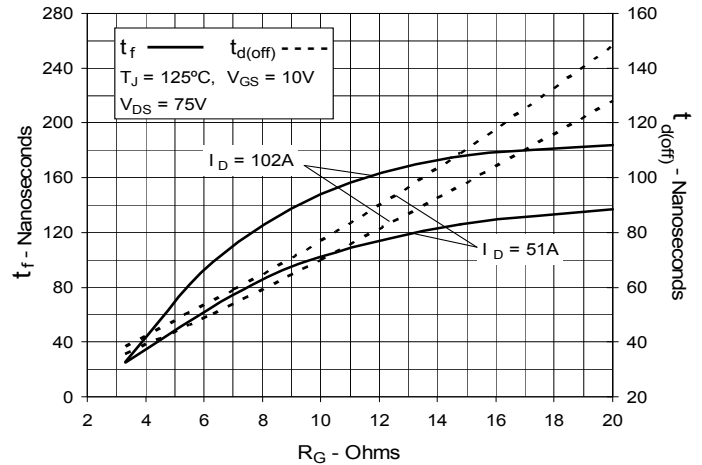

Fig. 19. Maximum Transient Thermal Impedance

