

"High Frequency Ceramic Solutions"

2.45 GHz High Gain SMD Chip Antenna

P/N 2450AT45A100

Detail Specification: 11/7/2016

Page 1 of 10

Would you like a quote? Click here: www.johansontechnology.com/request-a-quote (please provide annual usage)

General Specifications		Antenna Gain Based on Orientation	
Part Number	2450AT45A100	Mounting1 Vertical Orientation (Page 2)	2.2 dBi typ. (XZ-V)
Frequency Range	2400 - 2500 MHz	Mounting2 "Horizontal Orientation Type A" (Pages 4/5)	1.5 dBi typ. (XZ-V)
Operating Temp	-40°C to +125°C	Mounting3 "Horizontal Orientation Type B" (Pages 7/8)	1.3 dBi typ. (XZ-V)
Storage Temp	-40°C to +85°C		
Input Power	3W max. (CW)		
Reel Quantity	1,000		

Use our antenna design services! www.johansontechnology.com/ipc-antenna-services

2 Free layout reviews and if you need us to tune and characterize the antenna on your design (anechoic chamber) we can do that too (lab fee may apply for the latter).

Part Number Explanation			
P/N Suffix	Packaging Style*	T & R (1000pcs/reel)	Suffix = E Eg. 2450AT45A100E
		Bulk (loose pieces)	Suffix = S Eg. 2450AT45A100S
	Termination style	100% Matte Tin	
	Evaluation Boards (1-port SMA antenna test boards, pre-tuned)	2450AT45A100-EB1SMA (Page 2)	
2450AT45A100-EB2SMA (Page 5)			
2450AT45A100-EB3SMA (Page 8)			

Mechanical Specifications		
	In	mm
L	0.374 ± 0.008	9.50 ± 0.20
W	0.079 ± 0.008	2.00 ± 0.20
T	0.047 +0.004/-0.008	1.20 +0.1/-0.2
a	0.020 ± 0.012	0.50 ± 0.30

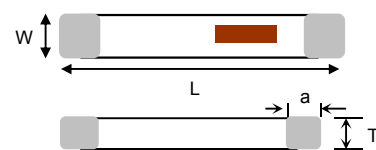

Terminal Configuration	
No	Function
1	Feeding Point
2	NC



Mounting Considerations 1: "Vertical Orientation"

Mount these devices with red mark facing up. *Line width should be designed to provide 50Ω impedance matching characteristics.

Want the layout file of this? Send us a message at:
www.johansontechnology.com/ask-a-question

Let us help you design this antenna to your PCB and/or optimize your layout for best radiated performance. Send us a message by clicking on the link above.

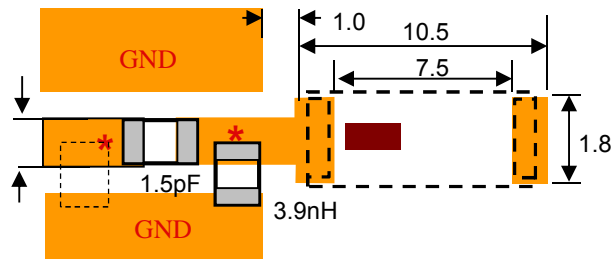

These matching circuit values only apply to Johanson's evaluation board, they will be different on the client's PCB, see pages 2, 5 and 10 for details.

Johanson Technology, Inc. reserves the right to make design changes without notice.

All sales are subject to Johanson Technology, Inc. terms and conditions.



www.johansontechnology.com

4001 Calle Tecate • Camarillo, CA 93012 • TEL 805.389.1166 FAX 805.389.1821

Ver 3.1

2016 Johanson Technology, Inc. All Rights Reserved

"High Frequency Ceramic Solutions"

2.45 GHz High Gain SMD Chip Antenna

P/N 2450AT45A100

Detail Specification: 11/7/2016

Page 2 of 10

Typical Electrical Specs for "Vertical Orientation" (T=25°C)

Frequency Range	2400 - 2500 Mhz	Peak Gain	2.2 dBi typ. (XZ-V)
Return Loss	9.5 dB min.	Average Gain	1.0 dBi typ. (XZ-V)

Typical Electrical Characteristics for Mounting Considerations 1 "Vertical Orientation" (T=25°C)

Test Board

Orderable Evaluation board:
p/n: 2450AT45A100-EB1SMA

Let us help you tune/optimize the antenna!
Click on the link below

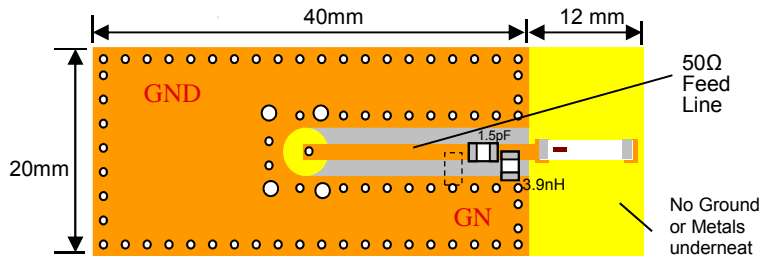

Note: It is recommended that the designer leave available slots for a "pi" (or shunt-series-shunt) network. The antenna matching network values above are used when antenna is mited on Johanson's evaluation board. The matching values on client's PCB will be different, go to: <http://johansontechnology.com/tuning> and see how to obtain the new values. If you need further help, contact our RF Applications Eng Team at: www.johansontechnology.com/ask-a-question

Return Loss

a) Without a Matching Circuit

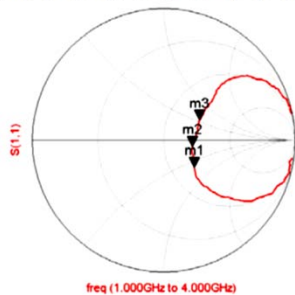
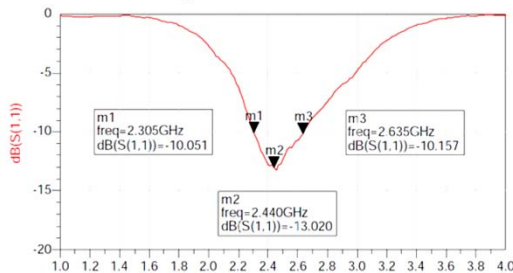

a) With a Matching Circuit

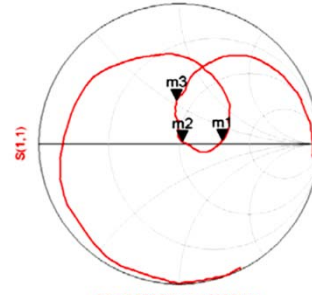
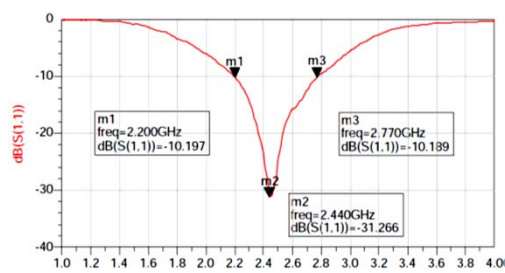

Johanson Technology, Inc. reserves the right to make design changes without notice.
All sales are subject to Johanson Technology, Inc. terms and conditions.



www.johansontechnology.com
4001 Calle Tecate • Camarillo, CA 93012 • TEL 805.389.1166 FAX 805.389.1821

Ver 3.1

2016 Johanson Technology, Inc. All Rights Reserved

"High Frequency Ceramic Solutions"

2.45 GHz High Gain SMD Chip Antenna

P/N 2450AT45A100

Detail Specification: 11/7/2016

Page 3 of 10

Typical Radiation Patterns for "Vertical Orientation" (@25C)

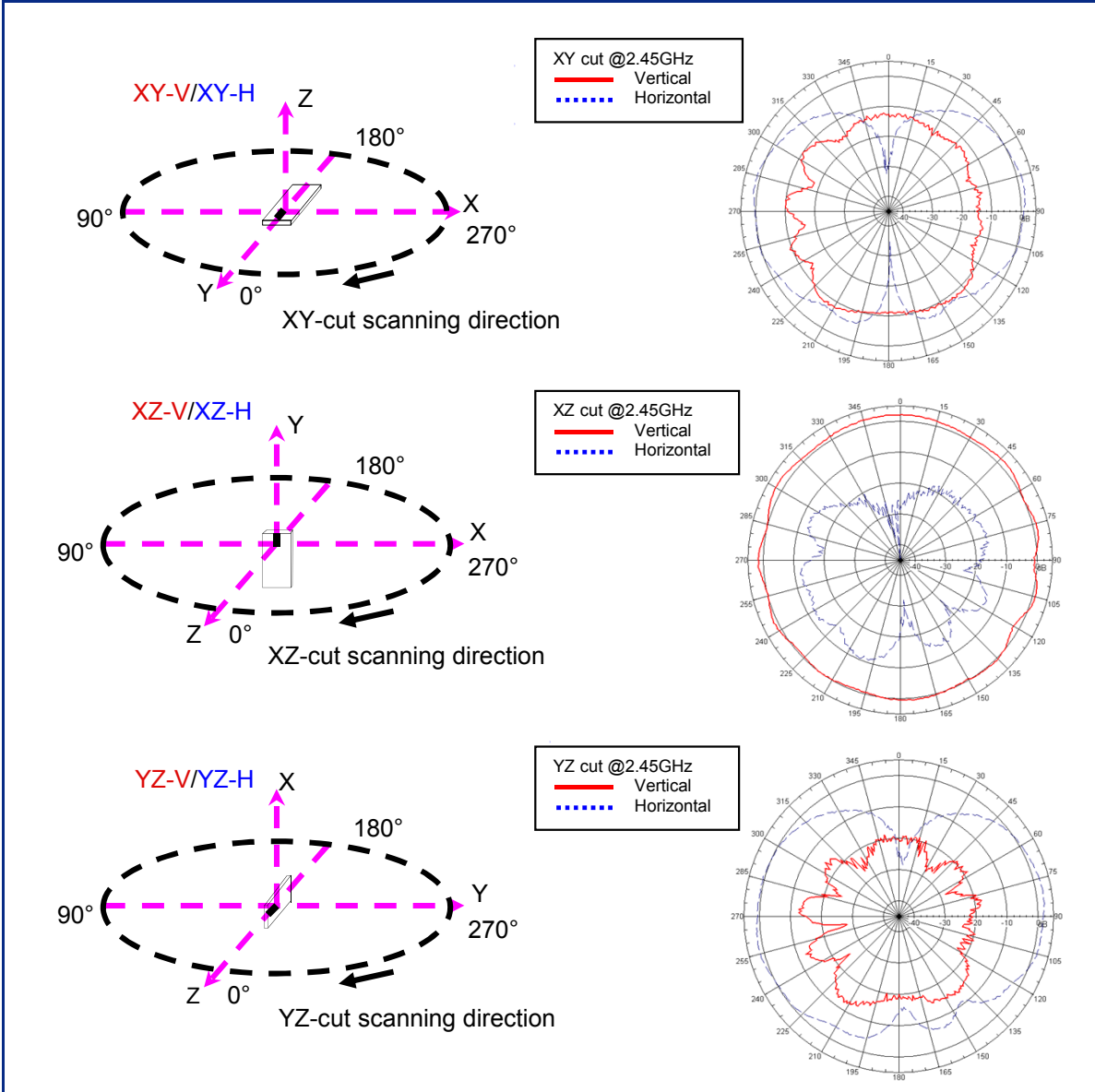

Johanson Technology, Inc. reserves the right to make design changes without notice.
All sales are subject to Johanson Technology, Inc. terms and conditions.



www.johansontechnology.com
4001 Calle Tecate • Camarillo, CA 93012 • TEL 805.389.1166 FAX 805.389.1821

Ver 3.1

2016 Johanson Technology, Inc. All Rights Reserved

"High Frequency Ceramic Solutions"

2.45 GHz High Gain SMD Chip Antenna

P/N 2450AT45A100

Detail Specification: 11/7/2016

Page 4 of 10

Typical Electrical Specs for Mounting Considerations 2 - "Horizontal Orientation Type A" (T=25°C)

Frequency Range	2400 - 2500 Mhz	Peak Gain	1.5 dBi typ. (XZ-V)
Return Loss	9.5 dB min.	Average Gain	0.0 dBi typ. (XZ-V)

Mounting Considerations 2 - "Horizontal Orientation Type A"

Mount these devices with brown mark facing up. Units: mm

*Line width should be designed to provide 50Ω impedance matching characteristics. Units in mm

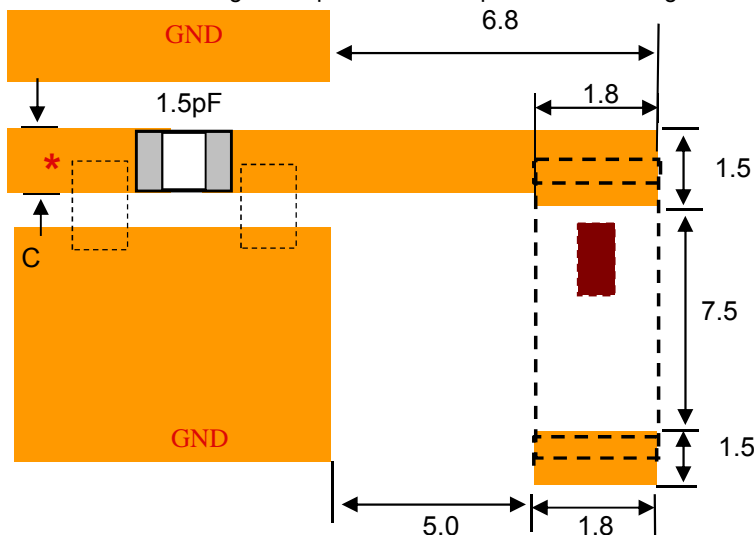

EVB p/n:
2450AT45A100-EB2SMA

"C" Dimension will depend on the width of the trace required for it to have a 50ohm characteristic impedance (i.e. coplanar waveguide theory)

Let us help you tune/optimize the antenna! Click on the link below

www.johansontechnology.com/ask-a-question

*These matching circuit values only apply to Johanson's evaluation board, they will be different on the client's PCB, see pages 5 and 10

Johanson Technology, Inc. reserves the right to make design changes without notice.
All sales are subject to Johanson Technology, Inc. terms and conditions.



www.johansontechnology.com
4001 Calle Tecate • Camarillo, CA 93012 • TEL 805.389.1166 FAX 805.389.1821

Ver 3.1

2016 Johanson Technology, Inc. All Rights Reserved

"High Frequency Ceramic Solutions"

2.45 GHz High Gain SMD Chip Antenna

P/N 2450AT45A100

Detail Specification: 11/7/2016

Page 5 of 10

Typical Electrical Characteristics: Mounting Considerations 2 "Horizontal Orientation Type A" (T=25°C)

Test Board

Orderable Evaluation Board
p/n: 2450AT45A100-EB2SMA

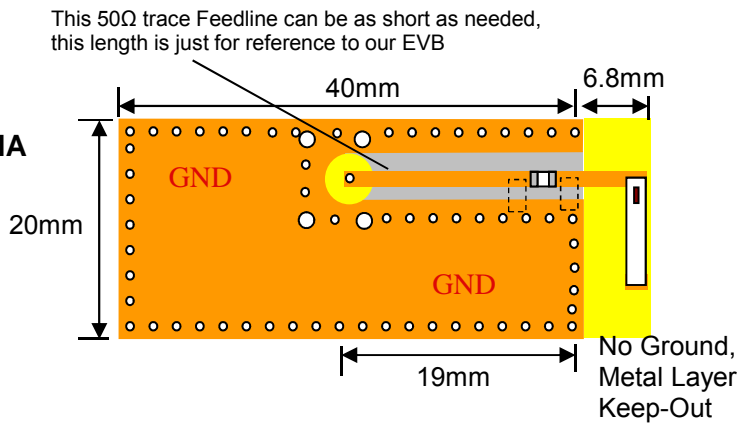

Note: It is recommended that the designer leave available slots for a "pi" (or shunt-series-shunt) network. The antenna matching network values above are used when antenna is mounted on Johanson's evaluation board. The matching values on client's PCB will be different, go to: <http://johansontechnology.com/tuning> and see how to obtain the new values. If you need further help, contact our RF Applications Eng Team at: <http://www.johansontechnology.com/ask-a-question>

Return Loss

a) With Matching Circuit

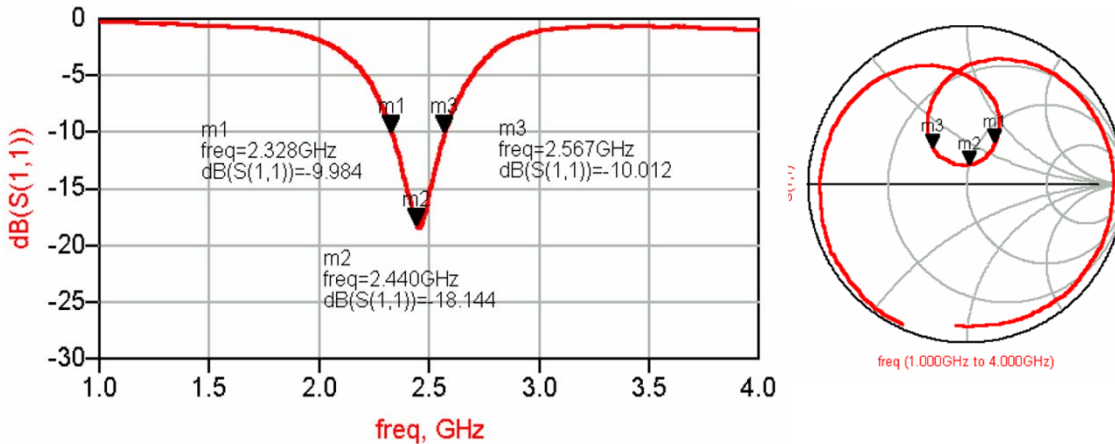

Johanson Technology, Inc. reserves the right to make design changes without notice.
All sales are subject to Johanson Technology, Inc. terms and conditions.



www.johansontechnology.com
4001 Calle Tecate • Camarillo, CA 93012 • TEL 805.389.1166 FAX 805.389.1821

Ver 3.1

2016 Johanson Technology, Inc. All Rights Reserved

"High Frequency Ceramic Solutions"

2.45 GHz High Gain SMD Chip Antenna

P/N 2450AT45A100

Detail Specification: 11/7/2016

Page 6 of 10

Typical Radiation Patterns for Mounting Considerations 2 - "Horizontal Orientation Type A" (@25C)

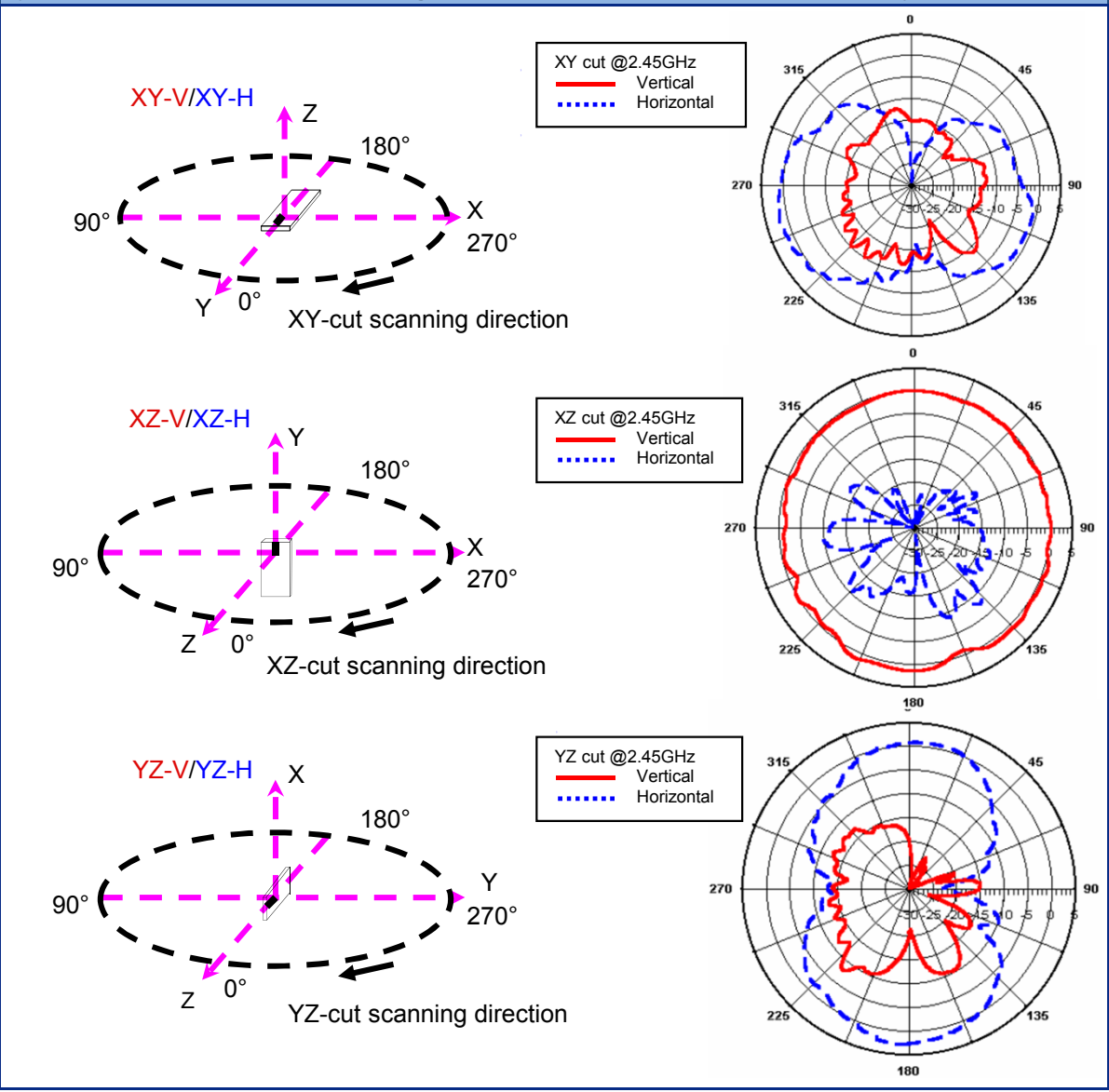

Johanson Technology, Inc. reserves the right to make design changes without notice.
 All sales are subject to Johanson Technology, Inc. terms and conditions.



www.johansontechnology.com
 4001 Calle Tecate • Camarillo, CA 93012 • TEL 805.389.1166 FAX 805.389.1821
 Ver 3.1 2016 Johanson Technology, Inc. All Rights Reserved

"High Frequency Ceramic Solutions"

2.45 GHz High Gain SMD Chip Antenna

P/N 2450AT45A100

Detail Specification: 11/7/2016

Page 7 of 10

Typical Electrical Specs for Mounting Considerations 3 - "Horizontal Orientation Type B" (T=25°C)

Frequency Range	2400 - 2500 Mhz	Peak Gain	1.3 dBi typ. (XZ-V)
Return Loss	9.5 dB min.	Average Gain	0.6 dBi typ. (XZ-V)

Mounting Considerations 3 - "Horizontal Orientation Type B"

Mount these devices with brown mark facing up. Units: mm

* Line width should be designed to provide 50Ω impedance matching characteristics.

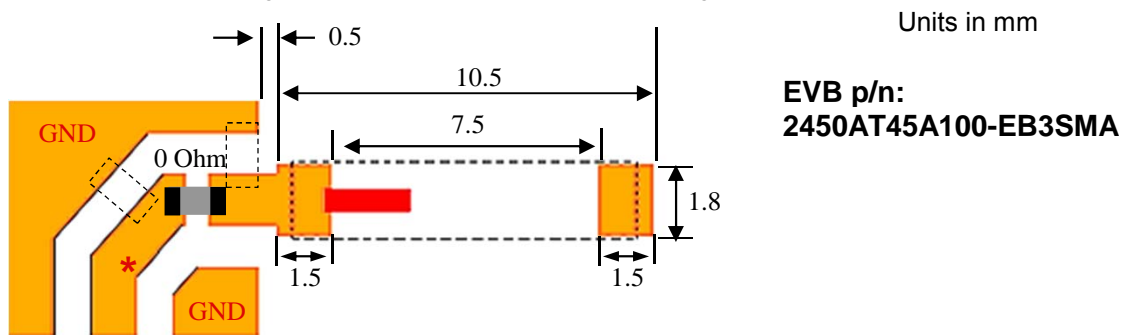

Note: It is recommended that the designer leave available slots for a "pi" (or shunt-series-shunt) network. The antenna matching network values above are used when antenna is mounted on Johanson's evaluation board. The matching values on client's PCB will be different, go to: <http://johansontechnology.com/tuning> and see how to obtain the new values. If you need further help, contact our RF Applications Eng Team at: <http://www.johansontechnology.com/ask-a-question>

Johanson Technology, Inc. reserves the right to make design changes without notice.
All sales are subject to Johanson Technology, Inc. terms and conditions.



www.johansontechnology.com
4001 Calle Tecate • Camarillo, CA 93012 • TEL 805.389.1166 FAX 805.389.1821

Ver 3.1

2016 Johanson Technology, Inc. All Rights Reserved

"High Frequency Ceramic Solutions"

2.45 GHz High Gain SMD Chip Antenna

P/N 2450AT45A100

Detail Specification: 11/7/2016

Page 8 of 10

Typical Electrical Characteristics Mounting Considerations 3 - "Horizontal Orientation Type B" (T=25°C)

Test Board
EVb p/n:
2450AT45A100-EB3SMA

Want the layout file of this? Send us a message at:
www.johansontechnology.com/ask-a-question

Let us help you design this antenna to your PCB and/or optimize your layout for best radiated performance. Send us a message by clicking on the link

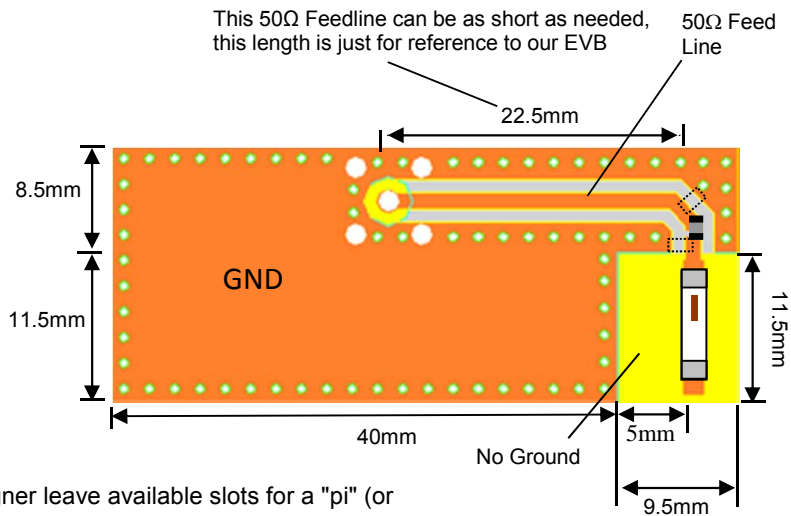

It is recommended that the designer leave available slots for a "pi" (or shunt-series-shunt) network

Return Loss

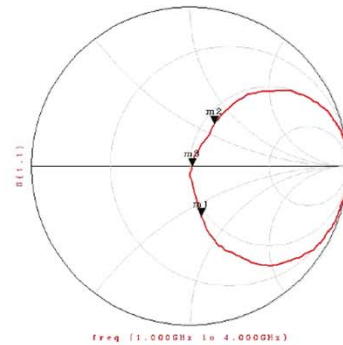
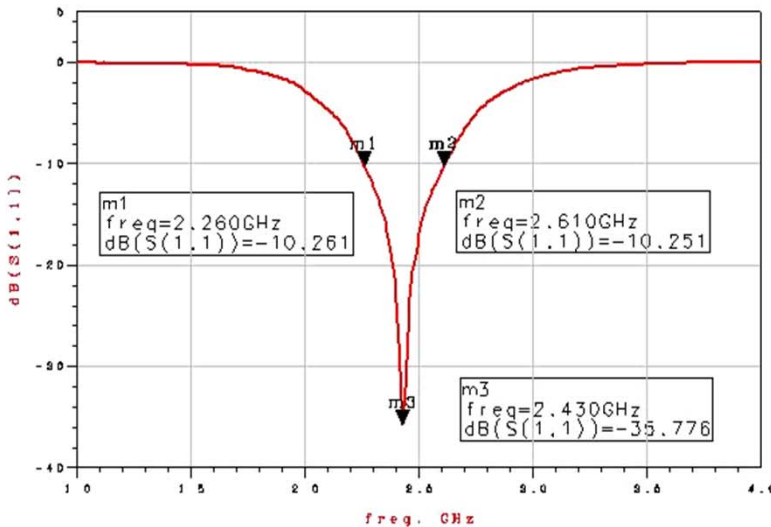

Johanson Technology, Inc. reserves the right to make design changes without notice.
 All sales are subject to Johanson Technology, Inc. terms and conditions.



www.johansontechnology.com

4001 Calle Tecate • Camarillo, CA 93012 • TEL 805.389.1166 FAX 805.389.1821

Ver 3.1

2016 Johanson Technology, Inc. All Rights Reserved

"High Frequency Ceramic Solutions"

2.45 GHz High Gain SMD Chip Antenna

P/N 2450AT45A100

Detail Specification: 11/7/2016

Page 9 of 10

Typical Radiation Patterns for Mounting Considerations 3 - "Horizontal Orientation Type B" (@25C)

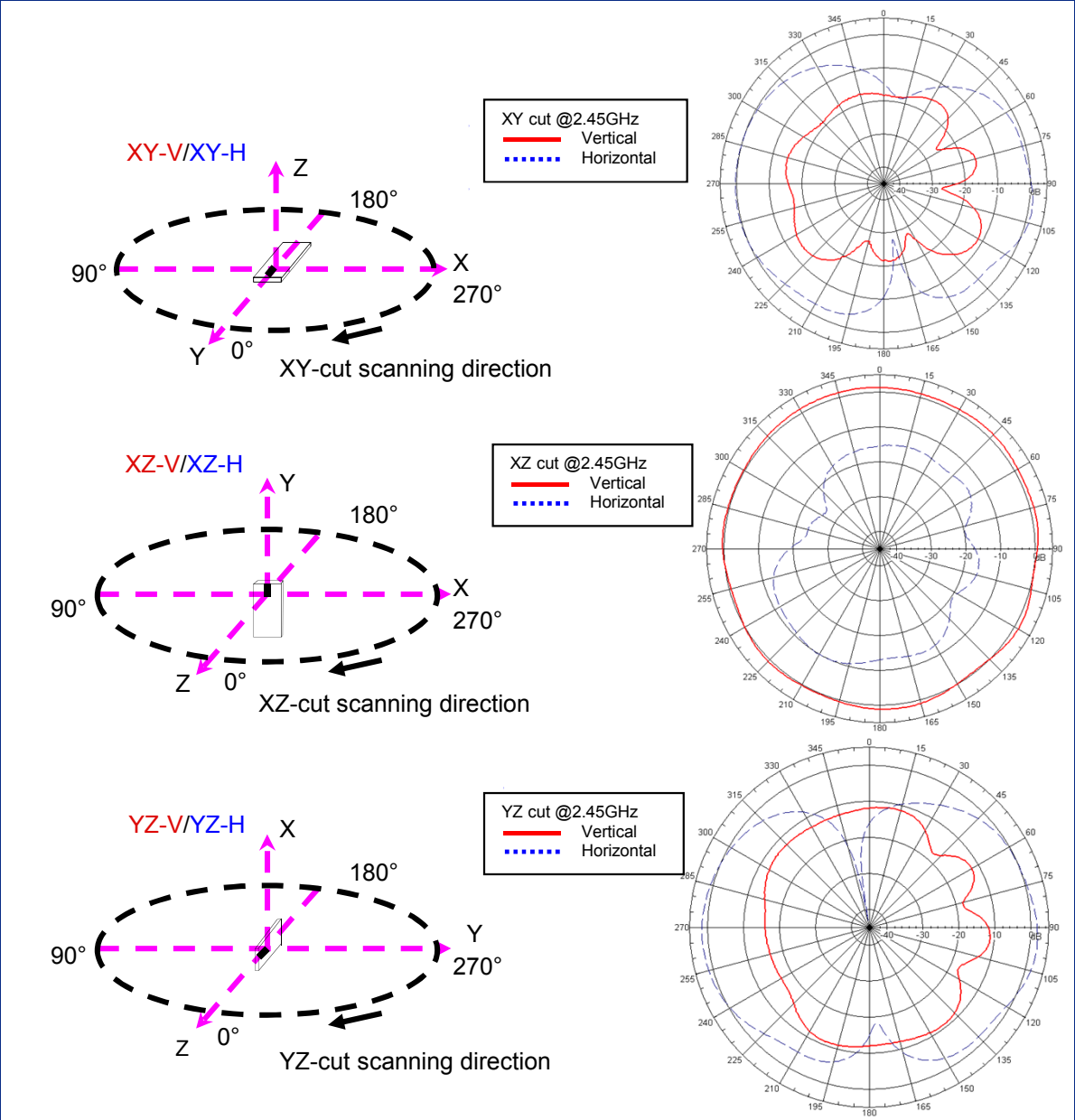

Johanson Technology, Inc. reserves the right to make design changes without notice.

All sales are subject to Johanson Technology, Inc. terms and conditions.



www.johansontechnology.com
4001 Calle Tecate • Camarillo, CA 93012 • TEL 805.389.1166 FAX 805.389.1821

Ver 3.1

2016 Johanson Technology, Inc. All Rights Reserved

"High Frequency Ceramic Solutions"

2.45 GHz High Gain SMD Chip Antenna

P/N 2450AT45A100

Detail Specification: 11/7/2016

Page 10 of 10

Antenna layout review, tuning, and characterization services

www.johansontechnology.com/ipc-antenna-services

More SMD Chip Antennas at:

www.johansontechnology.com/antennas

Antenna layout and tuning techniques (How to obtain the new antenna matching values)

www.johansontechnology.com/tuning

Packaging information

<http://www.johansontechnology.com/tape-reel-packaging>

Soldering Information

www.johansontechnology.com/ipcsoldering-profile

RoHS Compliance

www.johansontechnology.com/rohs-compliance

Recommended Storage Conditions and Shelf Life of unused product still on T&R or Bulk

Temperature	+5C to +35°C	Shelf Life	18 months max.
Relative Humidity	45 to 75%		

Johanson Technology, Inc. reserves the right to make design changes without notice.
All sales are subject to Johanson Technology, Inc. terms and conditions.



www.johansontechnology.com

4001 Calle Tecate • Camarillo, CA 93012 • TEL 805.389.1166 FAX 805.389.1821

Ver 3.1

2016 Johanson Technology, Inc. All Rights Reserved