

FINISH TYPE	"0" TIN	"1" 15MICROINCH GOLD	"2" 30MICROINCH GOLD				
CKT	HDR ASSY PN	HDR ASSY PN	HDR ASSY PN	A	B	C	D
2	2189890220	2189890221	2189890222	9.65	3.00	14.20	2.95
3	2189890320	2189890321	2189890322	12.65	6.00	17.20	2.95
4	2189890420	2189890421	2189890422	15.65	9.00	20.20	7.70
5	2189890520	2189890521	2189890522	18.65	12.00	23.20	10.70

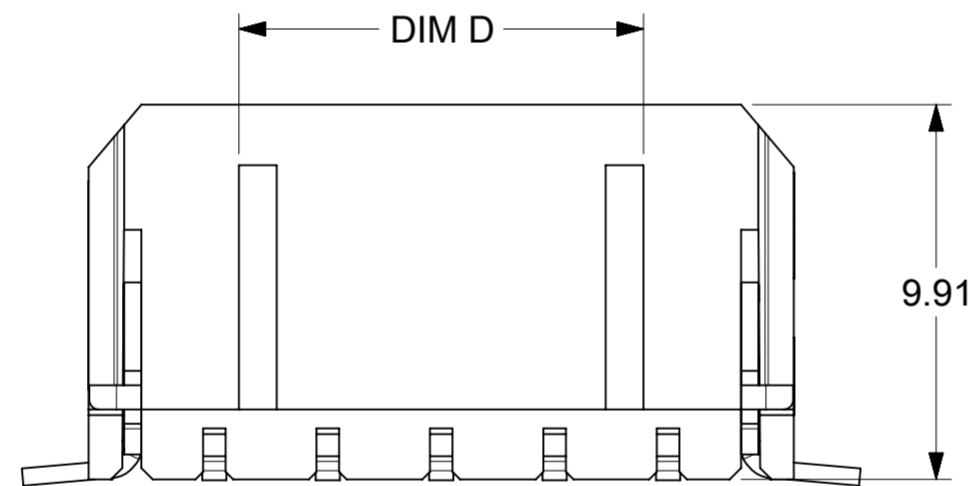
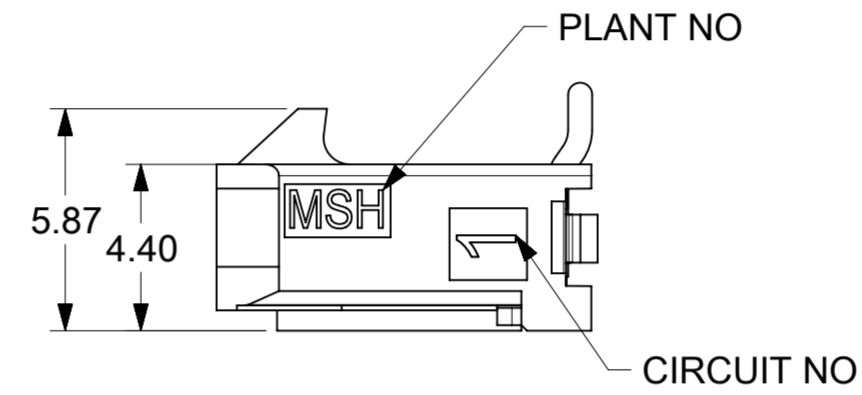
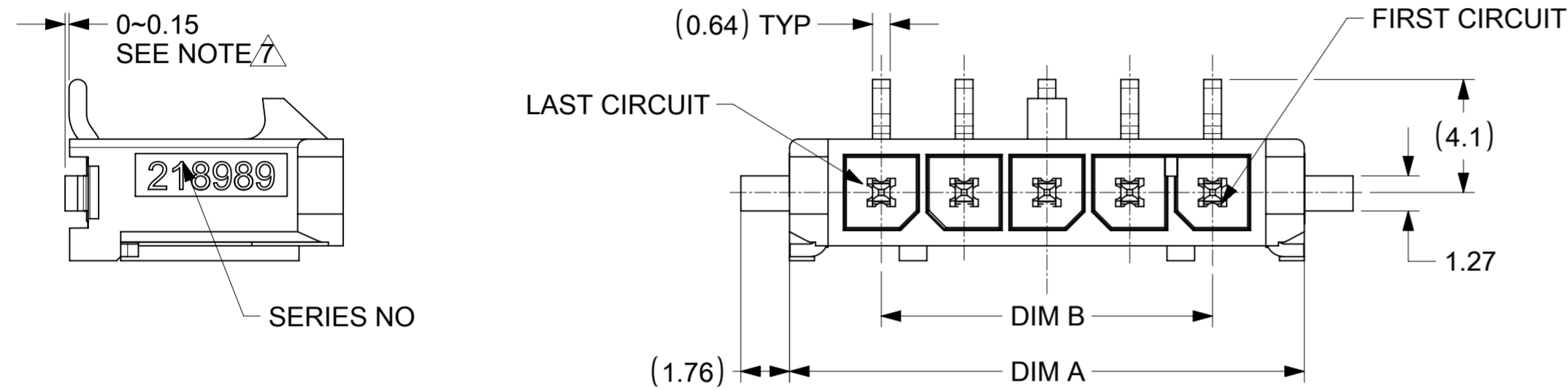

NOTES:

- HOSING MATERIAL: GLASS FILLED LIQUID CRYSTAL POLYMER, UL 94V-0, COLOR: BLACK
TERMINAL MATERIAL: HIGH COPPER ALLOY
- FINISH:
OPTION "0": REFLOW MATTE TIN OVER NICKEL
OPTION "1": SELECT 15MICROINCH GOLD AND SELECT MATTE TIN OVER NICKEL.
OPTION "2": SELECT 30MICROINCH GOLD AND SELECT MATTE TIN OVER NICKEL.
- PRODUCT SPECIFICATION : 2064600000-PS
- PRODUCT TEST SUMMARY: 2064600000-TS
- T&R PACK : 2189890001-PK
- MATE WITH RECEPTACLE 215759
- THE COPLANARITY DIMENSION IS ESTABLISHED BY PLACING THE ASSEMBLY ON A FLAT SURFACE. THE DISTANCE FROM THAT SURFACE TO THE BOTTOM OF ANY TERMINAL OR NAIL MUST NOT EXCEED 0.15
- THIS PART CONFORMS TO CLASS 'B' REQUIREMENTS OF COSMETIC SPECIFICATION PS-45499-002.

LEGEND

218989 - * * * *

SERIES NO. _____

CKT NO. _____

OPTION

0: RIGHT ANGLE WITH NAIL

1: RIGHT ANGLE WITH CLIP

2: VERTICAL WITH NAIL

3: VERTICAL WITH CLIP

PLATING OPTION

0: TIN

1: 15MICROINCH AU

2: 30MICROINCH AU

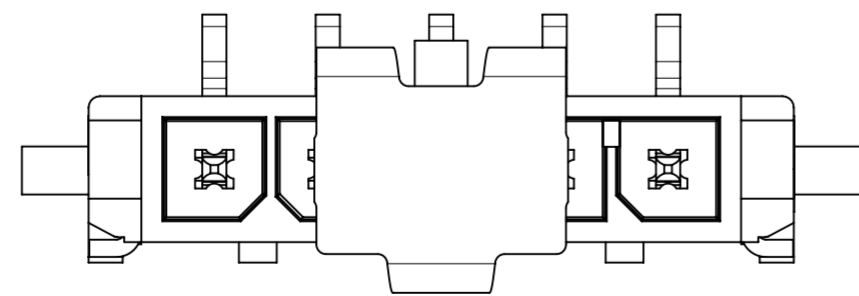

THIS DRAWING CONTAINS INFORMATION THAT IS PROPRIETARY TO MOLEX ELECTRONIC TECHNOLOGIES, LLC AND SHOULD NOT BE USED WITHOUT WRITTEN PERMISSION									
DIMENSION UNITS	SCALE	CURRENT REV DESC:							
mm	NTS								
GENERAL TOLERANCES (UNLESS SPECIFIED)					MICRO-FIT + SINGLE ROW VERTICAL SMT HEADER WITH NAIL				
ANGULAR TOL	± 3.0°								
4 PLACES	±	EC NO: 724761	2022/09/08	PRODUCT CUSTOMER DRAWING					
3 PLACES	±	DRWN: ZIXUAQ	2022/10/17						
2 PLACES	± 0.25	CHK'D: XQZHANG	2022/10/17	DOCUMENT NUMBER					
1 PLACE	± 0.36	APPR: XQZHANG	2022/10/17						
0 PLACES	±	INITIAL REVISION:		2189890020-SD		DOC TYPE	DOC PART	REVISION	
DRAFT WHERE APPLICABLE MUST REMAIN WITHIN DIMENSIONS		DRWN: ZIXUAQ	2022/09/08	SEE TABLE		PSD	000	A	
THIRD ANGLE PROJECTION		APPR: XQZHANG	2022/10/17	GENERAL MARKET				SHEET NUMBER	
DRAWING		SERIES		MATERIAL NUMBER		CUSTOMER		1 OF 2	
A2-SIZE		218989		SEE TABLE		GENERAL MARKET		1 OF 2	

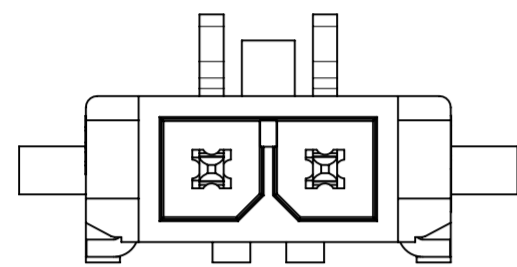

2CKT

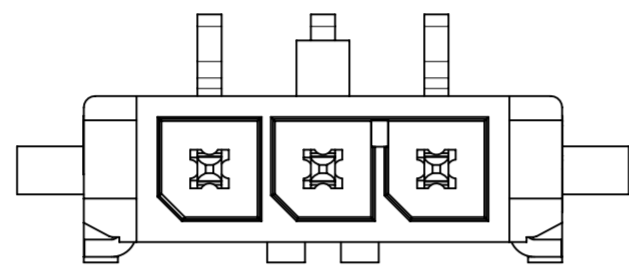

3CKT

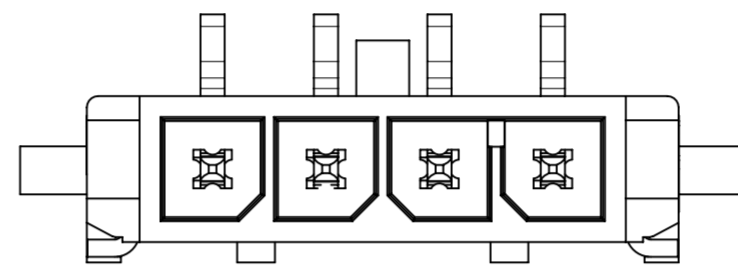

4CKT

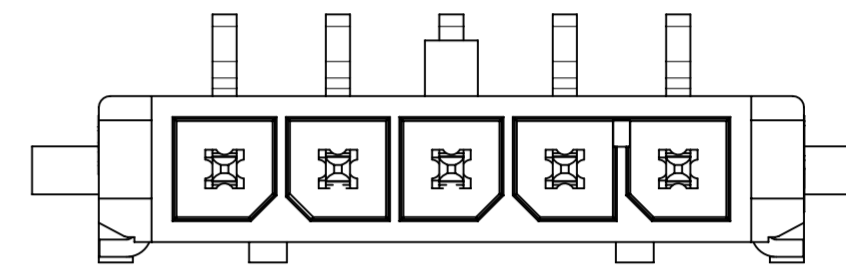

5CKT

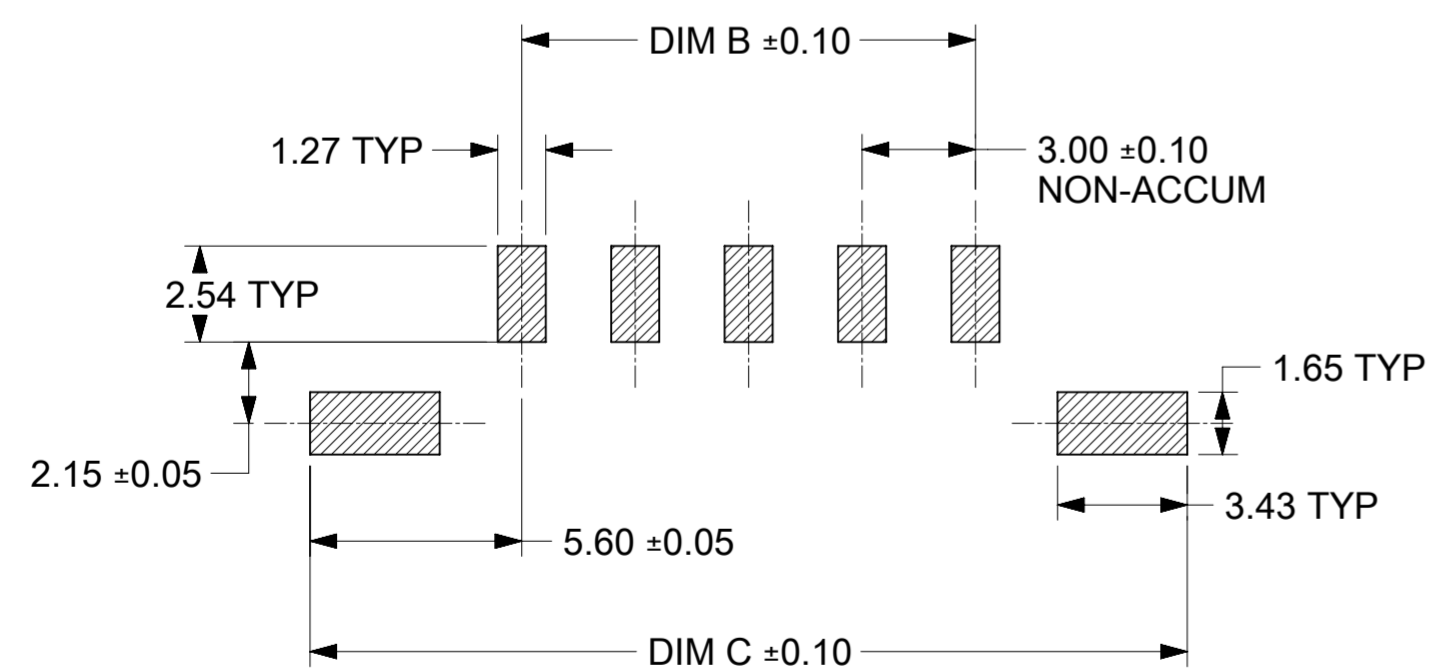

PCB LAYOUT: COMPONENT SIDE
 RECOMMEND PCB THICKNESS: 1.60 \pm 0.05MM

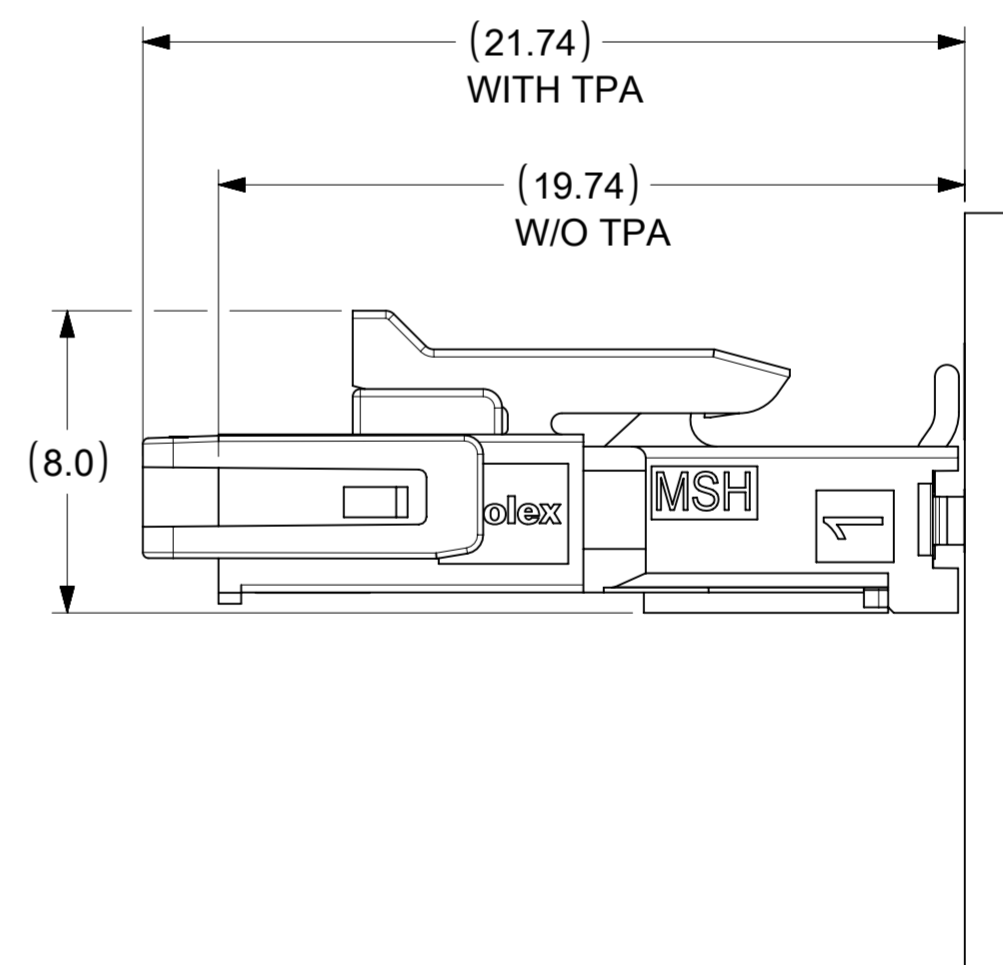

THIS DRAWING CONTAINS INFORMATION THAT IS PROPRIETARY TO MOLEX ELECTRONIC TECHNOLOGIES, LLC AND SHOULD NOT BE USED WITHOUT WRITTEN PERMISSION									
DIMENSION UNITS	SCALE	CURRENT REV DESC:							
mm	NTS								
GENERAL TOLERANCES (UNLESS SPECIFIED)					MICRO-FIT + SINGLE ROW VERTICAL SMT HEADER WITH NAIL				
ANGULAR TOL	\pm	3.0°							
4 PLACES	\pm		EC NO: 724761	2022/09/08	PRODUCT CUSTOMER DRAWING				
3 PLACES	\pm		DRWN: ZIXUAQ	2022/10/17					
2 PLACES	\pm	0.25	CHK'D: XQZHANG	2022/10/17	2189890020-SD				
1 PLACE	\pm	0.36	APPR: XQZHANG	2022/10/17					
0 PLACES	\pm		INITIAL REVISION:		DOCUMENT NUMBER	DOC TYPE	DOC PART	REVISION	
DRAFT WHERE APPLICABLE MUST REMAIN WITHIN DIMENSIONS		THIRD ANGLE PROJECTION	DRAWING	SERIES	MATERIAL NUMBER	CUSTOMER	SHEET NUMBER		
			A2-SIZE	218989	SEE TABLE	GENERAL MARKET	2 OF 2		