



RF Power LDMOS Transistors

High Ruggedness N-Channel Enhancement-Mode Lateral MOSFETs

These high ruggedness devices are designed for use in high VSWR industrial, medical, broadcast, aerospace and mobile radio applications. Their unmatched input and output design supports frequency use from 1.8 to 400 MHz.

Typical Performance

Frequency (MHz)	Signal Type	V _{DD} (V)	P _{out} (W)	G _{ps} (dB)	η _D (%)
87.5–108 (1,2)	CW	62	680 CW	21.3	83.0
230 (3)	Pulse (100 μsec, 20% Duty Cycle)	65	600 Peak	26.4	74.4

Load Mismatch/Ruggedness

Frequency (MHz)	Signal Type	VSWR	P _{in} (W)	Test Voltage	Result
230 (3)	Pulse (100 μsec, 20% Duty Cycle)	> 65:1 at all Phase Angles	2.5 Peak (3 dB Overdrive)	65	No Device Degradation

1. Measured in 87.5–108 MHz broadband reference circuit (page 5).
2. The values shown are the center band performance numbers across the indicated frequency range.
3. Measured in 230 MHz production test fixture (page 10).

Features

- Unmatched input and output allowing wide frequency range utilization
- Output impedance fits a 4:1 transformer
- Device can be used single-ended or in a push-pull configuration
- Qualified up to a maximum of 65 V_{DD} operation
- Characterized from 30 to 65 V for extended power range
- High breakdown voltage for enhanced reliability
- Suitable for linear application with appropriate biasing
- Integrated ESD protection with greater negative gate-source voltage range for improved Class C operation
- Included in NXP product longevity program with assured supply for a minimum of 15 years after launch

Typical Applications

- Industrial, scientific, medical (ISM)
 - Laser generation
 - Plasma generation
 - Particle accelerators
 - MRI, RF ablation and skin treatment
 - Industrial heating, welding and drying systems
- Radio and VHF TV broadcast
- Aerospace
 - HF communications
 - Radar
- Mobile radio
 - HF and VHF communications
 - PMR base stations

MRFX600H
MRFX600HS
MRFX600GS

1.8–400 MHz, 600 W CW, 65 V
WIDEBAND
RF POWER LDMOS TRANSISTORS

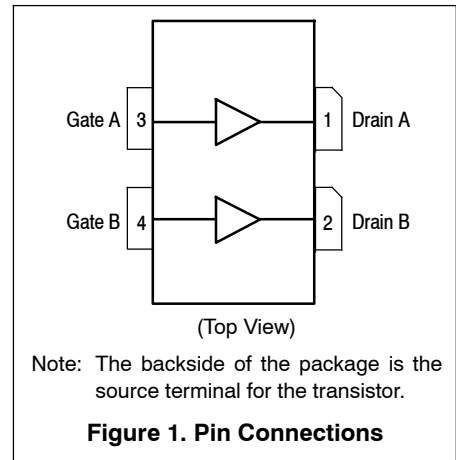
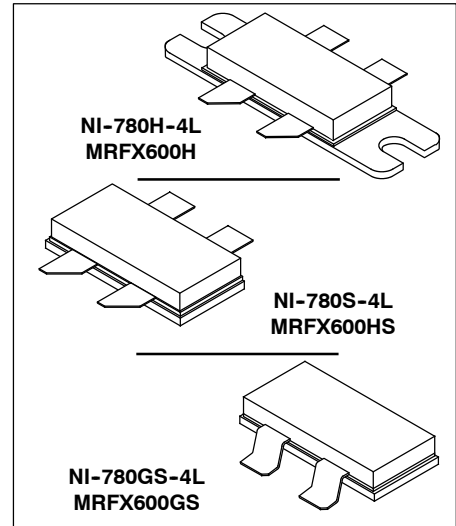

Table 1. Maximum Ratings

Rating	Symbol	Value	Unit
Drain-Source Voltage	V_{DSS}	-0.5, +179	Vdc
Gate-Source Voltage	V_{GS}	-6.0, +10	Vdc
Storage Temperature Range	T_{stg}	-65 to +150	°C
Case Operating Temperature Range	T_C	-40 to +150	°C
Operating Junction Temperature Range (1,2)	T_J	-40 to +225	°C
Total Device Dissipation @ $T_C = 25^\circ\text{C}$ Derate above 25°C	P_D	1333 6.67	W W/°C

Table 2. Thermal Characteristics

Characteristic	Symbol	Value (2,3)	Unit
Thermal Resistance, Junction to Case CW: Case Temperature 75°C, 650 W CW, 62 Vdc, $I_{DQ(A+B)} = 250$ mA, 98 MHz	$R_{\theta JC}$	0.15	°C/W
Thermal Impedance, Junction to Case Pulse: Case Temperature 73°C, 600 W Peak, 100 μsec Pulse Width, 20% Duty Cycle, 65 Vdc, $I_{DQ(A+B)} = 100$ mA, 230 MHz	$Z_{\theta JC}$	0.037	°C/W

Table 3. ESD Protection Characteristics

Test Methodology	Class
Human Body Model (per JS-001-2017)	Class 2, passes 2500 V
Charge Device Model (per JS-002-2014)	Class C3, passes 1000 V

Table 4. Electrical Characteristics ($T_A = 25^\circ\text{C}$ unless otherwise noted)

Characteristic	Symbol	Min	Typ	Max	Unit
----------------	--------	-----	-----	-----	------

Off Characteristics (4)

Gate-Source Leakage Current ($V_{GS} = 5$ Vdc, $V_{DS} = 0$ Vdc)	I_{GSS}	—	—	1	μAdc
Drain-Source Breakdown Voltage ($V_{GS} = 0$ Vdc, $I_D = 100$ mAdc)	$V_{(BR)DSS}$	179	193	—	Vdc
Zero Gate Voltage Drain Leakage Current ($V_{DS} = 65$ Vdc, $V_{GS} = 0$ Vdc)	I_{DSS}	—	—	10	μAdc
Zero Gate Voltage Drain Leakage Current ($V_{DS} = 179$ Vdc, $V_{GS} = 0$ Vdc)	I_{DSS}	—	—	100	μAdc

On Characteristics

Gate Threshold Voltage (4) ($V_{DS} = 10$ Vdc, $I_D = 277$ μAdc)	$V_{GS(th)}$	2.1	2.5	2.9	Vdc
Gate Quiescent Voltage ($V_{DD} = 65$ Vdc, $I_D = 100$ mAdc, Measured in Functional Test)	$V_{GS(Q)}$	2.7	2.9	3.2	Vdc
Drain-Source On-Voltage (4) ($V_{GS} = 10$ Vdc, $I_D = 0.74$ Adc)	$V_{DS(on)}$	—	0.2	—	Vdc
Forward Transconductance (4) ($V_{DS} = 10$ Vdc, $I_D = 32$ Adc)	g_{fs}	—	33.6	—	S

1. Continuous use at maximum temperature will affect MTTF.
2. MTTF calculator available at <http://www.nxp.com/RF/calculators>.
3. Refer to AN1955, *Thermal Measurement Methodology of RF Power Amplifiers*. Go to <http://www.nxp.com/RF> and search for AN1955.
4. Each side of device measured separately.

(continued)

Table 4. Electrical Characteristics ($T_A = 25^\circ\text{C}$ unless otherwise noted) (continued)

Characteristic	Symbol	Min	Typ	Max	Unit
Dynamic Characteristics ⁽¹⁾					
Reverse Transfer Capacitance ($V_{DS} = 65\text{ Vdc} \pm 30\text{ mV(rms)ac}$ @ 1 MHz, $V_{GS} = 0\text{ Vdc}$)	C_{rss}	—	1.1	—	pF
Output Capacitance ($V_{DS} = 65\text{ Vdc} \pm 30\text{ mV(rms)ac}$ @ 1 MHz, $V_{GS} = 0\text{ Vdc}$)	C_{oss}	—	84	—	pF
Input Capacitance ($V_{DS} = 65\text{ Vdc}$, $V_{GS} = 0\text{ Vdc} \pm 30\text{ mV(rms)ac}$ @ 1 MHz)	C_{iss}	—	299	—	pF

Functional Tests ⁽²⁾ (In NXP Production Test Fixture, 50 ohm system) $V_{DD} = 65\text{ Vdc}$, $I_{DQ(A+B)} = 100\text{ mA}$, $P_{out} = 600\text{ W Peak}$ (120 W Avg.), $f = 230\text{ MHz}$, 100 μsec Pulse Width, 20% Duty Cycle

Power Gain	G_{ps}	24.5	26.4	27.5	dB
Drain Efficiency	η_D	71.0	74.4	—	%
Input Return Loss	IRL	—	-23	-12	dB

Table 5. Load Mismatch/Ruggedness (In NXP Production Test Fixture, 50 ohm system) $I_{DQ(A+B)} = 100\text{ mA}$

Frequency (MHz)	Signal Type	VSWR	P_{in} (W)	Test Voltage, V_{DD}	Result
230	Pulse (100 μsec , 20% Duty Cycle)	> 65:1 at all Phase Angles	2.5 Peak (3 dB Overdrive)	65	No Device Degradation

Table 6. Ordering Information

Device	Tape and Reel Information	Package
MRFX600HR5	R5 Suffix = 50 Units, 56 mm Tape Width, 13-inch Reel	NI-780H-4L
MRFX600HSR5	R5 Suffix = 50 Units, 32 mm Tape Width, 13-inch Reel	NI-780S-4L
MRFX600GSR5		NI-780GS-4L

- Each side of device measured separately.
- Measurements made with device in straight lead configuration before any lead forming operation is applied. Lead forming is used for gull wing (GS) parts.

TYPICAL CHARACTERISTICS

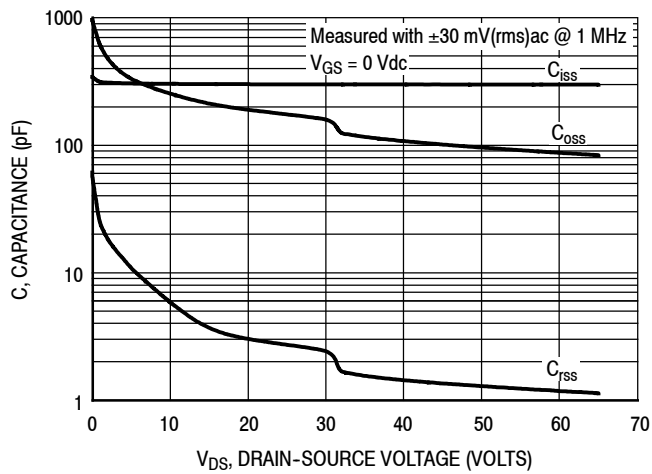

Note: Each side of device measured separately.

Figure 2. Capacitance versus Drain-Source Voltage

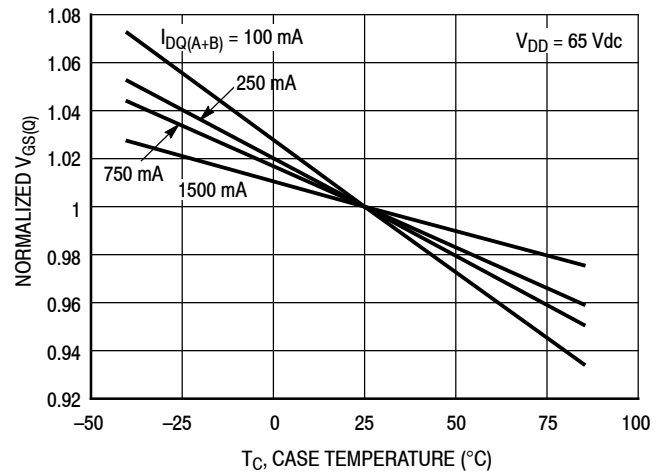

I_{DQ} (mA)	Slope (mV/ $^{\circ}$ C)
100	-3.20
250	-2.48
750	-2.16
1500	-1.36

Figure 3. Normalized V_{GS} versus Quiescent Current and Case Temperature

87.5–108 MHz BROADBAND REFERENCE CIRCUIT – 2.9" × 4.7" (7.3 cm × 12.0 cm)

Table 7. 87.5–108 MHz Broadband Performance (In NXP Reference Circuit, 50 ohm system)

$I_{DQ(A+B)} = 250 \text{ mA}$, $P_{in} = 5 \text{ W}$, CW

Frequency (MHz)	V_{DD} (V)	P_{out} (W)	G_{ps} (dB)	η_D (%)
87.5	62	705	21.5	80.0
98	62	680	21.3	83.0
108	62	650	21.2	82.5

87.5–108 MHz BROADBAND REFERENCE CIRCUIT — 2.9" × 4.7" (7.3 cm × 12 cm)

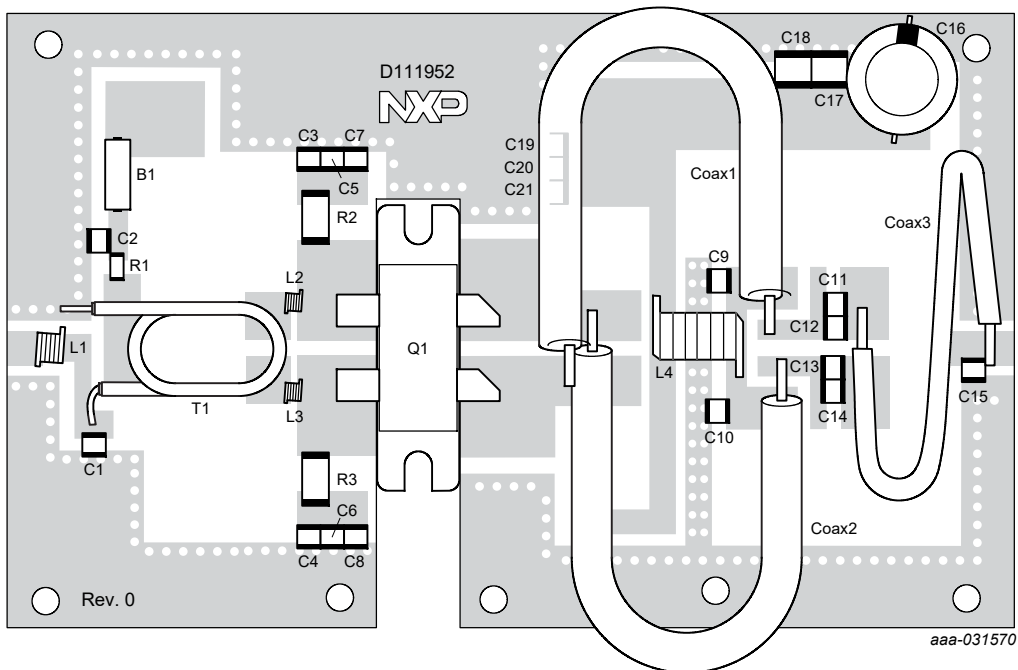

Figure 4. MRFX600H 87.5–108 MHz Broadband Reference Circuit Component Layout

Table 8. MRFX600H 87.5–108 MHz Broadband Reference Circuit Component Designations and Values

Part	Description	Part Number	Manufacturer
B1	Long Ferrite Bead	2743021447	Fair-Rite
C1	30 pF Chip Capacitor	ATC100B300JT500XT	ATC
C2, C5, C6, C9, C10, C11, C12, C13, C14	1000 pF Chip Capacitor	ATC100B102JT50XT	ATC
C3, C4	10,000 pF Chip Capacitor	ATC200B103KT50XT	ATC
C7, C8	470 pF Chip Capacitor	ATC100B471JT200XT	ATC
C15	1.0 pF Chip Capacitor	ATC100B1R0BT500XT	ATC
C16	470 μ F, 63 V Electrolytic Capacitor	MCGPR63V477M13X26	Multicomp
C17, C18	10 μ F Chip Capacitor	C5750X7S2A106M	TDK
C19	470 nF Chip Capacitor	GRM31MR72A474KA35L	Murata
C20	47 nF Chip Capacitor	GRM31MR72A473KA01L	Murata
C21	15 nF Chip Capacitor	C3225CH2A153JT	TDK
Coax1,2	35 Ω Flex Cable, 4.5" Shield Length	HSF-141C-35	Hongsen Cable
Coax3	50 Ω Flex Cable, 6.3" Shield Length	SM141	Huber + Suhner
L1	100 nH Inductor	1812SMS-R10JLC	Coilcraft
L2, L3	8.0 nH, 3 Turn Inductor	A03TJLC	Coilcraft
L4	5 Turn, #16 AWG, ID = 0.315" Inductor	Handwound	NXP
Q1	RF Power LDMOS Transistor	MRFX600H	NXP
R1	10 Ω , 1/4 W Chip Resistor	CRCW120610R0JNEA	Vishay
R2, R3	33 Ω , 2 W Chip Resistor	352133RFT	TE Connectivity
T1	2–300 MHz, 3 Turns, 9:1 Impedance Ratio Transformer	TUI-LF-9	Communication Concepts
PCB	Rogers RO4350B, 0.030", $\epsilon_r = 3.66$	D111952	MTL

MRFX600H MRFX600HS MRFX600GS

TYPICAL CHARACTERISTICS – 87.5–108 MHz BROADBAND REFERENCE CIRCUIT

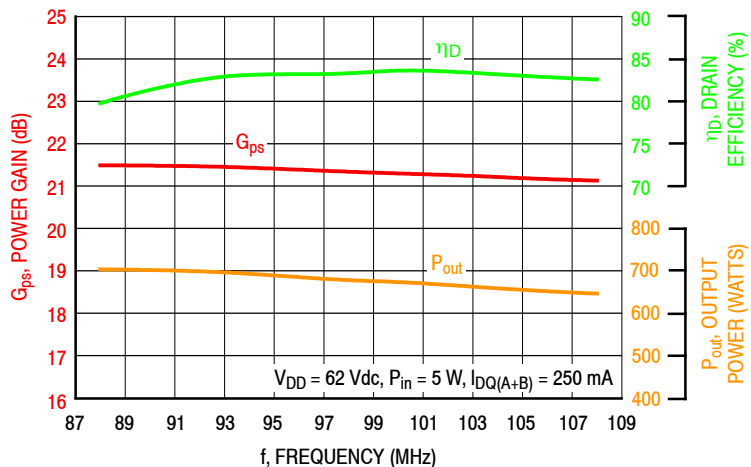

Figure 5. Power Gain, Drain Efficiency and CW Output Power versus Frequency at a Constant Input Power

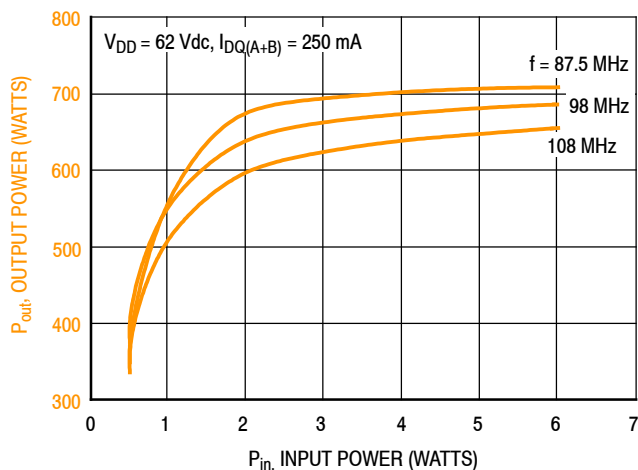

Figure 6. CW Output Power versus Input Power and Frequency

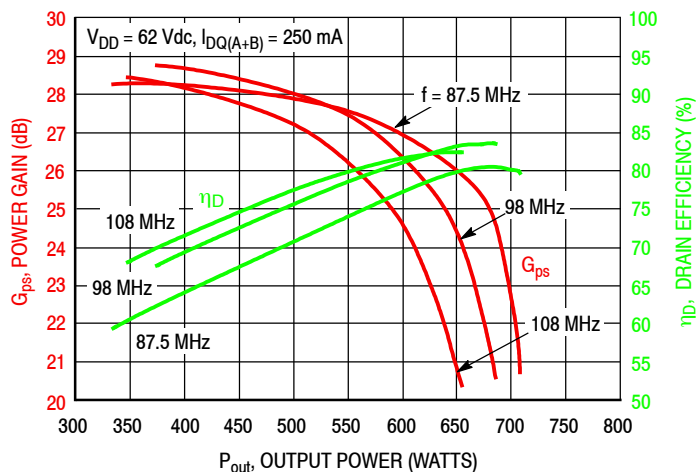

Figure 7. Power Gain and Drain Efficiency versus CW Output Power and Frequency

87.5–108 MHz BROADBAND REFERENCE CIRCUIT

f MHz	Z _{source} Ω	Z _{load} Ω
87.5	5.46 + j12.00	11.09 + j8.82
98	6.45 + j11.40	11.51 + j8.88
108	5.57 + j11.13	11.84 + j9.06

Z_{source} = Test circuit impedance as measured from gate to gate, balanced configuration.

Z_{load} = Test circuit impedance as measured from drain to drain, balanced configuration.

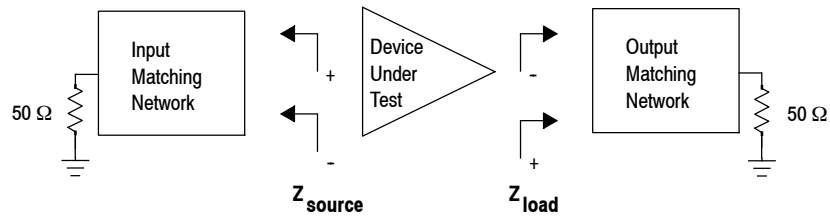

Figure 8. Broadband Series Equivalent Source and Load Impedance – 87.5–108 MHz

**HARMONIC MEASUREMENTS — 87.5–108 MHz
BROADBAND REFERENCE CIRCUIT**

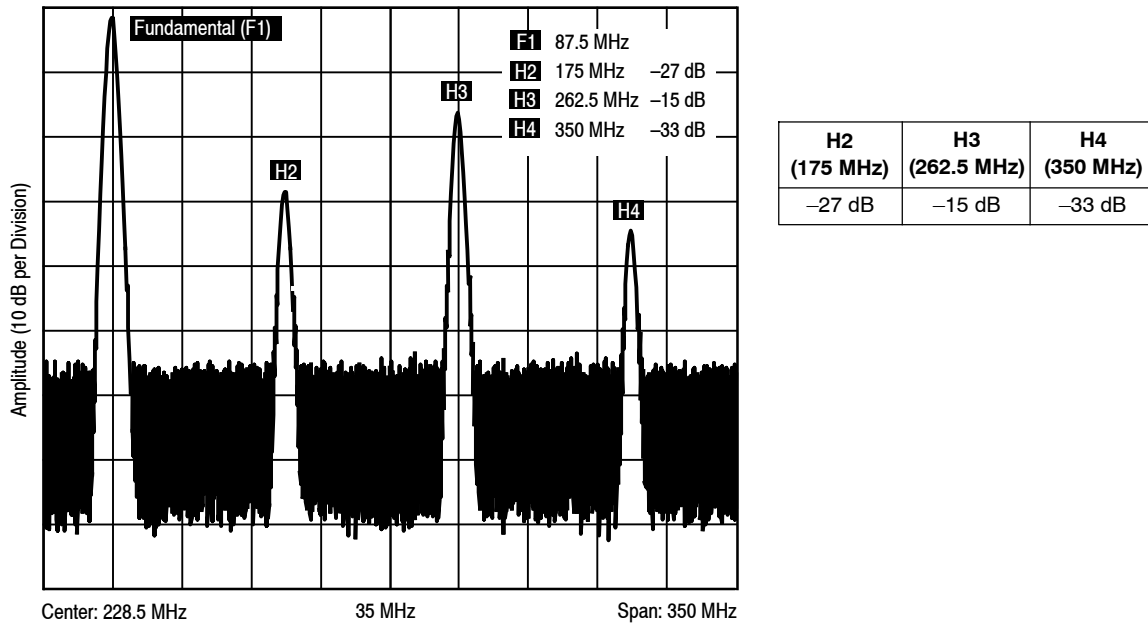

Figure 9. 87.5 MHz Harmonics @ 675 W CW

230 MHz PRODUCTION TEST FIXTURE — 4.0" x 6.0" (10.2 cm x 12.7 cm)

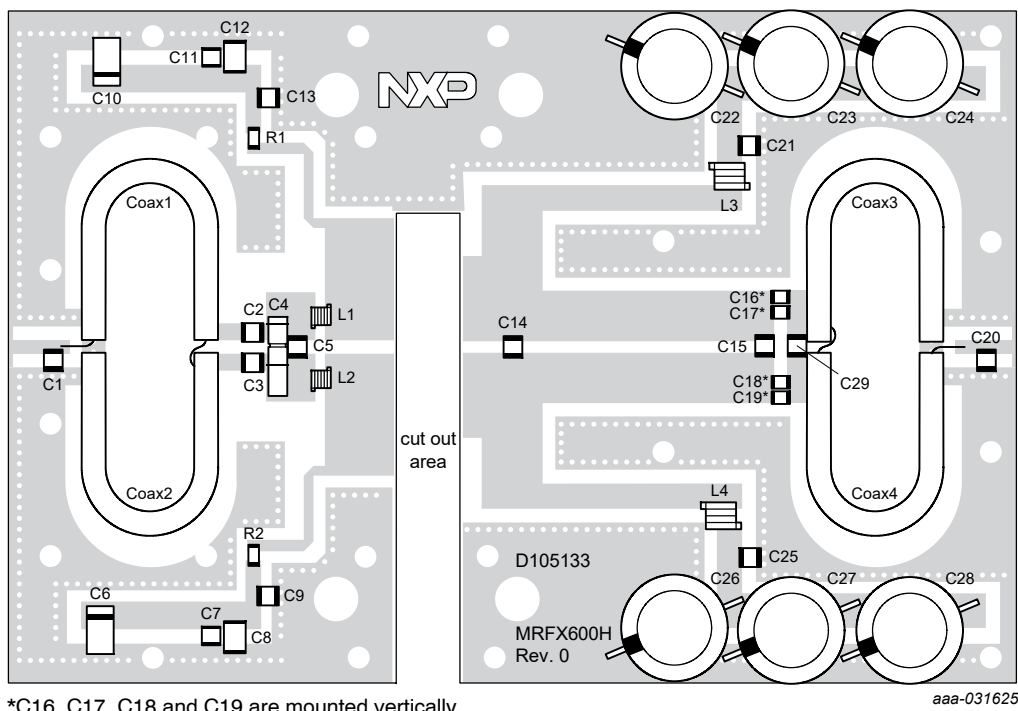

Figure 10. MRFX600H Production Test Fixture Component Layout — 230 MHz

Table 9. MRFX600H Production Test Fixture Component Designations and Values — 230 MHz

Part	Description	Part Number	Manufacturer
C1	13 pF Chip Capacitor	ATC100B130JT500XT	ATC
C2, C3	27 pF Chip Capacitor	ATC100B270JT500XT	ATC
C4	0.8–8.0 pF Variable Capacitor	27291SL	Johanson Components
C5	33 pF Chip Capacitor	ATC100B330JT500XT	ATC
C6, C10	22 μ F, 35 V Tantalum Capacitor	T491X226K035AT	Kemet
C7, C11	0.1 μ F Chip Capacitor	CDR33BX104AKWS	AVX
C8, C12	220 nF Chip Capacitor	C1812C224K5RACTU	Kemet
C9, C13, C21, C25	1000 pF Chip Capacitor	ATC100B102JT50XT	ATC
C14, C29	39 pF Chip Capacitor	ATC100B390JT500XT	ATC
C15	43 pF Chip Capacitor	ATC100B430JT500XT	ATC
C16, C17, C18, C19	240 pF Chip Capacitor	ATC100B241JT200XT	ATC
C20	9.1 pF Chip Capacitor	ATC100B9R1BT500XT	ATC
C22, C23, C24, C26, C27, C28	470 μ F, 100 V Electrolytic Capacitor	MCGPR100V477M16X32	Multicomp
Coax1, 2, 3, 4	25 Ω Semi-rigid Coax, 2.2" Shield Length	UT-141C-25	Micro-Coax
L1, L2	5 nH Inductor	A02TKLC	Coilcraft
L3, L4	6.6 nH Inductor	GA3093-ALC	Coilcraft
R1, R2	10 Ω , 1/4 W Chip Resistor	CRCW120610R0JNEA	Vishay
PCB	Rogers AD255C, 0.030", $\epsilon_r = 2.55$, 1 oz. Copper	D105133	MTL

**TYPICAL CHARACTERISTICS — 230 MHz, $T_C = 25^\circ\text{C}$
PRODUCTION TEST FIXTURE**

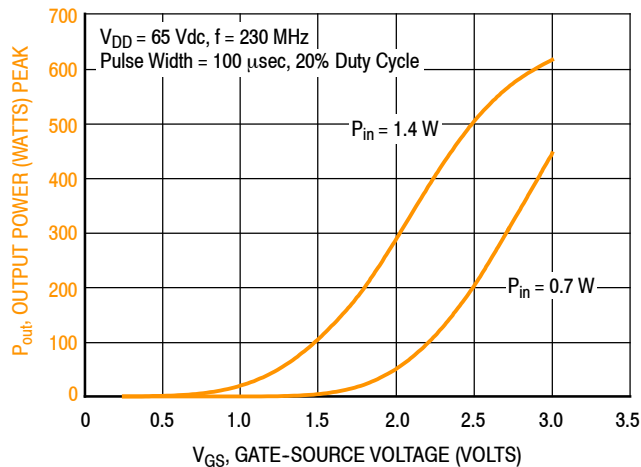
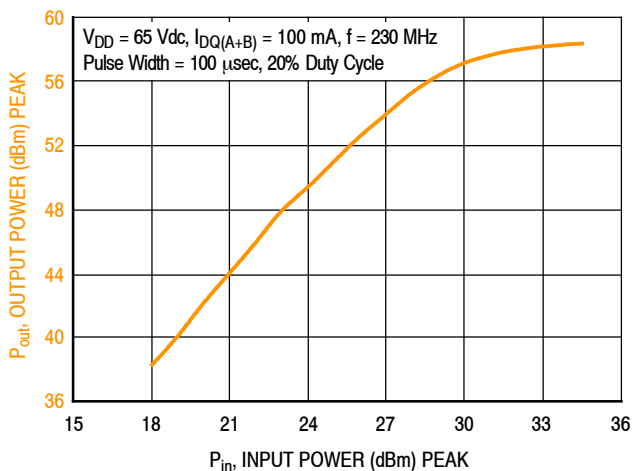

Figure 11. Output Power versus Gate-Source Voltage at a Constant Input Power



f (MHz)	P1dB (W)	P3dB (W)
230	610	677

Figure 12. Output Power versus Input Power

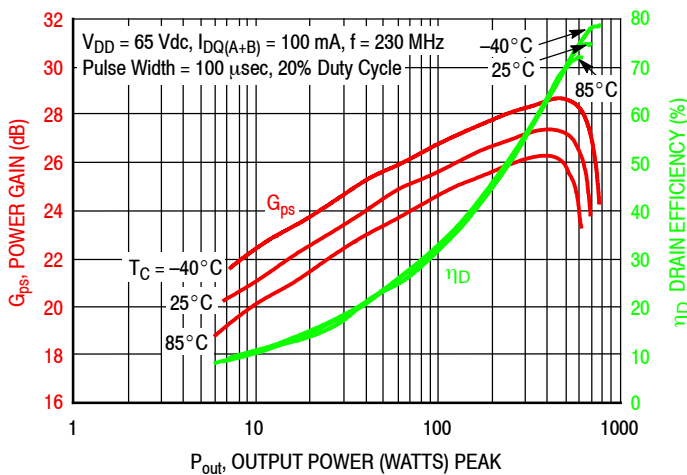

Figure 14. Power Gain and Drain Efficiency versus Output Power

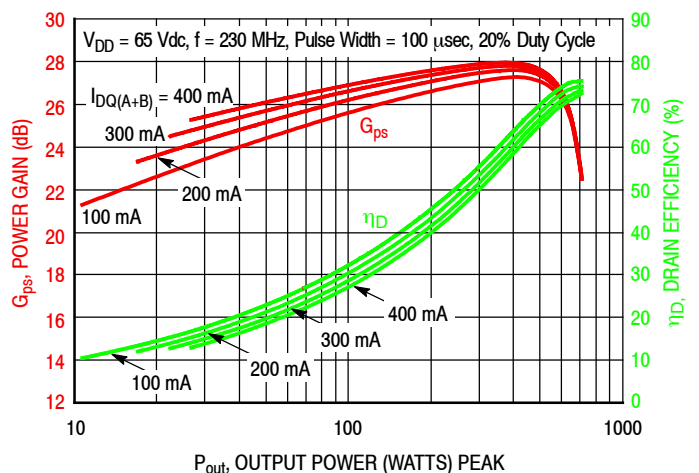

Figure 13. Power Gain and Drain Efficiency versus Output Power and Quiescent Current

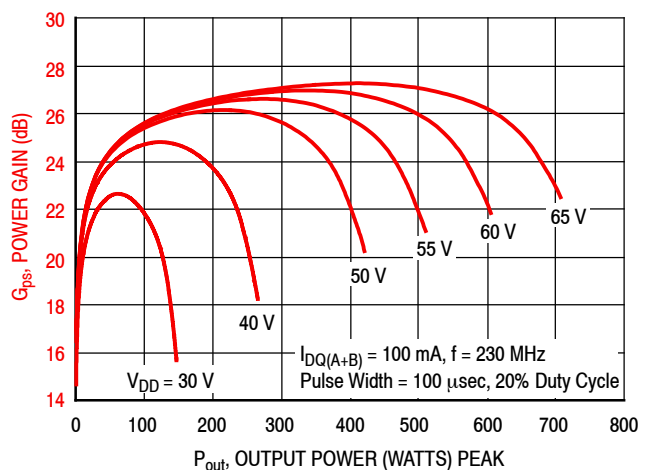

Figure 15. Power Gain versus Output Power and Drain-Source Voltage

MRFX600H MRFX600HS MRFX600GS

230 MHz PRODUCTION TEST FIXTURE

f MHz	Z _{source} Ω	Z _{load} Ω
230	1.5 + j4.9	5.0 + j7.1

Z_{source} = Test fixture impedance as measured from gate to gate, balanced configuration.

Z_{load} = Test fixture impedance as measured from drain to drain, balanced configuration.

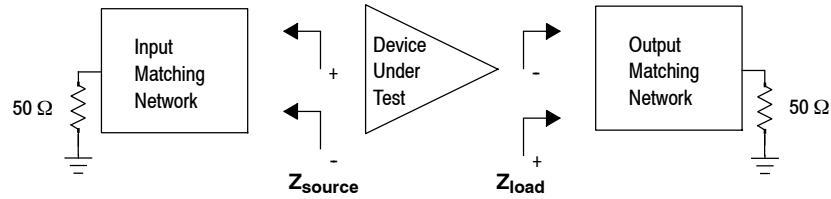
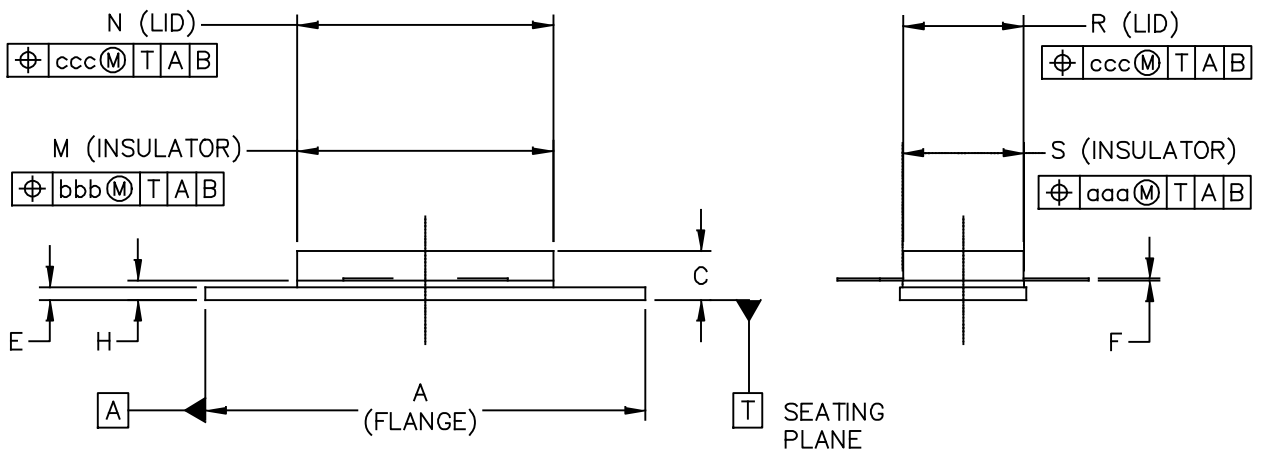
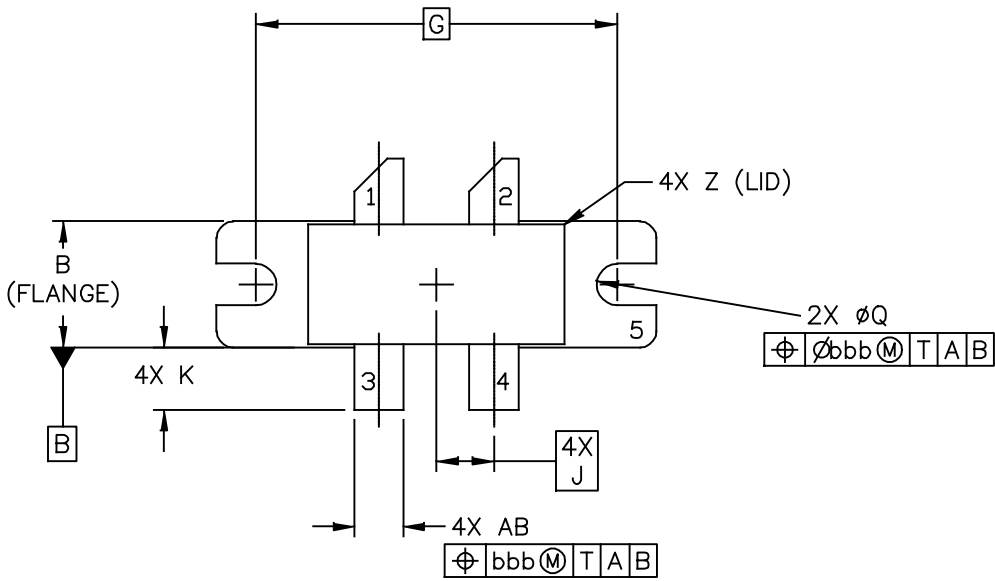

Figure 16. Series Equivalent Source and Load Impedance – 230 MHz

PACKAGE DIMENSIONS



© NXP SEMICONDUCTORS N.V. ALL RIGHTS RESERVED	MECHANICAL OUTLINE	PRINT VERSION NOT TO SCALE						
TITLE: <div style="text-align: center; font-size: 1.2em;">NI 780-4</div>	<table style="width: 100%; border-collapse: collapse;"> <tr> <td style="width: 60%;">DOCUMENT NO: 98ASA10793D</td> <td style="width: 40%;">REV: A</td> </tr> <tr> <td colspan="2">STANDARD: NON-JEDEC</td> </tr> <tr> <td>SOT1827-1</td> <td style="text-align: right;">17 MAR 2016</td> </tr> </table>		DOCUMENT NO: 98ASA10793D	REV: A	STANDARD: NON-JEDEC		SOT1827-1	17 MAR 2016
DOCUMENT NO: 98ASA10793D	REV: A							
STANDARD: NON-JEDEC								
SOT1827-1	17 MAR 2016							

NOTES:

1. DIMENSIONING AND TOLERANCING PER ANSI Y14.5M-1994.
2. CONTROLLING DIMENSION: INCH.
3. DIMENSION H IS MEASURED .030 (0.762) AWAY FROM PACKAGE BODY.

STYLE 1:

- PIN
1. DRAIN
 2. DRAIN
 3. GATE
 4. GATE
 5. SOURCE

DIM	INCH		MILLIMETER		DIM	INCH		MILLIMETER	
	MIN	MAX	MIN	MAX		MIN	MAX	MIN	MAX
A	1.335	1.345	33.91	34.16	R	.365	.375	9.27	9.53
B	.380	.390	9.65	9.91	S	.365	.375	9.27	9.52
C	.125	.170	3.18	4.32	U		.040		1.02
E	.035	.045	0.89	1.14	Z		.030		0.76
F	.003	.006	0.08	0.15	AB	.145	.155	3.68	3.94
G	1.100 BSC		27.94 BSC						
H	.057	.067	1.45	1.7	aaa		.005		0.127
J	.175 BSC		4.44 BSC		bbb		.010		0.254
K	.170	.210	4.32	5.33	ccc		.015		0.381
M	.774	.786	19.61	20.02					
N	.772	.788	19.61	20.02					
Q	ø.118	ø.138	ø3	ø3.51					
© NXP SEMICONDUCTORS N. V. ALL RIGHTS RESERVED			MECHANICAL OUTLINE			PRINT VERSION NOT TO SCALE			
TITLE: NI 780-4					DOCUMENT NO: 98ASA10793D REV: A				
					STANDARD: NON-JEDEC				
					SOT1827-1			17 MAR 2016	

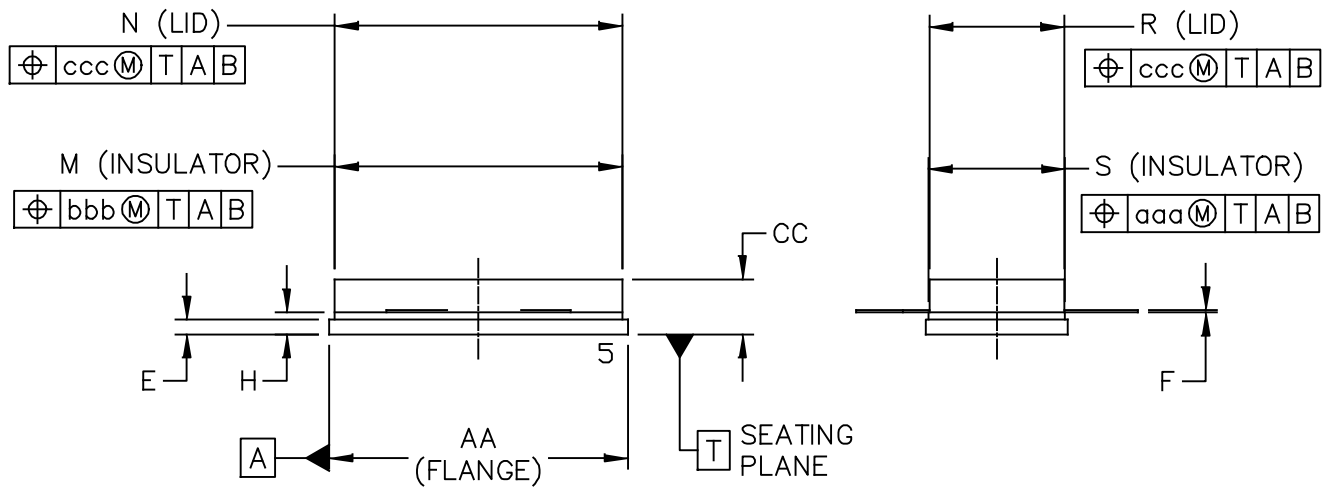
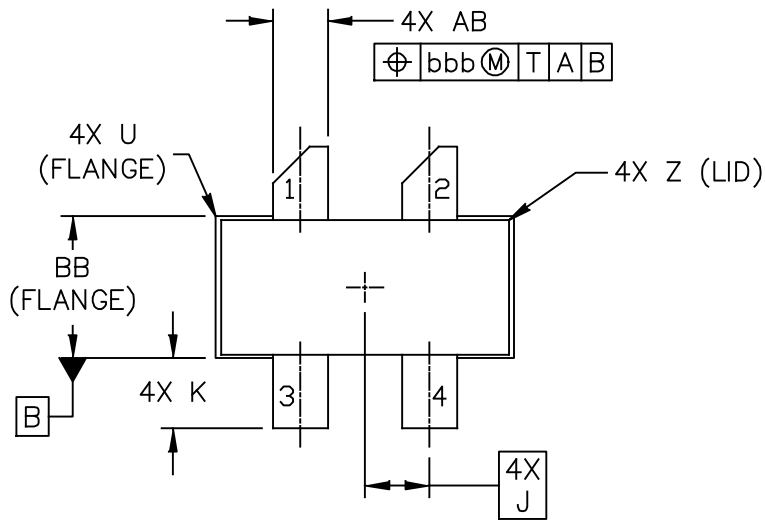

© NXP SEMICONDUCTORS N.V. ALL RIGHTS RESERVED	MECHANICAL OUTLINE	PRINT VERSION NOT TO SCALE
TITLE: NI-780S-4L	DOCUMENT NO: 98ASA10718D STANDARD: NON-JEDEC SOT1826-1	REV: C 01 AUG 2016

NOTES:

1. DIMENSIONING AND TOLERANCING PER ANSI Y14.5M-1994.
2. CONTROLLING DIMENSION: INCH.
3. DELETED
4. DIMENSION H IS MEASURED .030 (0.762) AWAY FROM FLANGE TO CLEAR EPOXY FLOW OUT PARALLEL TO DATUM B.

DIM	INCH		MILLIMETER		DIM	INCH		MILLIMETER	
	MIN	MAX	MIN	MAX		MIN	MAX	MIN	MAX
AA	.805	.815	20.45	20.70	U		.040		1.02
BB	.382	.388	9.70	9.86	Z		.030		0.76
CC	.125	.170	3.18	4.32	AB	.145	.155	3.68	- 3.94
E	.035	.045	0.89	1.14					
F	.003	.006	0.08	0.15	aaa		.005		0.127
H	.057	.067	1.45	1.70	bbb		.010		0.254
J	.175 BSC		4.44 BSC		ccc		.015		0.381
K	.170	.210	4.32	5.33					
M	.774	.786	19.61	20.02					
N	.772	.788	19.61	20.02					
R	.365	.375	9.27	9.53					
S	.365	.375	9.27	9.52					
© NXP SEMICONDUCTORS N. V. ALL RIGHTS RESERVED			MECHANICAL OUTLINE			PRINT VERSION NOT TO SCALE			
TITLE: NI-780S-4L					DOCUMENT NO: 98ASA10718D REV: C				
					STANDARD: NON-JEDEC				
					SOT1826-1		01 AUG 2016		

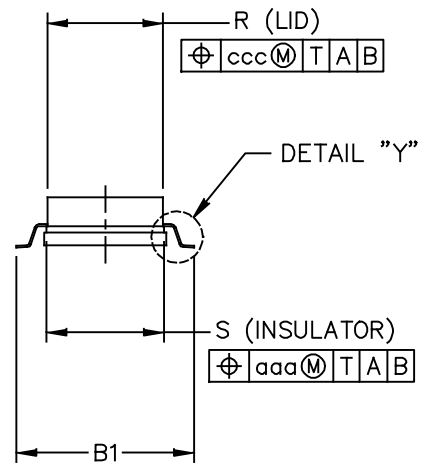
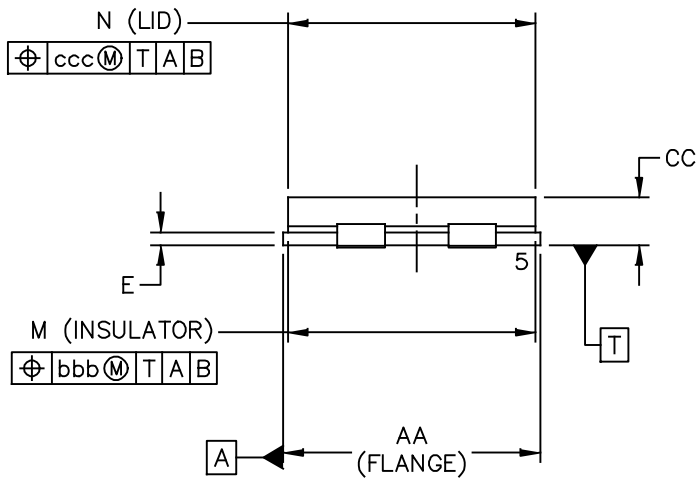
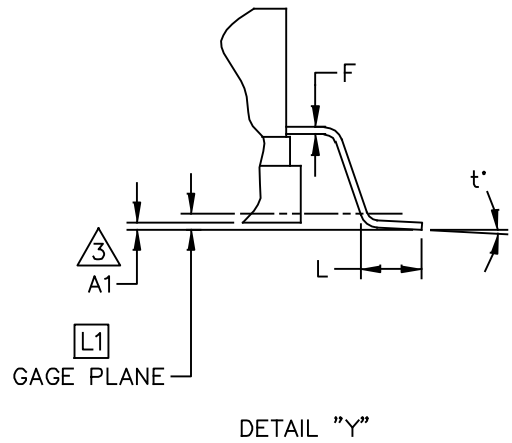
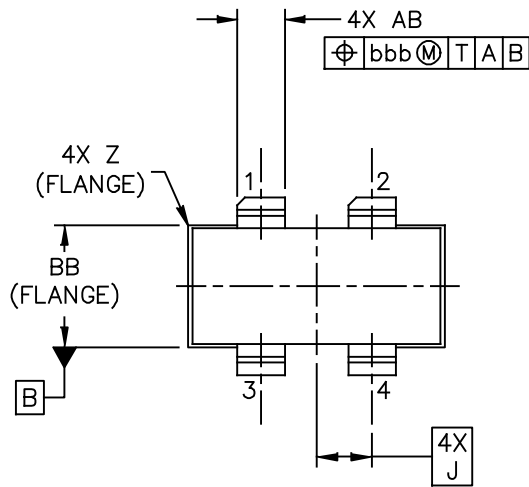

© NXP SEMICONDUCTORS N.V. ALL RIGHTS RESERVED	MECHANICAL OUTLINE	PRINT VERSION NOT TO SCALE	
TITLE: NI-780GS-4L		DOCUMENT NO: 98ASA00238D	REV: C
		STANDARD: NON-JEDEC	
		SOT1805-1	23 FEB 2016

NOTES:

1. DIMENSIONING AND TOLERANCING PER ANSI Y14.5M-1994.

2. CONTROLLING DIMENSION: INCH.

3. DIMENSION A1 IS MEASURED WITH REFERENCE TO DATUM T. THE POSITIVE VALUE IMPLIES THAT THE PACKAGE BOTTOM IS HIGHER THAN THE LEAD BOTTOM.

DIM	INCH		MILLIMETER		DIM	INCH		MILLIMETER	
	MIN	MAX	MIN	MAX		MIN	MAX	MIN	MAX
AA	.805	.815	20.45	20.70	Z	R.000	R.040	R0.00	R1.02
A1	.002	.008	0.05	0.20	AB	.145	.155	3.68	3.94
BB	.380	.390	9.65	9.91	t°	0°	8°	0°	8°
B1	.546	.562	13.87	14.27	aaa	.005		0.13	
CC	.125	.170	3.18	4.32	bbb	.010		0.25	
E	.035	.045	0.89	1.14	ccc	.015		0.38	
F	.003	.006	0.08	0.15					
L	.038	.046	0.97	1.17					
L1	.010 BSC		0.25 BSC						
J	.175 BSC		4.44 BSC						
M	.774	.786	19.66	19.96					
N	.772	.788	19.61	20.02					
R	.365	.375	9.27	9.53					
S	.365	.375	9.27	9.53					
© NXP SEMICONDUCTORS N. V. ALL RIGHTS RESERVED			MECHANICAL OUTLINE			PRINT VERSION NOT TO SCALE			
TITLE: NI-780GS-4L					DOCUMENT NO: 98ASA00238D REV: C				
					STANDARD: NON-JEDEC				
					SOT1805-1			23 FEB 2016	

PRODUCT DOCUMENTATION, SOFTWARE AND TOOLS

Refer to the following resources to aid your design process.

Application Notes

- AN1908: Solder Reflow Attach Method for High Power RF Devices in Air Cavity Packages
- AN1955: Thermal Measurement Methodology of RF Power Amplifiers

Engineering Bulletins

- EB212: Using Data Sheet Impedances for RF LDMOS Devices

Software

- Electromigration MTTF Calculator
- RF High Power Model
- .s2p File

Development Tools

- Printed Circuit Boards

To Download Resources Specific to a Given Part Number:

1. Go to <http://www.nxp.com/RF>
2. Search by part number
3. Click part number link
4. Choose the desired resource from the drop down menu

REVISION HISTORY

The following table summarizes revisions to this document.

Revision	Date	Description
0	Sept. 2018	<ul style="list-style-type: none">• Initial release of data sheet

How to Reach Us:

Home Page:
nxp.com

Web Support:
nxp.com/support

Information in this document is provided solely to enable system and software implementers to use NXP products. There are no express or implied copyright licenses granted hereunder to design or fabricate any integrated circuits based on the information in this document. NXP reserves the right to make changes without further notice to any products herein.

NXP makes no warranty, representation, or guarantee regarding the suitability of its products for any particular purpose, nor does NXP assume any liability arising out of the application or use of any product or circuit, and specifically disclaims any and all liability, including without limitation consequential or incidental damages. "Typical" parameters that may be provided in NXP data sheets and/or specifications can and do vary in different applications, and actual performance may vary over time. All operating parameters, including "typicals," must be validated for each customer application by customer's technical experts. NXP does not convey any license under its patent rights nor the rights of others. NXP sells products pursuant to standard terms and conditions of sale, which can be found at the following address: nxp.com/SalesTermsandConditions.

NXP and the NXP logo are trademarks of NXP B.V. All other product or service names are the property of their respective owners.

© 2018 NXP B.V.

