



# American Opto Plus LED Corp.

## CTD591PG-W/W

15.0 x 15.0 x 11.0 mm Touch LED Pure Green Display

### PACKAGE DIMENSION

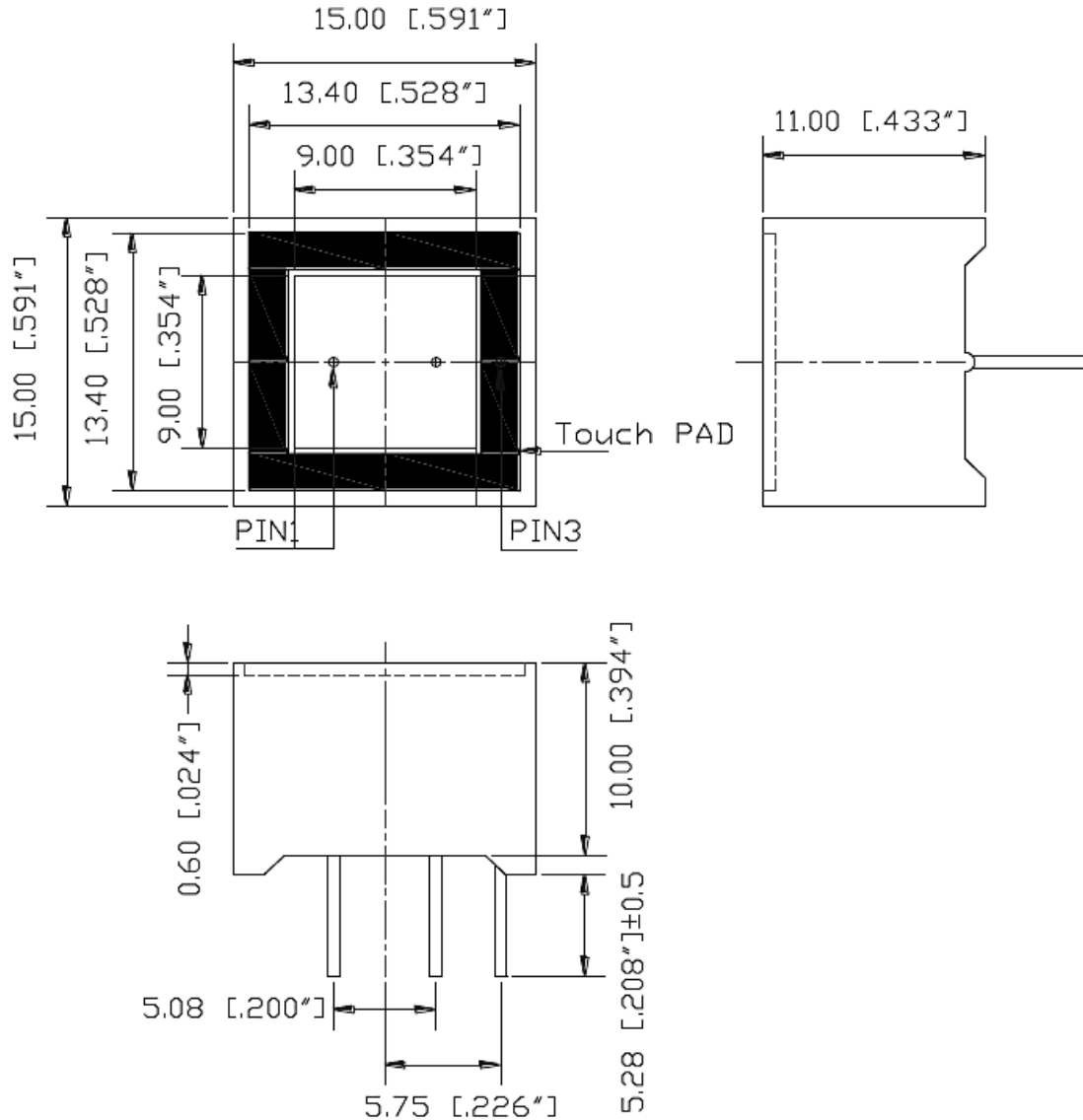

#### Notes:

1. All pins are  $\Phi 0.60[0.24]$ , dimensions in millimeter.
2. Tolerances are  $\pm 0.25[.01]$  unless otherwise noted.

Chip Material	Color	
	Emitter	Face/Segment
InGaN	Pure Green	White/ White



# American Opto Plus LED Corp. CTD591PG-W/W

15.0 x 15.0 x 11.0 mm Touch LED Pure Green Display

## PIN POSITION & INTERNAL CIRCUIT DIAGRAM

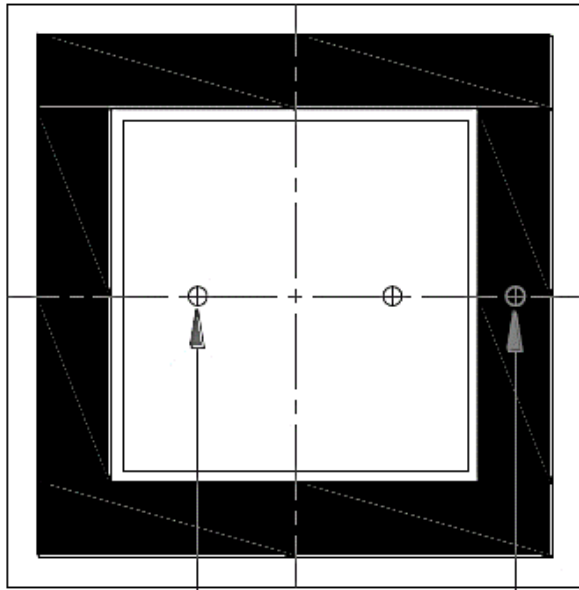

PIN1

PIN3

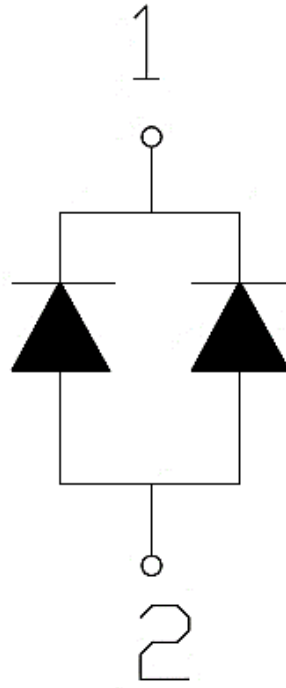

Touch PAD





# American Opto Plus LED Corp.

## CTD591PG-W/W

15.0 x 15.0 x 11.0 mm Touch LED Pure Green Display

### ABSOLUTE MAXIMUM RATINGS

(Ta=25°C)

Parameter	Symbol	Value	Unit
Power Dissipation Per Dice	$P_D$	114	mW
Derating Liner from 25°C Per Dice	--	0.4	mA/°C
Continuous Forward Current Per Dice	$I_F$	30	mA
Peak Current Per Dice (duty cycle 1/10, 1KHz)	$I_{FP}$	100	mA
Reverse Voltage Per Dice	$V_R$	5	V
Operating Temperature Range	$T_{OPR}$	-35~+85	°C
Storage Temperature Range	$T_{STG}$	-35~+85	°C

### OPTICAL-ELECTRICAL CHARACTERISTICS

(Ta=25°C)

Parameter	Symbol	Test Condition	Value			Unit
			Min	Typ	Max	
Forward Voltage	$V_F$	$I_F=20mA$	--	3.2	3.8	V
Luminous Intensity	$I_v$		180.6	380	--	mcd
Dominant Wavelength	$\lambda_D$		--	525	--	nm
Spectrum Radiation Bandwidth	$\Delta\lambda$		--	30	--	nm
Luminous Intensity Matching Ratio	$I_{v-m}$	$I_F=10mA$	--	--	2:1	--
Reverse Current	$I_R$	$V_R=5V$	--	--	50	$\mu A$

Forward voltage tolerance:  $\pm 0.1V$

Luminous intensity tolerance:  $\pm 20\%$



# American Opto Plus LED Corp.

## CTD591PG-W/W

15.0 x 15.0 x 11.0 mm Touch LED Pure Green Display

### LUMINOUS INTENSITY BIN GRADE

( $I_f=20\text{mA}$ )

R	S	T
180.623	288.997	462.397
288.996	462.396	739.835

### COLOR BIN GRADE

( $I_f=20\text{mA}$ )

0	1	2	3	4
522.0	524.0	526.0	528.0	530.0
∩	∩	∩	∩	∩
523.9	525.9	527.9	529.9	532.0



# American Opto Plus LED Corp. CTD591PG-W/W

15.0 x 15.0 x 11.0 mm Touch LED Pure Green Display

## OPTICAL CHARACTERISTIC CURVES

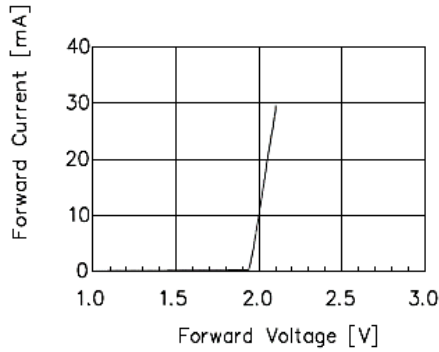

Fig 1. Forward Current vs. Forward Voltage(One chip)

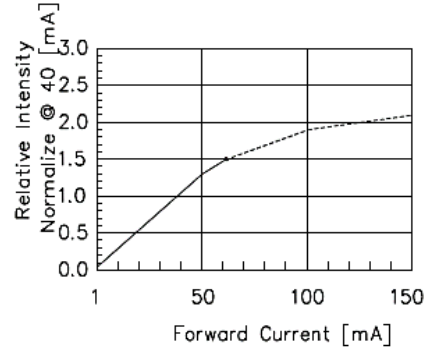

Fig 2. Relative Intensity vs. Forward Current

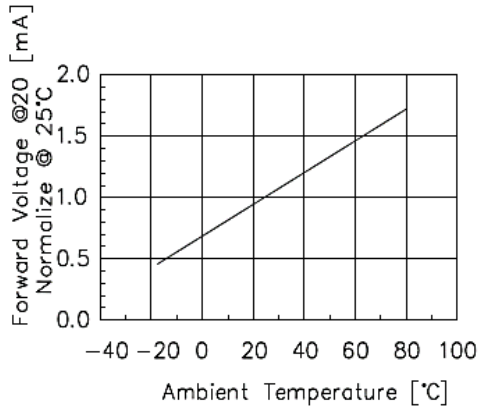

Fig 3. Forward Voltage vs. Temperature(One chip)

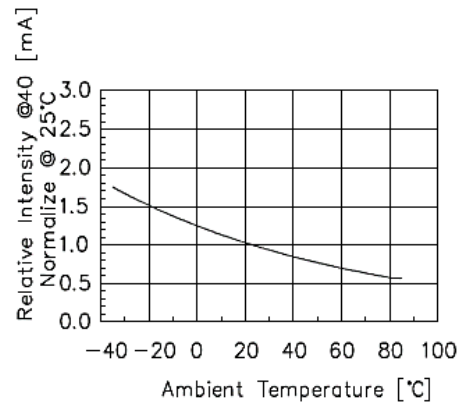

Fig 4. Relative Intensity vs. Temperature

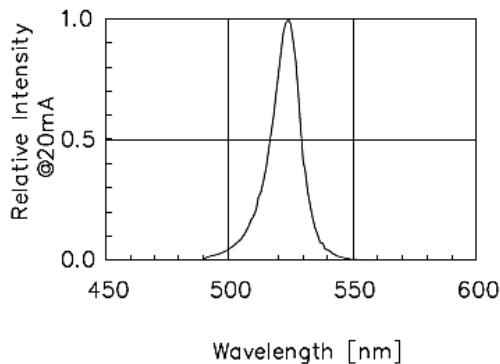

Fig 5. Relative Intensity vs. Wavelength(One chip)

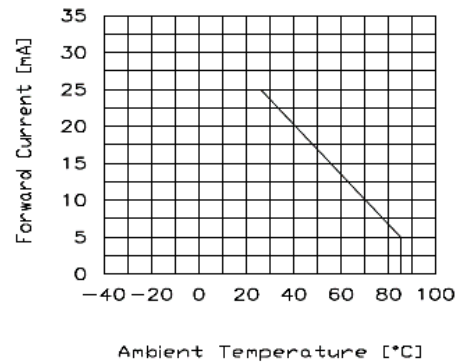

Fig 6. Maximum allowable DC current per segment vs. A function of ambient temperature(One chip)



# American Opto Plus LED Corp.

## CTD591PG-W/W

15.0 x 15.0 x 11.0 mm Touch LED Pure Green Display

### SOLDERING CONDITIONS

#### 1. Wave Soldering Profile

Distance: 1.6mm min (From Seating Plane)

Item	Condition		Note
Preheat	Temperature T1	80 – 120 °C	PWB Temperature (Soldering Side Surface)
	Time t1	60 – 180sec	
Solder Dip	Temperature T2	230 – 260°C	Bath Temperature
	Time t2	2 – 4 sec	Solder Tank Passage Time

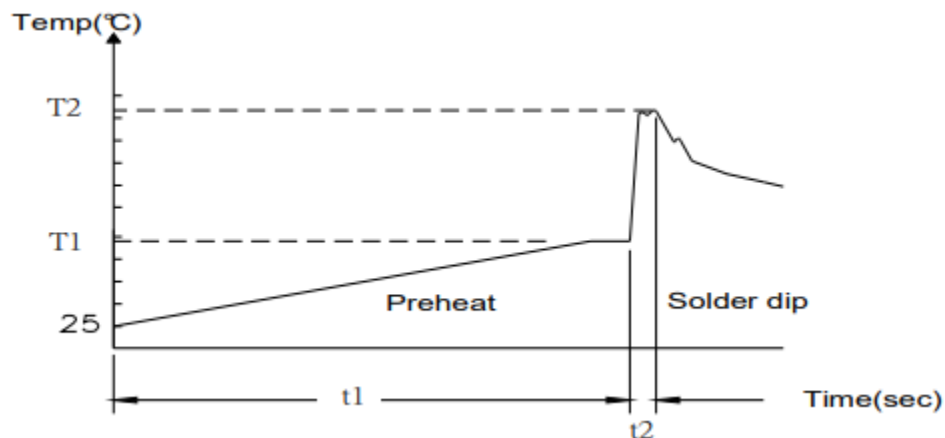

#### 2. Hand Soldering (Iron Condition)

Soldering Iron: 30W Max

Temperature 350°C Max

Soldering Time: 3 Seconds Max (One Time)

Distance: 1.6mm min (From Seating Plane)



# American Opto Plus LED Corp.

## CTD591PG-W/W

15.0 x 15.0 x 11.0 mm Touch LED Pure Green Display

### PACKAGE SPECIFICATION

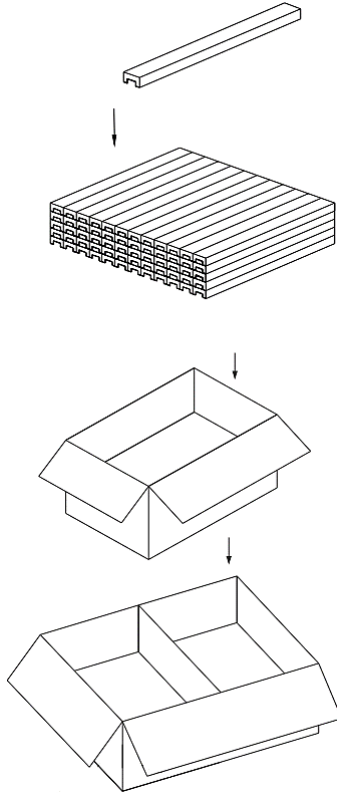

Package	Size	Unit	Amount	Unit	Amount	Unit	Note
TUBE	L300*W190*H20	mm	1	TUBE	10	Pcs	--
Inner Box	L305*W205*H240	mm	187	TUBE	1870	Pcs	17*11=187
Outer Box	L430*W330*H270	mm	2	Inner Box	3740	Pcs	--

### STORAGE METHOD

1. Product cannot be placed on the location of direct sunlight.
2. Product storage environment: Temp. -35°C~85°C, RH 45%~85%.
3. After unpacking the product be use within 1 year.
4. After unpacking, do not take anything up in order to avoid PIN shifting.