



## Quartz Crystal Specification

IQD Part No. + Packaging: LFX TAL028928Reel

Würth Part No. 830028928



### Description

- Industry standard SMD crystal  
Resistance welded, hermetically sealed in an inert atmosphere, glass to metal seals on leads  
Lead wires are mounted onto a plastic former to create a gull wing mount
- Model: HC49/4HSMX
- Model Issue number: 17

### Frequency Parameters

- Frequency: 11.05920MHz
- Frequency Tolerance:  $\pm 30.00$ ppm
- Tolerance Condition: @ 25°C  $\pm 2^\circ\text{C}$
- Frequency Stability:  $\pm 50.00$ ppm
- Operating Temperature Range: -20.00 to 70.00°C
- Overtone Order: Fundamental
- Ageing:  $\pm 5$ ppm typ per year @ 25°C

### Electrical Parameters

- Load Capacitance (CL): 20.00pF
- Shunt Capacitance (C0): 7pF max
- Drive Level: 500 $\mu$ W max
- ESR: 40.00 $\Omega$  max

### Environmental Parameters

- Shock: 981m/s<sup>2</sup>, 6ms, 3 times in each of 3 mutually perpendicular planes
- Vibration: 10Hz-60Hz, 0.75mm amplitude, 60Hz-500Hz, 98.1m/s<sup>2</sup>, 30mins in 3 mutually perpendicular planes
- Storage Temperature Range: -55 to 125°C

### Manufacturing Details

- RoHS Terminations: SnAgCu or Sn
- RoHS Reflow Temp: 260degC 10s

### Compliance

- RoHS Status (2011/65/EU): Compliant
- REACH Status: Compliant
- MSL Rating (JDEC-STD-033): Not Applicable

### Packaging Details

- Pack Style: Reel Tape & reel in accordance with EIA-481-D  
Pack Size: 1,000
- Alternative packing option available

### USEFUL LINKS

#### Toolbox:

[www.we-online.com/toolbox](http://www.we-online.com/toolbox)

#### Product Catalog:

[www.we-online.com/products](http://www.we-online.com/products)



### Outline (mm)

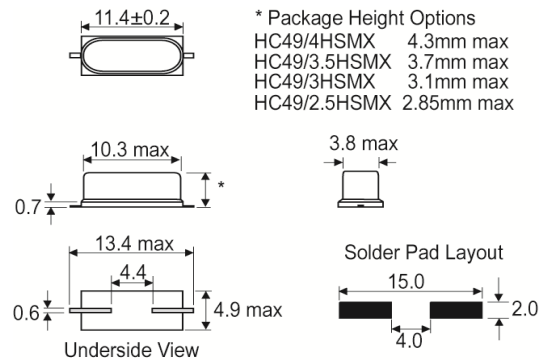

### Typical Frequency vs Temperature Curves

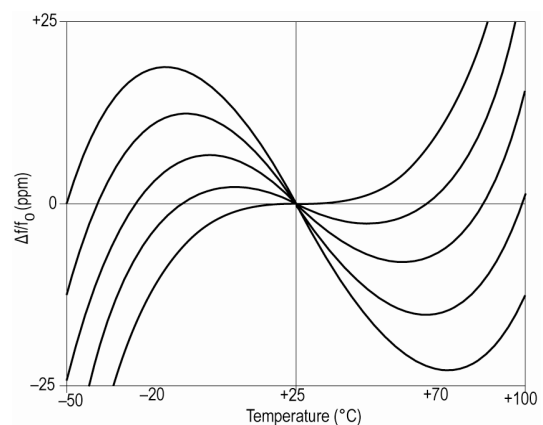

### CONTACT INFORMATION:

Würth Elektronik eiSos GmbH & Co. KG  
Max-Eyth-Str. 1, 74638 Waldenburg, Germany  
Tel: +49(0) 7942 945-0

Email: [eiSos@we-online.de](mailto:eiSos@we-online.de)  
Web: [www.we-online.com](http://www.we-online.com)