

**Data sheet | Item number: 832-1102/037-000**

1-conductor female connector; lever; Push-in CAGE CLAMP®; 16 mm²; Pin spacing 10.16 mm; 2-pole; 100% protected against mismatching; Lateral locking levers; Silver-plated contacts; 16,00 mm²; light gray

[www.wago.com/832-1102/037-000](http://www.wago.com/832-1102/037-000)

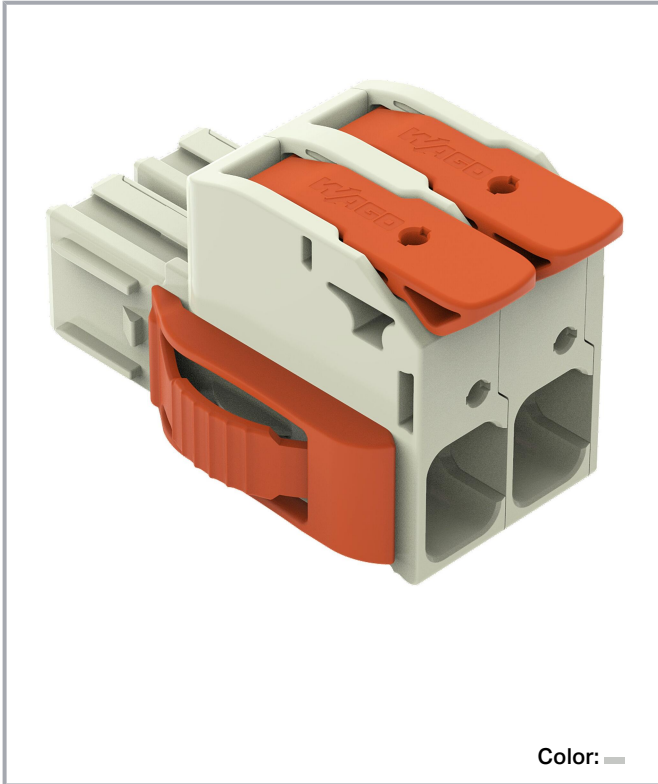

Color: —



Subject to changes. Please also observe the further product documentation!

WAGO GmbH & Co. KG  
Hansastr. 27  
32423 Minden  
Phone: +49571 887-0 | Fax: +49571 887-169  
Email: [info.de@wago.com](mailto:info.de@wago.com) | Web: [www.wago.com](http://www.wago.com)

Do you have any questions about our products?  
We are always happy to take your call at +49 (571) 887-44222.



**Derating Curve**

1-conductor female connector (832-1102) with  
THT male header (832-3622)

Pin spacing: 10.16 mm / Conductor cross-section: 25 mm<sup>2</sup> "f-st"  
Based on: EN 60512-5-2 / Reduction factor: 0.8

Current in A

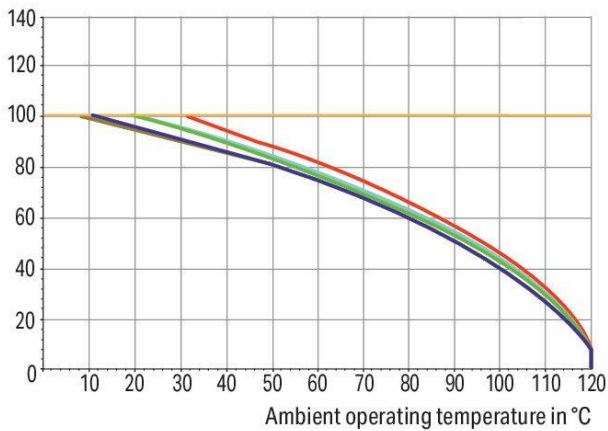

2-, 3-, 4-, 5-, 6- pole      ——— Conductor rated current

**Derating Curve**

1-conductor female connector (832-1102) with  
THT male header (832-3622)

Pin spacing: 10.16 mm / Conductor cross-section: 16 mm<sup>2</sup> "f-st"  
Based on: EN 60512-5-2 / Reduction factor: 0.8

Current in A

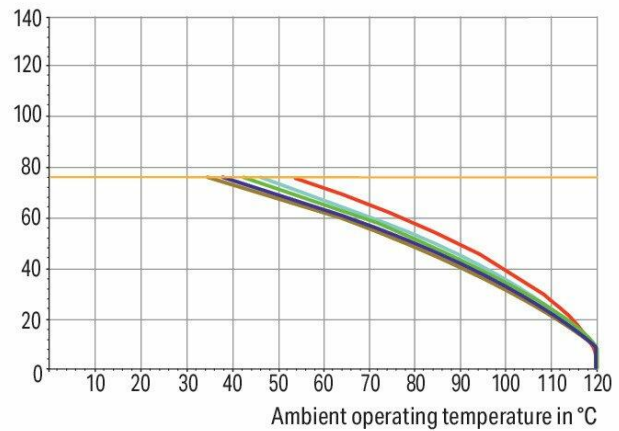

2-, 3-, 4-, 5-, 6- pole      ——— Conductor rated current

Subject to changes. Please also observe the further product documentation!

WAGO GmbH & Co. KG  
Hansastr. 27  
32423 Minden  
Phone: +49571 887-0 | Fax: +49571 887-169  
Email: [info.de@wago.com](mailto:info.de@wago.com) | Web: [www.wago.com](http://www.wago.com)

Do you have any questions about our products?  
We are always happy to take your call at +49 (571) 887-44222.

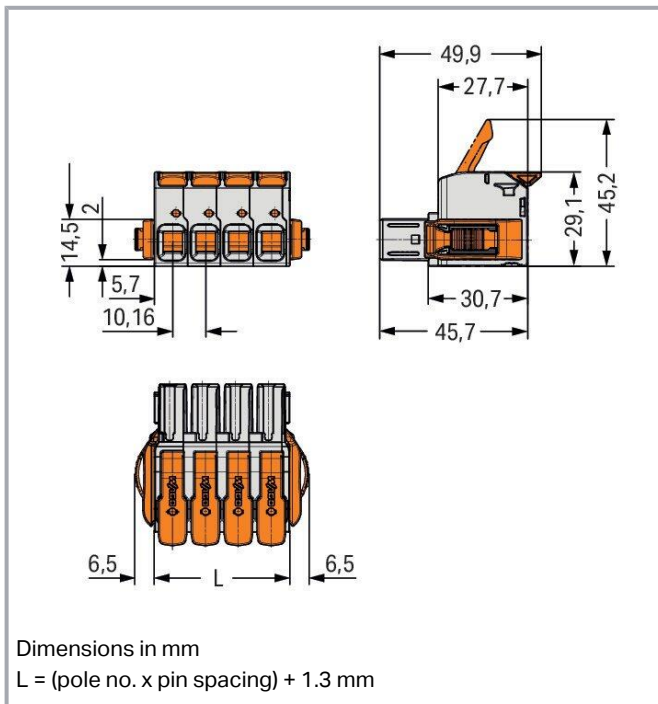

## Item description

- Intuitive and tool-free lever actuation
- Universal connection for all conductor types
- Push-in termination of solid or ferruled conductors
- Test slot 0° and 90° to conductor entry
- 100% protected against mismatching
- Coding option available

## Data

### Notes

#### Safety information

The *MCS – MULTI CONNECTION SYSTEM* includes connectors without breaking capacity in accordance with DIN EN 61984. When used as intended, these connectors must not be connected /disconnected when live or under load. When used as intended, these connectors must not be connected/disconnected when live or under load. The circuit design should ensure header pins, which can be touched, are not live when unmated.

#### Variants:

Other pole numbers

Other versions (or variants) can be requested from WAGO Sales or configured at <https://configurator.wago.com/>.

Subject to changes. Please also observe the further product documentation!

WAGO GmbH & Co. KG

Hansastr. 27

32423 Minden

Phone: +49571 887-0 | Fax: +49571 887-169

Email: [info.de@wago.com](mailto:info.de@wago.com) | Web: [www.wago.com](http://www.wago.com)

Do you have any questions about our products?

We are always happy to take your call at +49 (571) 887-44222.

## Electrical data

### Ratings per IEC/EN

Ratings per	IEC/EN 60664-1
Nominal voltage (III/3)	1000 V
Rated impulse voltage (III/3)	8 kV
Rated voltage (III/2)	1000 V
Rated impulse voltage (III/2)	8 kV
Nominal voltage (II/2)	1000 V
Rated surge voltage (II/2)	8 kV
Rated current	76 A
Legend (ratings)	(III / 2) ≙ Overvoltage category III / Pollution degree 2

### Ratings per UL 1059

Approvals per	UL 1059
Rated voltage UL (Use Group B)	600 V
Rated current UL (Use Group B)	66 A
Rated voltage UL (Use Group C)	600 V
Rated current UL (Use Group C)	66 A

### Ratings per UL 1977

Rated voltage (UL 1977)	600 V
Rated current UL 1977	85 A

### Ratings per CSA

Approvals per	CSA
Rated voltage CSA (Use Group B)	600 V
Rated current CSA (Use Group B)	66 A
Rated voltage CSA (Use Group C)	600 V
Rated current CSA (Use Group C)	66 A

## Connection data

Connection points	2
Total number of potentials	2
Number of connection types	1

Subject to changes. Please also observe the further product documentation!



Number of levels	1
------------------	---

### Connection 1

Connection technology	Push-in CAGE CLAMP®
Actuation type	Lever
Solid conductor	0.75 ... 16 mm <sup>2</sup> / 18 ... 4 AWG
Fine-stranded conductor	0.75 ... 25 mm <sup>2</sup> / 18 ... 4 AWG
Fine-stranded conductor; with insulated ferrule	0.75 ... 16 mm <sup>2</sup>
Fine-stranded conductor; with uninsulated ferrule	0.75 ... 16 mm <sup>2</sup>
Strip length	18 ... 20 mm / 0.71 ... 0.79 inches
Pole number	2
Conductor entry direction to mating direction	0°

### Physical data

Pin spacing	10.16 mm / 0.4 inches
Width	33.62 mm / 1.324 inches
Height	29.1 mm / 1.146 inches
Depth	49.8 mm / 1.961 inches

### Mechanical Data

Variable coding	Yes
Anti-rotation protection	Yes

### Plug-in connection

Contact type (pluggable connector)	Female connector/socket
Connector (connection type)	for conductor
Mismating protection	Yes
Plugging without loss of pin spacing	No
Locking of plug-in connection	lateral locking lever

### Material Data

Note (material data)	Information on material specifications can be found here
Color	light gray
Material group	I

Subject to changes. Please also observe the further product documentation!



Insulation material	Polybutylene terephthalate (PBT)
Flammability class per UL94	V0
Clamping spring material	Chrome-nickel spring steel (CrNi)
Material of the additional spring for socket contact	Chrome-nickel spring steel (CrNi)
Contact material	Electrolytic copper (E <sub>Cu</sub> )
Contact plating	Silver
Fire load	0.543 MJ
Actuator color	orange
Weight	29.2 g

### Environmental requirements

Limit temperature range	-60 ... +120 °C
Processing temperature	-35 ... +60 °C

### Commercial data

eCl@ss 10.0	27-14-11-06
eCl@ss 9.0	27-14-11-06
ETIM 8.0	EC001284
ETIM 7.0	EC001284
PU (SPU)	20 pcs
Packaging type	box
Country of origin	DE
GTIN	4055143921138
Customs tariff number	85366990990

### Environmental Product Compliance



RoHS Compliance Status	Compliant, No Exemption
------------------------	-------------------------

### Approvals / Certificates





#### General approvals

Logo	Approval	Additional Approval Text	Certificate name
	<b>CB</b> DEKRA Certification B.V.	IEC 61984	NL-53084
	<b>CSA</b> DEKRA Certification B.V.	C22.2	70180346





Subject to changes. Please also observe the further product documentation!

	<b>KEMA/KEUR</b> DEKRA Certification B.V.	EN 61984	71- 104731
	<b>UL</b> Underwriters Laboratories Inc.	C22.2 No. 158	E45172

## Counterpart

	<b>Item no.832-1202</b> 1-conductor male connector; lever; Push-in CAGE CLAMP®; 16 mm²; Pin spacing 10.16 mm; 2-pole; 100% protected against mismatching; Silver-plated contacts; 16,00 mm²; light gray	<a href="http://www.wago.com/832-1202">www.wago.com/832-1202</a>
	<b>Item no.832-3642</b> THT male header; 1.2 x 1.2 mm solder pin; angled; 100% protected against mismatching; Silver-plated contacts; Pin spacing 10.16 mm; 2-pole; light gray	<a href="http://www.wago.com/832-3642">www.wago.com/832-3642</a>
	<b>Item no.832-3622</b> THT male header; 1.2 x 1.2 mm solder pin; angled; 100% protected against mismatching; Silver-plated contacts; Pin spacing 10.16 mm; 2-pole; light gray	<a href="http://www.wago.com/832-3622">www.wago.com/832-3622</a>
	<b>Item no.832-3602</b> THT male header; 1.2 x 1.2 mm solder pin; straight; 100% protected against mismatching; Silver-plated contacts; Pin spacing 10.16 mm; 2-pole; light gray	<a href="http://www.wago.com/832-3602">www.wago.com/832-3602</a>

## Optional accessories

Ferrule		
Ferrule		
	<b>Item no.: 216-210</b> Ferrule; Sleeve for 16 mm² / AWG 6; insulated; electro-tin plated; electrolytic copper; gastight crimped; acc. to DIN 46228, Part 4/09.90; blue	<a href="http://www.wago.com/216-210">www.wago.com/216-210</a>
	<b>Item no.: 216-284</b> Ferrule; Sleeve for 1.5 mm² / AWG 16; insulated; electro-tin plated; electrolytic copper; gastight crimped; acc. to DIN 46228, Part 4/09.90; black	<a href="http://www.wago.com/216-284">www.wago.com/216-284</a>
	<b>Item no.: 216-286</b> Ferrule; Sleeve for 2.5 mm² / AWG 14; insulated; electro-tin plated; electrolytic copper; gastight crimped; acc. to DIN 46228, Part 4/09.90; blue	<a href="http://www.wago.com/216-286">www.wago.com/216-286</a>
	<b>Item no.: 216-287</b> Ferrule; Sleeve for 4 mm² / AWG 12; insulated; electro-tin plated; electrolytic copper; gastight crimped; acc. to DIN 46228, Part 4/09.90; gray	<a href="http://www.wago.com/216-287">www.wago.com/216-287</a>

Subject to changes. Please also observe the further product documentation!



**Item no.: 216-288**

Ferrule; Sleeve for 6 mm<sup>2</sup> / AWG 10; insulated; electro-tin plated; electrolytic copper; gastight crimped; [www.wago.com/216-288](http://www.wago.com/216-288)  
acc. to DIN 46228, Part 4/09.90; yellow



**Item no.: 216-289**

Ferrule; Sleeve for 10 mm<sup>2</sup> / AWG 8; insulated; electro-tin plated; electrolytic copper; gastight crimped; [www.wago.com/216-289](http://www.wago.com/216-289)  
acc. to DIN 46228, Part 4/09.90; red

**Mounting adapter**

Mounting accessories



**Item no.: 832-1038**

Mounting adapter; for DIN-35 rail/panel mounting; 3 parts; Pin spacing 10.16 mm; light gray

[www.wago.com/832-1038](http://www.wago.com/832-1038)

**Coding**

Coding



**Item no.: 832-500**

Coding key carrier; orange

[www.wago.com/832-500](http://www.wago.com/832-500)

**Strain relief**

Strain relief plate



**Item no.: 832-532**

Strain relief plate; for female and male connectors; 20.2 mm wide; 1 part; Pin spacing 10.16 mm; 2-pole; [www.wago.com/832-532](http://www.wago.com/832-532)  
light gray

**Downloads**

**Documentation**

**Additional Information**

Technical Section	2019 Apr 3	pdf	Download
Technical explanations		2.0 MB	

**CAD/CAE-Data**

**CAD data**

2D/3D Models 832-1102/037-000	URL	Download
-------------------------------	-----	----------

**PCB Design**

Symbol and Footprint 832-1102/037-000	URL	Download
---------------------------------------	-----	----------

CAX data for your PCB design, consisting of "schematic symbols and PCB footprints", allow easy integration of the WAGO component into your development environment.

**Supported formats:**

Subject to changes. Please also observe the further product documentation!





- Accel EDA 14 & 15
- Altium 6 to current version
- Cadence Allegro
- DesignSpark
- Eagle Libraries
- KiCad
- Mentor Graphics BoardStation
- Mentor Graphics Design Architect
- Mentor Graphics Design Expedition 99 and 2000
- OrCAD 9.X PCB and Capture
- PADS PowerPCB 3, 3.5, 4.X, and 5.X
- PADS PowerPCB and PowerLogic 3.0
- PCAD 2000, 2001, 2002, 2004, and 2006
- Pulsonix 8.5 or newer
- STL
- 3D STEP
- TARGET 3001!
- View Logic ViewDraw
- Quadcept
- Zuken CadStar 3 and 4
- Zuken CR-5000 and CR-8000

PCB Component Libraries (EDA), PCB CAD Library Ultra Librarian

---

#### CAE data

ZUKEN Portal 832-1102/037-000	<a href="#">URL</a>	<a href="#">Download</a>
-------------------------------	---------------------	--------------------------

---

## Environmental Product Compliance

### Compliance Search

Environmental Product Compliance 832-1102/037-000	<a href="#">URL</a>	<a href="#">Download</a>
---	---------------------	--------------------------

1-conductor female connector; lever; Push-in CAGE CLAMP®; 16 mm<sup>2</sup>; Pin spacing 10.16 mm; 2-pole; 100% protected against mismatching; Lateral locking levers; Silver-plated contacts; 16,00 mm<sup>2</sup>; light gray

---

## Installation Notes

Subject to changes. Please also observe the further product documentation!

---

WAGO GmbH & Co. KG  
Hansastr. 27  
32423 Minden  
Phone: +49571 887-0 | Fax: +49571 887-169  
Email: [info.de@wago.com](mailto:info.de@wago.com) | Web: [www.wago.com](http://www.wago.com)

Do you have any questions about our products?  
We are always happy to take your call at +49 (571) 887-44222.

### Conductor termination

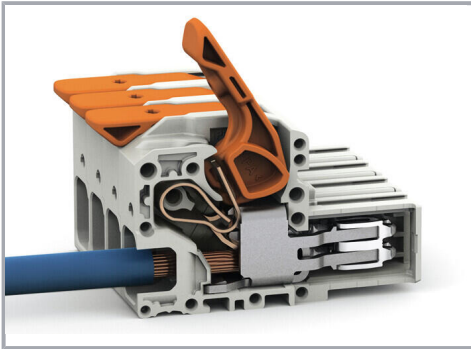

Insert fine-stranded conductors – and remove all conductors – via operating tool.

### Conductor termination



Fine-stranded wires, connected

### Product family

*MCS* MAXI 16

[Show all products from the family](#)

Subject to changes. Please also observe the further product documentation!