

**Contact Information**

**522-P.C. Tail, Regular Point - Tail LG.=.375(9.53)**

**.100" (2.54mm) Contact Spacing x .200" (5.08mm) Row Spacing**

THIS IS A C.A.D. GENERATED DRAWING  
DO NOT MAKE MANUAL REVISIONS TO MASTER.



ISSUE NUMBER

ORIGINAL ①

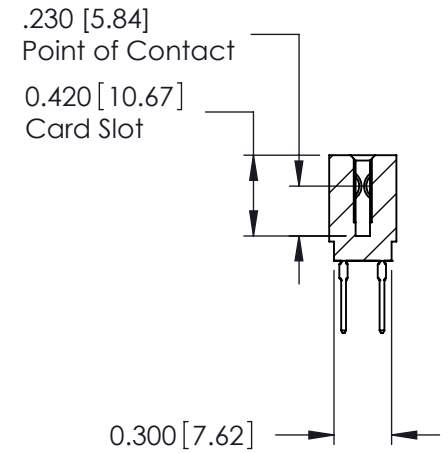
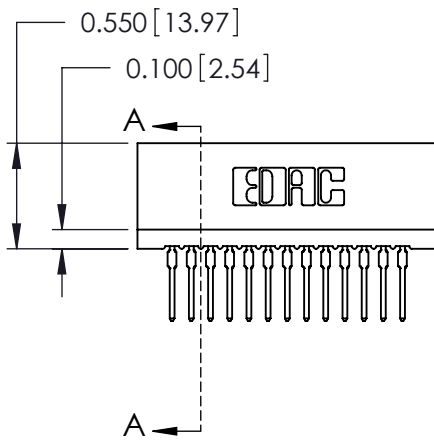
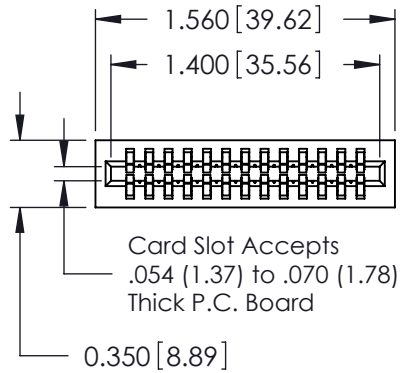

725 Series Ultra-Mate Card Edge Connector - Press Fit

Part Number: 725-026-522-201

ACAD REFERENCE NO. 725-ENG MASTER SECTION A-A

DRAWN: J.LEE DATE: AUG31/09

CHECKED: DATE:

SCALE: SHEET 1 OF 1

DRAWING NUMBER ISSUE

725-ENG MASTER

1



EDAC INC  
TORONTO, ONTARIO  
CANADA

YOUR CONNECTION TO QUALITY & SERVICE

THESE DRAWINGS AND SPECIFICATIONS  
ARE THE PROPERTY OF EDAC INC. AND  
SHALL NOT BE REPRODUCED, OR COPIED  
OR USED AS THE BASIS FOR THE  
MANUFACTURE OR SALE OF APPARATUS  
WITHOUT WRITTEN PERMISSION.