

Basic Characteristics Data

Model	Circuit method	Switching frequency [kHz]	Input current [A]	Rated input fuse	Inrush current protection	PCB/Pattern			Series/Parallel operation availability	
						Material	Single sided	Double sided	Series operation	Parallel operation
SFS10	Single ended forward converter	570 - 670	*1	-	-	glass fabric base,epoxy resin		Multilayer	Yes	Yes
SFS15 SFCS15	Single ended forward converter	570 - 670	*1	-	-	glass fabric base,epoxy resin		Multilayer	Yes	Yes
SFS20	Single ended forward converter	570 - 670	*1	-	-	glass fabric base,epoxy resin		Multilayer	Yes	Yes
SFS30 SFCS30	Single ended forward converter	440 - 530	*1	-	-	glass fabric base,epoxy resin		Multilayer	Yes	Yes

*1 Refer to Specification.

1	Pin Configuration	SFS/SFCS-16
2	Connection for Standard Use	SFS/SFCS-16
3	Wiring Input / Output Pin	SFS/SFCS-16
3.1	Wiring input pin	SFS/SFCS-16
3.2	Wiring output pin	SFS/SFCS-17
4	Function	SFS/SFCS-18
4.1	Overcurrent protection (OCP) and Low voltage protection (LVP)	SFS/SFCS-18
4.2	Overvoltage protection (OVP)	SFS/SFCS-18
4.3	Remote ON / OFF (RC pin)	SFS/SFCS-18
4.4	Alarm (ALM pin)	SFS/SFCS-18
4.5	Start in / out (PO pin)	SFS/SFCS-19
4.6	Sequence	SFS/SFCS-19
4.7	Isolation	SFS/SFCS-19
5	Series and Parallel Operation	SFS/SFCS-19
5.1	Series operation	SFS/SFCS-19
5.2	Parallel operation	SFS/SFCS-20
6	Implementation · Mounting Method	SFS/SFCS-20
6.1	Automatic mounting	SFS/SFCS-20
6.2	Soldering temperature	SFS/SFCS-20
6.3	Cleaning	SFS/SFCS-20
6.4	Mounting method	SFS/SFCS-21
6.5	Storage method	SFS/SFCS-21
6.6	Stress to the product	SFS/SFCS-21
7	Safety Considerations	SFS/SFCS-21
8	Derating	SFS/SFCS-21
8.1	Derating curve (SFS1048, SFS1548)	SFS/SFCS-21
8.2	Derating curve (SFS1524, SFCS15)	SFS/SFCS-22
8.3	Derating curve (SFS2048)	SFS/SFCS-22
8.4	Derating curve (SFS3024, SFCS30)	SFS/SFCS-22
8.5	Derating curve (SFS3048)	SFS/SFCS-23
9	SMD type Package Information	SFS/SFCS-25
9.1	Delivery package information (SFS series SMD type)	SFS/SFCS-25
9.2	Delivery package information (SFCS series SMD type)	SFS/SFCS-25

1 Pin Configuration

●SFS10 / SFS15 / SFS20 / SFCS15

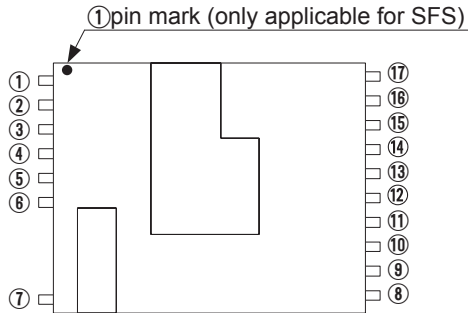

Fig.1.1 Pin configuration (SFS10 / SFS15 / SFS20 / SFCS15)

●SFS30 / SFCS30

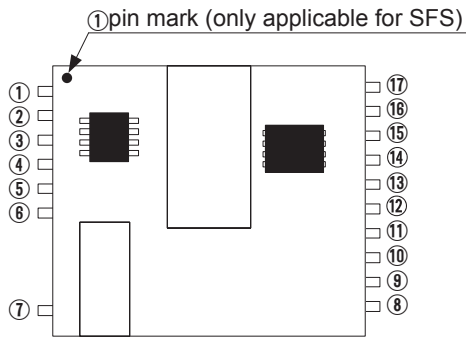

Fig.1.2 Pin configuration (SFS30 / SFCS30)

Table 1.1 Pin configuration and function

No.	Pin Name	Function
①	NC(SMD)	Not connected / Adhesive dispensing
	Stopper(DIP)	Stopper
②	+Vout	+DC output
③	+Vout	+DC output
④	+Vout	+DC output
⑤	-Vout	-DC output
⑥	-Vout	-DC output
⑦	NC(SMD)	Not connected / Adhesive dispensing
	Stopper(DIP)	Stopper
⑧	NC(SMD)	Not connected / Adhesive dispensing
	NC(DIP)	Not connected
⑨	ALM	Alarm
⑩	RC	Remote ON / OFF
⑪	PO	Start in / out
⑫	NC(SMD)	Not connected
	Stopper(DIP)	Stopper
⑬	+Vin	+DC input
⑭	+Vin	+DC input
⑮	-Vin	-DC input
⑯	-Vin	-DC input
⑰	NC(SMD)	Not connected / Adhesive dispensing
	NC(DIP)	Not connected
Case connecting pin		Isolated from internal circuit Only applicable for SFCS type C (DIP)

2 Connection for Standard Use

■ In order to use the power supply, it is necessary to wire as shown in Fig.2.1.

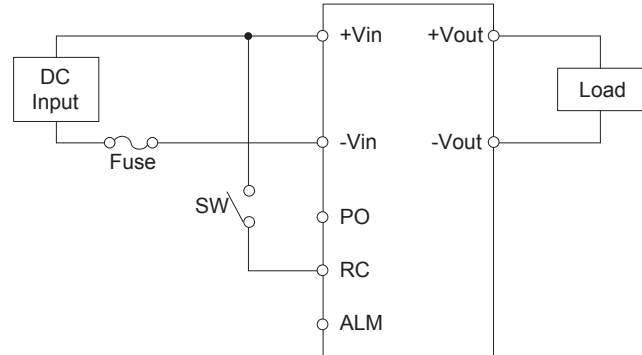

Fig.2.1 Connection for standard use

■ When remote ON / OFF function is not used, please open RC pin or short between RC and -Vin pin.

■ When alarm function is not used, please open ALM pin.

■ In parallel and series operation, connect each PO pin mutually. When PO function is not used, please open PO pin.

■ The SFS / SFCS series handles only the DC input. Avoid applying AC input directly.

!! It will damage the power supply. !!

■ Operate with the convection or forced air cooling.

[Reference : 8 "Derating"]

3 Wiring Input/Output Pin

3.1 Wiring input pin

(1) External fuse

■ The SFS / SFCS series is not internally fused. To ensure safe operation and to receive each Safety Standards approvals, please install an external fuse (fast-blow type).

■ When the input voltage from a front end unit is supplied to multiple units, install a fast-blow type fuse in each unit.

■ Fuse must be connected to the +Vin side if to -Vin side is used as ground, or fuse must be connected to -Vin side if +Vin side is used as a ground.

Table 3.1 Recommended fuse (fast-blow type)

Model	SFS1524 / SFCS1524	SFS3024 / SFCS3024
Rated current	2A	4A
Model	SFS1048/SFS1548/SFCS1548	SFS2048/SFS3048/SFCS3048
Rated current	1A	2A

(2) External capacitor on the input side

■When the distance from the DC line to the unit is greatly extended, it makes the input feedback noise much higher and the input voltage several times higher than the normal level when turned ON. If this happens, the output power also becomes unstable. In order to prevent the unit from failing in this way; please connect C_i to the input pin. In addition, when the filter with "L" is used, please C_i to the input pin.

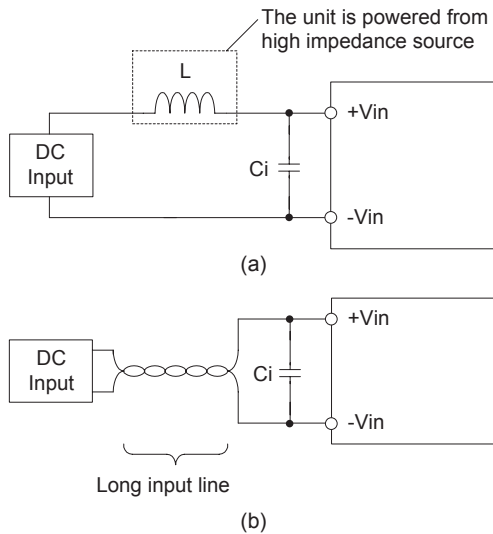

Fig.3.1 Connection method of capacitor at input pin

Table 3.2 Recommended capacitance C_i

Model	SFS1524 / SFCS1524	SFS3024/SFCS3024
C_i	33 μ F	68 μ F
Model	SFS1048/SFS1548/SFS2048/SFCS1548	SFS3048/SFCS3048
C_i	10 μ F	22 μ F

[$T_a = -20$ to $+85^\circ\text{C}$ Electrolytic or Ceramic capacitor
 $T_a = -40$ to $+85^\circ\text{C}$ Ceramic capacitor]

Note:

When input line inductance becomes excessively high due to insertion of choke coil, operation of the unit could become unstable. In this case, increase C_i value more than the value indicated above.

(3) Conducted noise

■Install an external input filter as shown in Fig.3.2 in order to reduce conducted noise.

The result for this solution is shown in Fig.3.3.

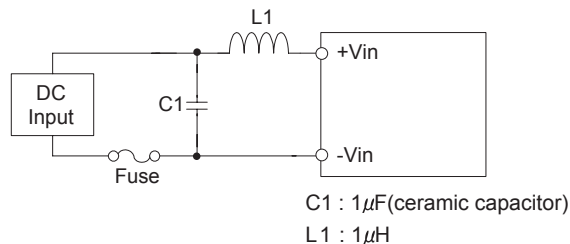

Fig.3.2 Recommended external input filter

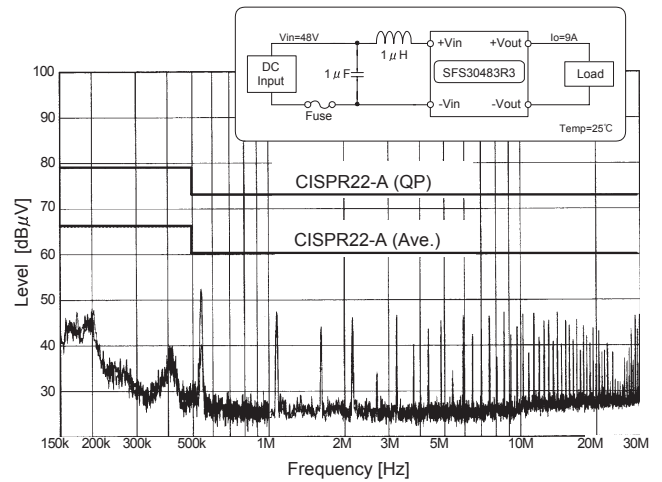

Fig.3.3 Example of conducted noise (SFS30483R3)

(4) Reverse input voltage protection

■Avoid the reverse polarity input voltage. It will damage the unit. It is possible to protect the unit from the reverse input voltage by installing an external diode as shown in Fig.3.4.

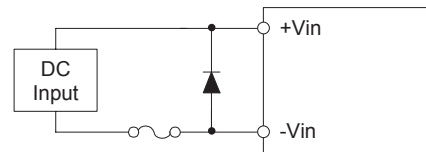
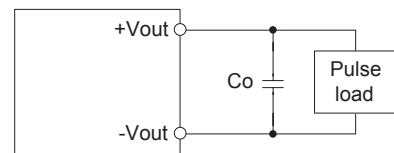

Fig.3.4 Reverse input voltage protection

3.2 Wiring output pin

■When the SFS / SFCS series supplies the pulse current for the pulse load, please install capacitor C_o between +Vout and -Vout pins.



Recommended capacitance (C_o)
 1.2 - 5Vout : 22 - 4700 μ F
 10 - 15Vout : 22 - 2200 μ F

Fig.3.5 Connection for pulse load

■Output ripple and start-up waveform may be influenced by ESR · ESL of capacitor and the wiring impedance.

■Ripple and ripple noise are measured, as shown in the Fig.3.6, by connecting Co and JEITA attachment.

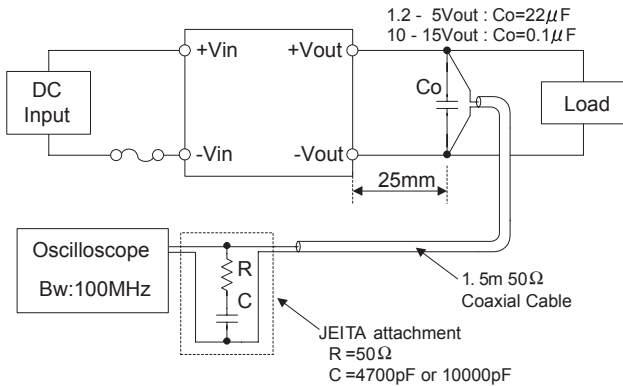

Fig.3.6 Measuring method of ripple and ripple noise

4 Function

4.1 Overcurrent protection (OCP) and Low voltage protection (LVP)

- OCP and LVP circuits is built-in. LVP will trigger after 200ms typ delay when OCP activates and output voltage drops down 90% max (SFS20 : 95% max) of the rated output voltage.
- When LVP is activated, ALM signal will becomes low impedance.
- Recovery from the protection is accomplished by applying 5VDC or less input for at least 1 second, or toggling remote ON / OFF signal for at least 1 second.

4.2 Overvoltage protection (OVP)

- The overvoltage protection circuit is built-in and comes into effect at 120% to 140% (SFS20 : 115% to 145%) of the rated output voltage. When the load factor is less than 50%, output voltage may be increased more than maximum voltage by the failure mode.
- Normal or abnormal operation of the unit can be monitored by using the ALM pin. When OVP is activated, ALM signal will become low level.
- The DC input should be shut down if overvoltage protection is in operation.
- Please note that devices inside the power supply might fail when voltage more than rated output voltage is applied to output pin of the power supply. This could happen when the customer tests the overvoltage performance of the unit.

4.3 Remote ON / OFF (RC pin)

- Remote ON / OFF circuits is built-in on input side.
- When remote ON / OFF function is not use, please open-circuit between RC and +Vin or short-circuit between RC and -Vin.
- Recovery from the protection is accomplished by applying 5VDC or less input for at least 1 second, or toggling remote ON / OFF signal for at least 1 second.

(1) RC connection example 1

■Remote ON / OFF connection and specification refer to below.

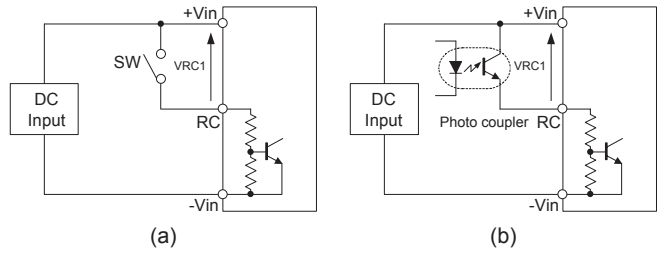
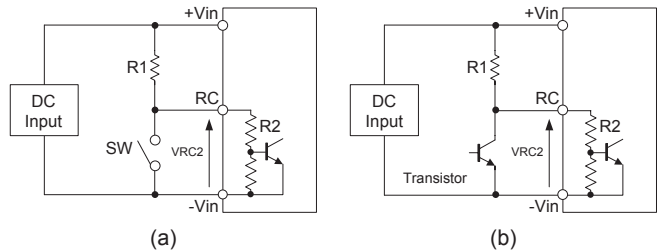

Fig.4.1 RC connection example 1

Table 4.1 Specification of example 1 (connection method Fig.4.1 (a), (b))

Between RC and +Vin (VRC1)	Output voltage
Open	ON
$0V \leq VRC1 \leq 1.2V$ or Short	OFF

(2) RC connection example 2



Recommended value of R1

Model	SFS□24	SFS□48
	SFCS□24	SFCS□48
R1	22kΩ	220kΩ

Value of R2

Model	SFS□24	SFS□48
	SFCS□24	SFCS□48
R2	200kΩ	360kΩ

Fig.4.2 RC connection example 2

Table 4.2 Specification of example 2 (connection method Fig.4.2 (a), (b))

Between RC and -Vin (VRC2)	Output voltage
10V or more (SFS□24 / SFCS□24) 20V or more (SFS□48 / SFCS□48) or Open	OFF
$0V \leq VRC2 \leq 1.2V$ or Short	ON

4.4 Alarm (ALM pin)

- Normal or abnormal operation of the unit can be monitored by using the ALM pin.
- When OVP or LVP are activated, ALM pin becomes same level as -Vin pin.
- The sink current of ALM pin is 10mA max.

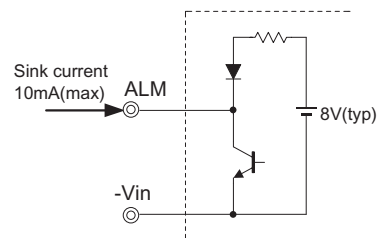

Fig.4.3 ALM circuit

- By connecting ALM pin in parallel and series operation, when one unit has shut down by overvoltage protection or low voltage protection, other units will be shut down.
- When alarm function is not use, please open ALM pin.
- Total number of units should be no more than 20 pieces.

4.5 Start in / out (PO pin)

- By connecting PO pin, difference of start-up voltage and stop voltage can be prevented.
- In parallel and series operation, please connect each PO pin mutually.
- Total number of units should be no more than 20 pieces.

4.6 Sequence

- The sequence time chart of Vin, Vout, PO, ALM and RC pins is shown in Fig.4.4.

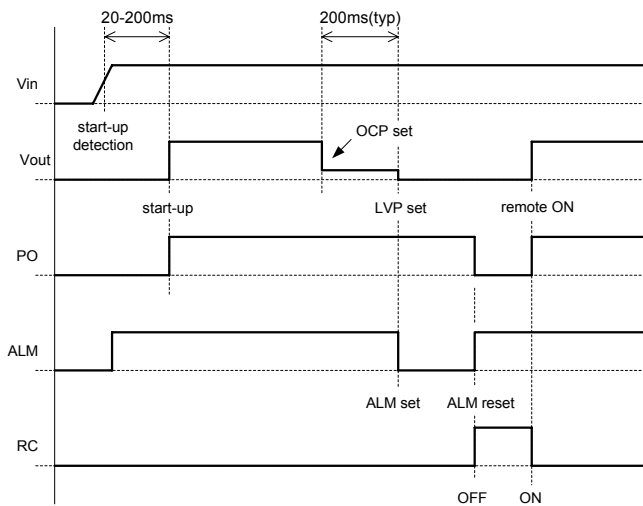

Fig.4.4 Sequence time chart

4.7 Isolation

- For a receiving inspection, such as Hi-Pot test, gradually increase (decrease) the voltage for a start (shut down). Avoid using Hi-Pot tester with the timer because it may generate voltage a few times higher than the applied voltage, at ON / OFF of a timer.

5 Series and Parallel Operation

5.1 Series operation

- In series operation, connect each PO and ALM pin mutually, wiring as Fig.5.1.

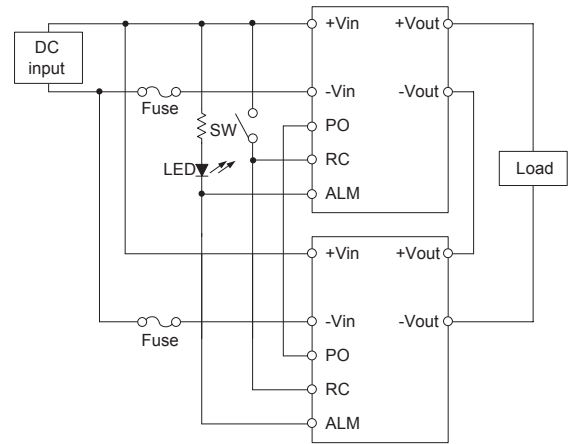

(a) Connection 1

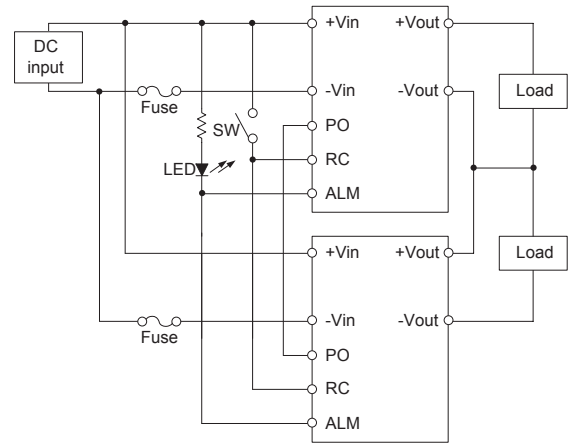

(b) Connection 2

Fig.5.1 Examples of series operation

5.2 Parallel operation

- In parallel operation, connect each PO and ALM pin mutually, wiring as Fig.5.2.
- To improve the load sharing of each unit, please use the same length from each unit to the load.
- Total number of units should be no more than 10 pieces.

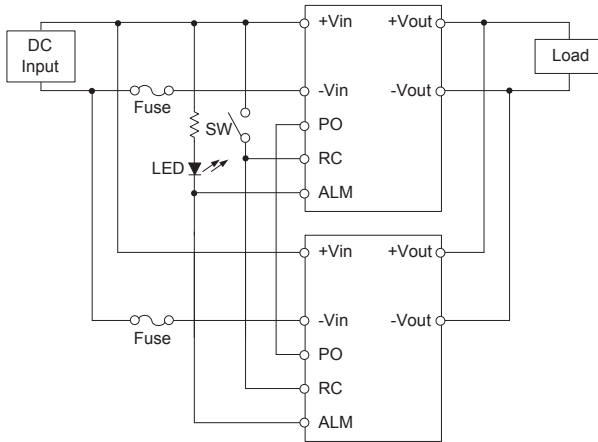

Fig.5.2 Example of parallel operation

6 Implementation · Mounting Method

6.1 Automatic mounting

- SFS / SFCS series is designed to have a large flat area in the center of the top surface to serve as a pick up point for automated vacuum pick and place equipment.
- An excessively low bottom dead point of the suction nozzle imposes great force on the core of SFS series during mounting, causing cracked core. So during mounting, take enough care.

6.2 Soldering temperature

(1) Reflow soldering

- Fig.6.1 and 6.2 show the conditions of reflow soldering. Please verify the temperature of the ALM pin and +Vout pin satisfy to reflow condition.
- Improper reflow condition may degrade the reliability of the internal components.
- While soldering, having vibration or impact on the unit should be avoided, because of solder melting.

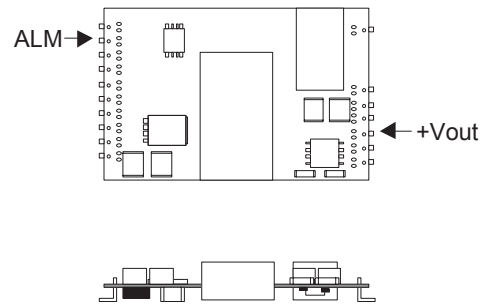
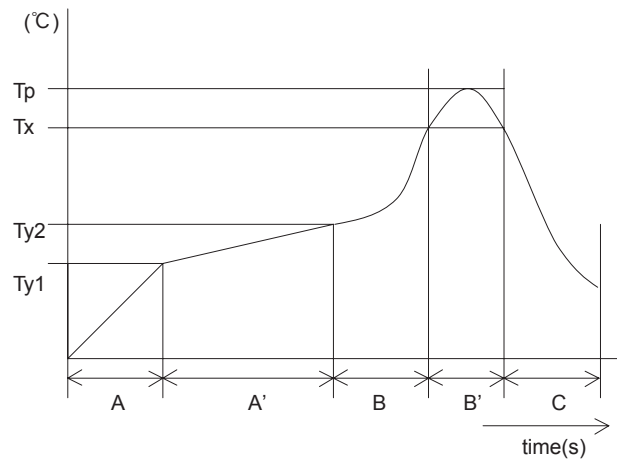

Fig.6.1 Measuring point



A	1.0 - 5.0°C/ s
A'	Ty1 : 160±10°C Ty2 : 180±10°C Ty1 - Ty2 : 120s max
B	1.0 - 5.0°C/ s
B'	Tp : Max245°C 10s max Tx : 220°C or more : 70s max
C	1.0 - 5.0°C/ s

Fig.6.2 Recommended reflow condition of soldering
(Temperature of the pins)

(2) Flow soldering

- 260°C, less than 15 seconds.

(3) Soldering iron

- 340°C to 360°C, less than 5 seconds.

6.3 Cleaning

- When cleaning is necessary, follow the undermentioned condition.
Method: Varnishing, ultrasonic wave and vapor
Cleaning agents: IPA (Solvent type)
Total time: 2 minutes or less
- After cleaning, dry them enough.

6.4 Mounting method

■ Avoid placing pattern layout in hatched area in Fig.6.3 to insulate between pattern and power supply.

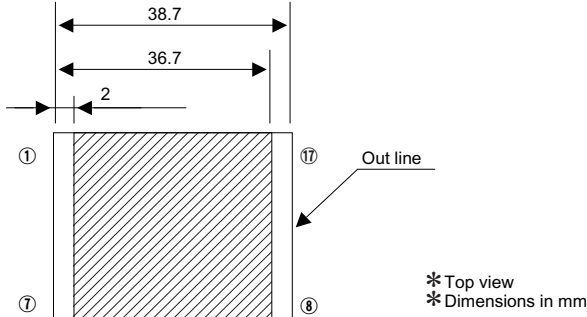

Fig.6.3 Prohibition area of pattern lay out

6.5 Storage method

■ To stock unpacked products in your inventory, it is recommended to be kept under controlled condition, 5-30°C, 60%RH and be used within a year.

■ 24-hours-baking is recommended at 125°C, if unpacked products was kept under uncontrol condition, in which 30°C, 60%RH or higher.

Original tray is not heat-resistant, please move them to heat-resistant tray preparing to bake them.

To check moisture condition in the pack, silica gel packet has some moisture condition indicator particle.

Indicated blue means good. Pink means alarm to bake it.

■ Notification. the tray will be deformed and the power supply might be damaged, if the vacuum pressure is too much to reseal.

6.6 Stress to the product

■ SFS/SFCS series transformer core and choke coil core are attached by glue, and there is a cover over the core, which is attached by a clasp.

There is a possibility that the core will be removed and power supply will be damaged when it took stress by the fall or some kind of stress.

7 Safety Considerations

■ To apply for safety standard approval using this power supply, the following conditions must be met.

- This unit must be used as a component of the end-use equipment.
- The equipment does neither contain any basic nor double / reinforced insulation between input and output.
If the input voltage is greater than 60VDC, this has to be provided by the end-use equipment according to the final build in condition.
- Safety approved fuse must be externally installed on input side.

8 Derating

■ It is necessary to note thermal fatigue life by power cycle.

Please reduce the temperature fluctuation range as much as possible when the up and down of temperature are frequently generated.

8.1 Derating curve (SFS1048, SFS1548)

(1) Single and series operation

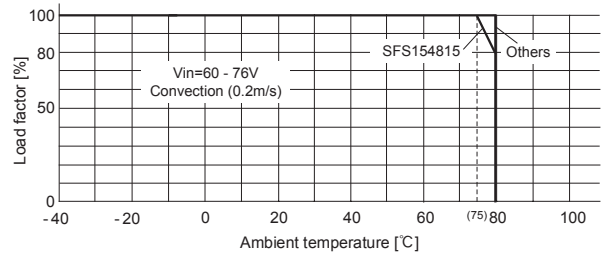
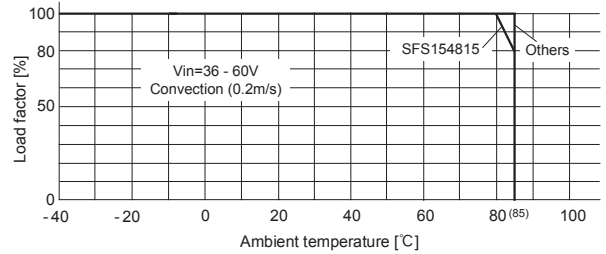

Fig.8.1 Derating curve

(2) Parallel operation

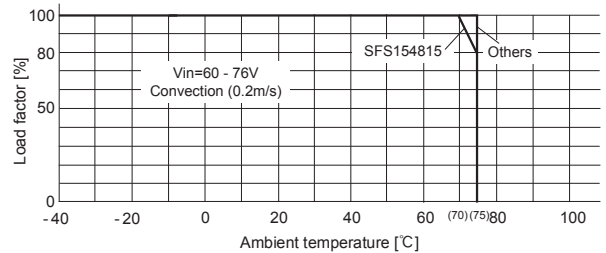
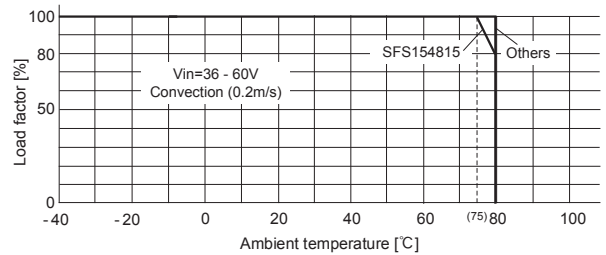

Fig.8.2 Derating curve (Parallel operation)

8.2 Derating curve (SFS1524, SFCS15)

(1) Single and series operation

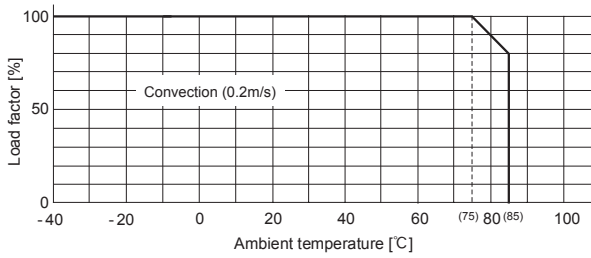

Fig.8.3 Derating curve

(2) Parallel operation

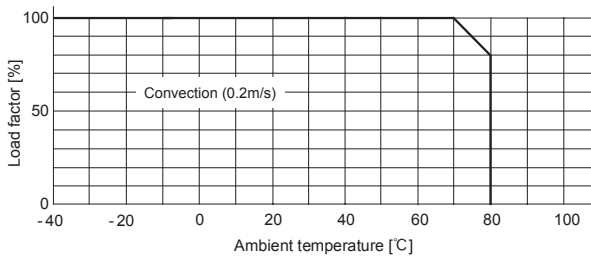

Fig.8.4 Derating curve (Parallel operation)

8.3 Derating curve (SFS2048)

(1) Single, series and parallel operation

① Natural convection cooling (0.2m/s)

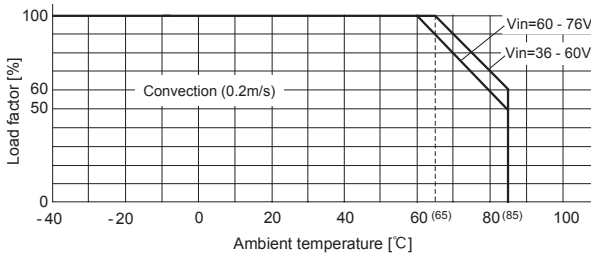

Fig.8.5 Derating curve (Convection)

② Forced air cooling (0.8m/s)

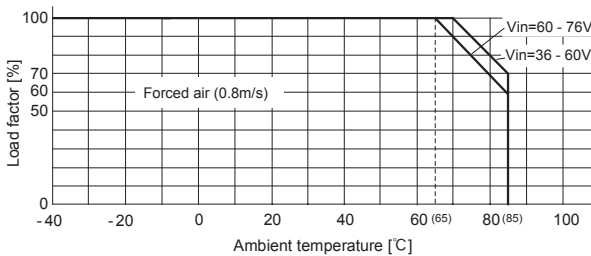

Fig.8.6 Derating curve (Forced air 0.8m/s)

③ Forced air cooling (1.2m/s)

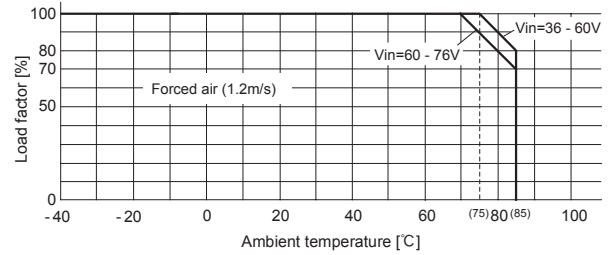

Fig.8.7 Derating curve (Forced air 1.2m/s)

8.4 Derating curve (SFS3024, SFCS30)

(1) Single and series operation

① Natural convection cooling (0.2m/s)

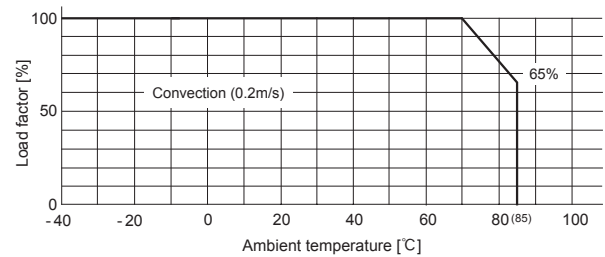

Fig.8.8 Derating curve (Convection)

② Forced air cooling (0.8m/s)

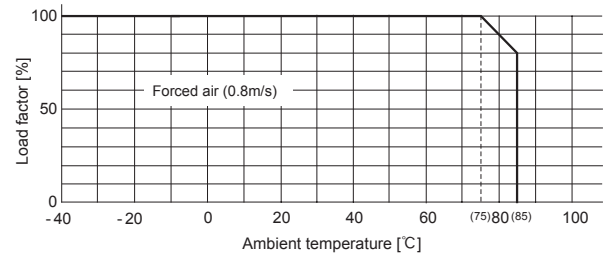

Fig.8.9 Derating curve (Forced air 0.8m/s)

③ Forced air cooling (1.2m/s)

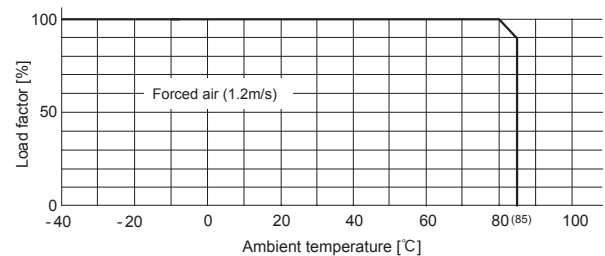

Fig.8.10 Derating curve (Forced air 1.2m/s)

(2) Parallel operation

① Natural convection cooling (0.2m/s)

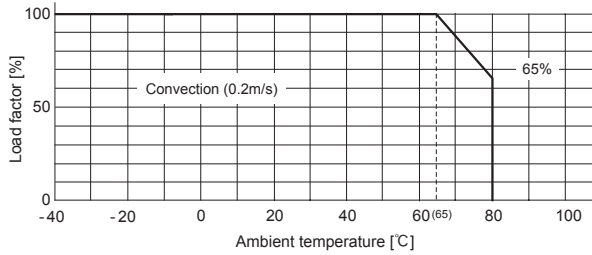

Fig.8.11 Derating curve (Convection)

② Forced air cooling (0.8m/s)

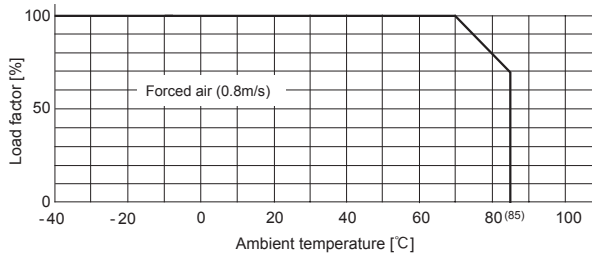

Fig.8.12 Derating curve (Forced air 0.8m/s)

③ Forced air cooling (1.2m/s)

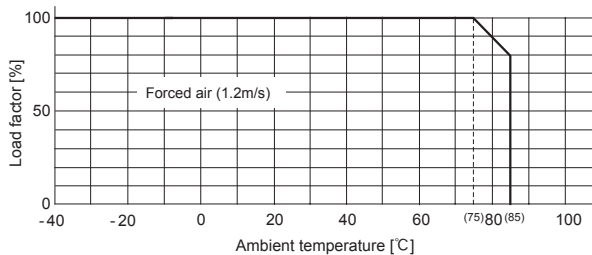

Fig.8.13 Derating curve (Forced air 1.2m/s)

8.5 Derating curve (SFS3048)

(1) Single and series operation

① Natural convection cooling (0.2m/s)

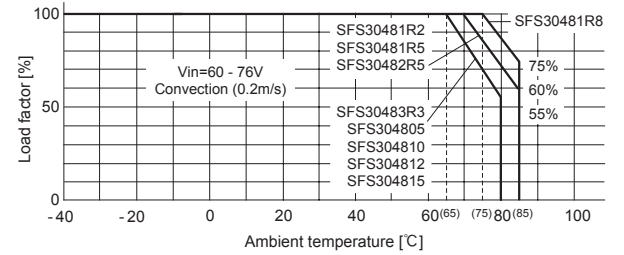
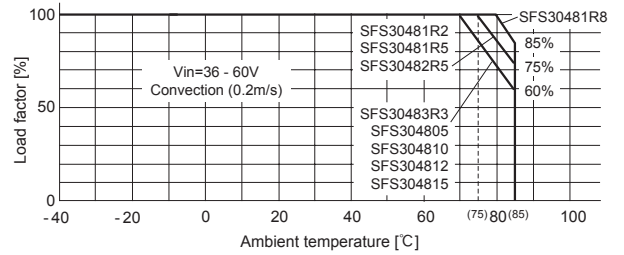

Fig.8.14 Derating curve (Convection)

② Forced air cooling (0.8m/s)

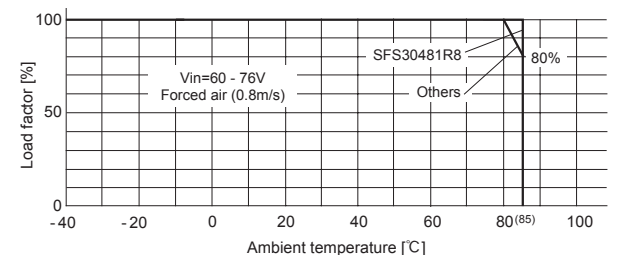
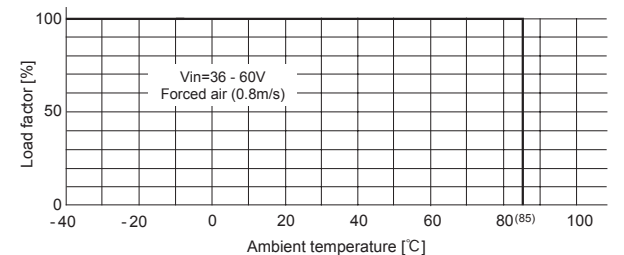

Fig.8.15 Derating curve (Forced air 0.8m/s)

③ Forced air cooling (1.2m/s)

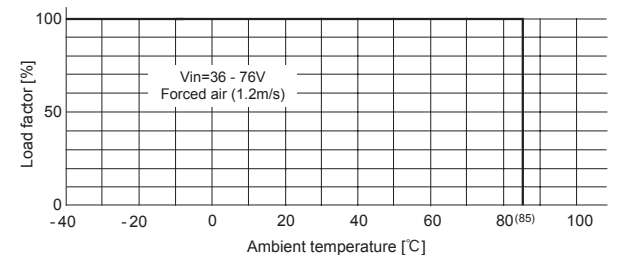

Fig.8.16 Derating curve (Forced air 1.2m/s)

(2) Parallel operation

① Natural convection cooling (0.2m/s)

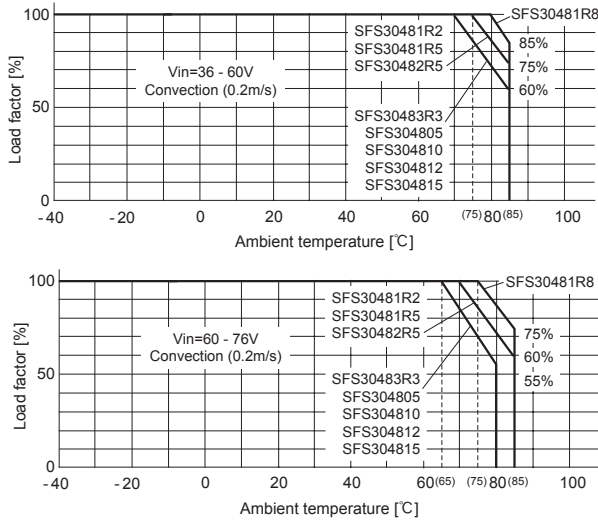

Fig.8.17 Derating curve (Convection)

② Forced air cooling (0.8m/s)

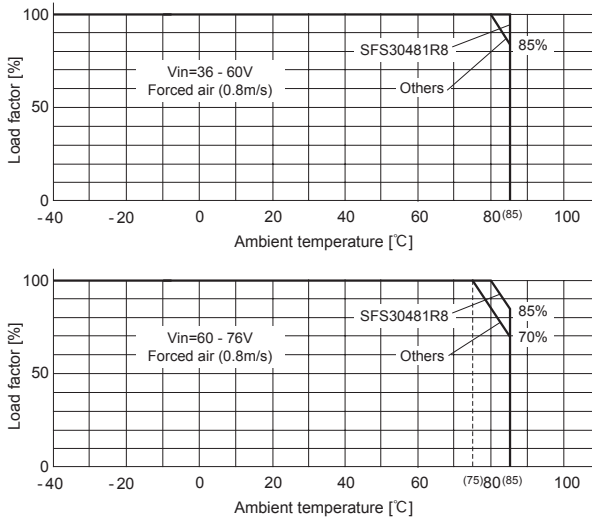

Fig.8.18 Derating curve (Forced air 0.8m/s)

③ Forced air cooling (1.2m/s)

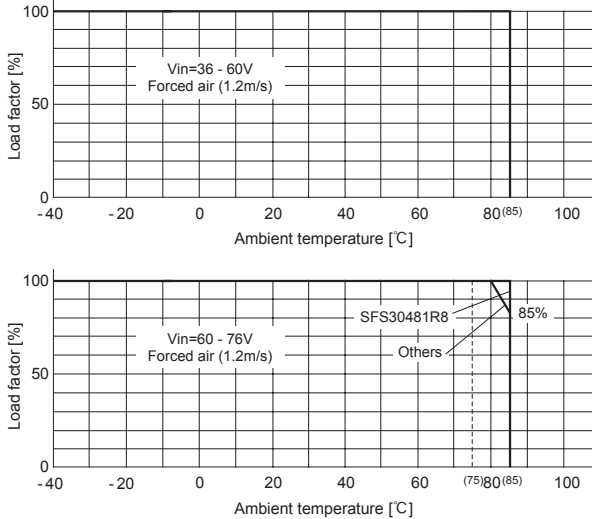

Fig.8.19 Derating curve (Forced air 1.2m/s)

(3) Measuring point in forced air cooling

■ In case of forced air, ventilation must keep the temperature of point A and B below 120°C. Refer to Fig.8.20 for the location of point A and B.

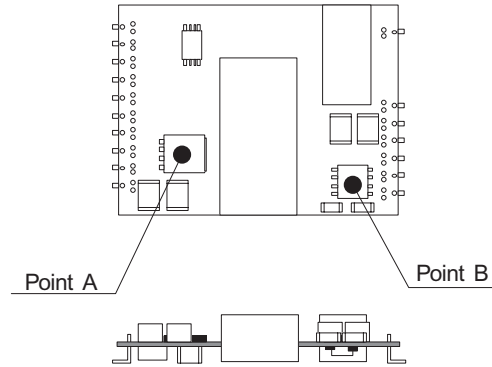

Fig.8.20 Location of point A and B

9 SMD type Package Information

9.1 Delivery package information (SFS series SMD type)

- These are packed in a tray (Fig.9.1, 9.2).
 - Capacity of the tray is 15 max.
- In case of fractions, the units are stored in numerical order.

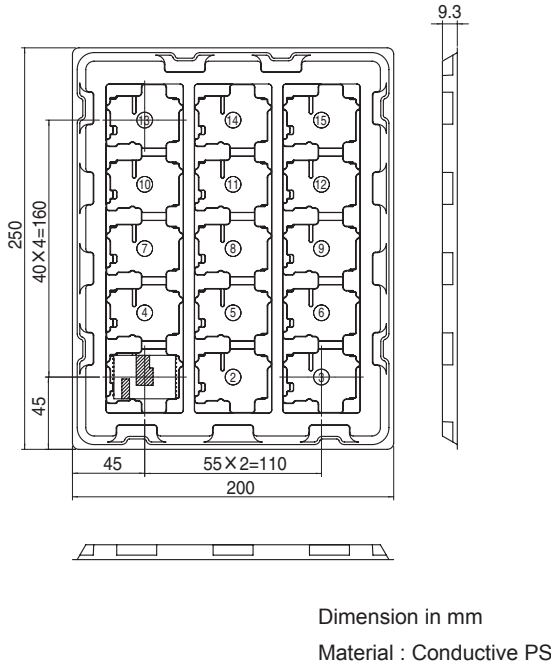

Fig.9.1 Delivery package information(SFS10/SFS15/SFS20)

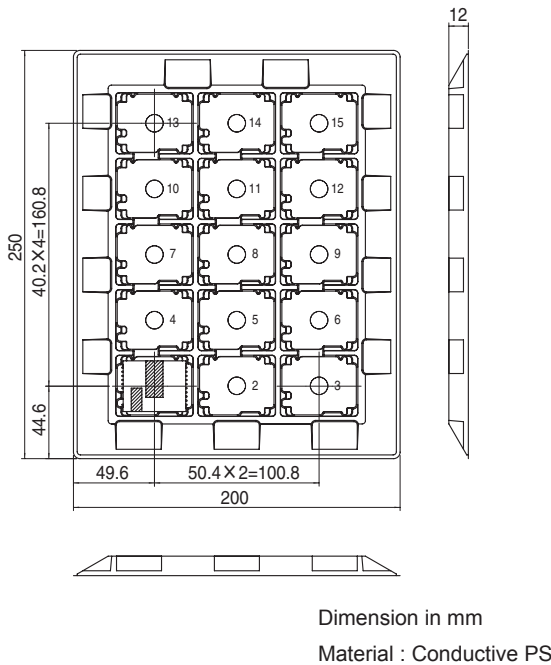

Fig.9.2 Delivery package information(SFS30)

- Tray is stacked with alternating opposite direction to prevent products from contacting against the bottom of trays.
- Do not cut or deform the tray.

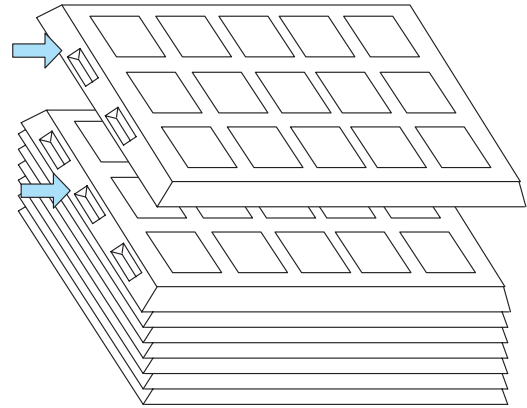

Fig.9.3 Stacking pattern of trays

9.2 Delivery package information (SFCS series SMD type)

- These are packed in a tray (Fig.9.4).
- SFCS15 and SFCS30 can be used in the same pallet tray. But the orientation of the power supplies is different.
- Capacity of the tray is 10 max.
- In case of fractions, the units are stored in numerical order.
- Do not cut or deform the tray.

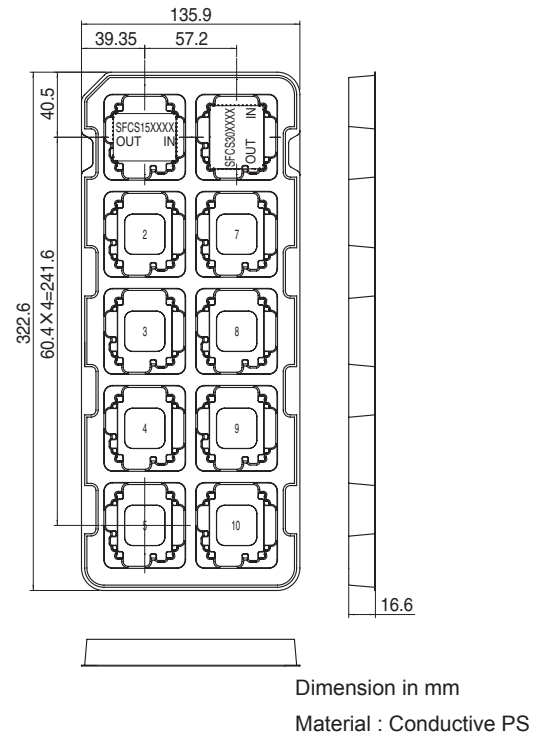

Fig.9.4 Delivery package information(SFCS15/SFCS30)